

User Manual *Installation and Operating*

RT-300

2-Band Precision Bearing System

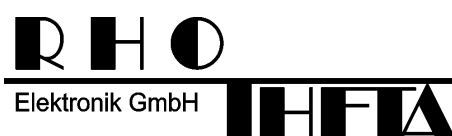

Edited by:

RHOTHETA Elektronik GmbH
Dr.-Ingeborg-Haeckel-Str. 2
D-82418 Murnau
Germany

Email: email@rhotheta.de

Homepage: www.rhotheta.de

*Copyrights © RHOTHETA Elektronik GmbH
All rights reserved
Document Number: 12-9-1-0013-3-1-61
Issue: 2022/01/14 [Rev 1.06.b]*

NOTE

The manufacturer reserves on making modifications at any time and without previous information of the here described product.

Table of Content

1	SAFETY INSTRUCTIONS	6
1.1	Legend of Symbols	6
1.2	Basic Safety Instructions	7
2	LEGAL INFORMATION	8
2.1	EU Declaration of Conformity	8
2.2	Legal Limitations of Use within the EU	8
2.3	FCC Information (USA)	8
2.4	Industry Canada compliance (ISED)	9
3	GENERAL INFORMATION	10
3.1	Purpose of Use	10
3.1.1	Mobile Use	10
3.1.2	Stationary Use	10
3.2	Content of Delivery	10
3.3	Front View DCU (Display Control Unit)	11
3.4	Brief Summary DCU	11
3.5	Rear View DCU	13
4	TECHNICAL DATA	14
4.1	Electrical Characteristics	14
4.2	Mechanical Characteristics	16
4.2.1	DCU	16
4.2.2	Antenna	17
5	DISPLAY AND OPERATING	18
5.1	Display	18
5.1.1	LED-Circle	18
5.1.2	General Lighting	18
5.1.3	LC -Graphic-Display	19
5.1.4	Digital Bearing Value Display	19
5.1.5	Direction of Reference	19
5.1.6	Display of Signal Level	20
5.1.7	Squelch Level	20
5.1.8	Frequency / Channel Display	20
5.1.9	Status Display	20
5.1.9.1	Warning	20
5.1.9.2	“ERROR“ Message	21
5.1.10	SCAN-Display	22
5.1.11	Selective Squelch (only ELT)	22
5.1.12	Status Alarm Contact	22
5.2	Operating the Bearing System RT-300	22
5.2.1	Switching On and Off: Key 1: On/Off	22
5.2.1.1	Switching On	22
5.2.1.2	Switching Off	22
5.2.1.3	External Switching On/Off	23

5.2.2	Switching the Band: Key 16 < Band >	23
5.2.3	Selection of Frequency / Channel: Key 15 < Channel / Frequ. >	23
5.2.4	Squelch Function: Key 14 < Squelch >	24
5.2.4.1	Common Remark	24
5.2.4.2	Adjusting the Squelch	24
5.2.5	Volume: Key 5 < Vol.+ > and 10 < Vol.- >	25
5.2.6	„Selective Squelch“: Key 4 < ELT only >	25
5.2.6.1	Common Remark	25
5.2.6.2	Activating / Deactivating „Selective Squelch“	26
5.2.7	Scan Function: Key 12 < Scan >	26
5.2.7.1	Common Remarks	26
5.2.7.2	Activating Scanning Function	27
5.2.7.3	Deactivating Scanning Function	27
5.2.8	Function Repeat: Key 3 < Repeat >	27
5.2.9	Function Live: Key 8 < Live >	28
5.2.10	Function Clear: Key 9 < Clr >	28
5.2.11	BID-Indicator	28
6	THE MENU	29
6.1	The Menu Structure	30
6.2	The Main Menu	31
6.2.1	Structure	31
6.2.1.1	Menu LIGHT/LCD	32
6.2.1.1.1	Adjusting Brightness of LC- Display: Function DIM LCD	32
6.2.1.1.2	Adjusting Brightness of Keyboard Lighting: Function DIM LEGEND	33
6.2.1.1.3	Adjusting Brightness of LED-Circle: Function DIM CIRCLE	33
6.2.1.1.4	Adjusting Contrast of the LC-Display: Function LCD CONTRAST	33
6.2.1.2	Menu: BEARING	34
6.2.1.2.1	Selecting Bearing Reference Direction: Selecting Function BEARING TYPE	34
6.2.1.2.2	Display Bearing Parameters: VIEW BEARING SETUP	37
6.2.1.3	Menu: INFO	37
6.2.1.3.1	INFO Beacon	37
6.2.1.3.2	INFO Receiver	38
6.2.1.3.3	INFO DCU (Display Control Unit)	38
6.2.1.3.4	INFO Statistics	38
6.2.1.4	Menu: SOUNDS	39
6.2.1.4.1	Adjusting Key Volume: Function BEEP VOLUME	39
6.2.1.4.2	Adjusting Volume Alarm Signal: Function ALARM VOLUME	39
6.2.1.5	Menu: SETUP	40
6.2.1.5.1	SETUP-Menu BEARING	40
6.2.1.5.2	SETUP Menu RECEIVER	45
6.2.1.5.3	SETUP Menu: SERIAL	47
6.2.1.5.4	SETUP Menu: COMPASS	50
6.2.1.5.5	SETUP Menu: OTHER	56
6.2.1.5.6	SETUP Menu: FACTORY RESET	58
6.2.1.6	MENU: SERVICE	60
6.2.1.6.1	Service Menu: BEARING	60
6.2.1.6.2	Service Menu: RECEIVER	61
6.2.1.6.3	Service Menu: DCU	61
6.2.1.6.4	Service Menu: COMPASS	62
6.2.1.6.5	Service Menu: REBOOT	62

6.3	Special Functions	63
6.3.1	Locking / Unlocking the Setup Menu	63
6.3.2	Resetting Brightness and Contrast Adjustment of Display	63
6.3.3	Loading Firmware Updates	63
6.4	Interfaces	63
6.4.1	Antenna Connector on DCU	63
6.4.2	Power Connector	64
6.4.2.1	Power Supply	65
6.4.2.2	External Speaker	66
6.4.2.3	Alarm Contact	66
6.4.2.4	Extern Input	66
6.4.2.5	Analog Test	66
6.4.3	Interface Connector	66
6.4.3.1	RS-232-Interface	67
6.4.3.2	RS-485-Interface	67
6.4.3.3	NMEA (RS-422) Interface	67
7	INSTALLATION AND PUTTING INTO OPERATION	68
7.1	Installation of Display-Control-Unit DCU	68
7.1.1	DCU Installing Cut-Out	68
7.1.2	Connecting Power Supply	69
7.1.3	Connecting the DCU to Ground	69
7.1.4	Connecting Antenna	70
7.2	Determination of Antenna Position	70
7.3	Completing Antenna Cable	71
7.3.1	Type of Cable	71
7.3.2	Connecting Pattern of Antenna Cable:	72
7.4	Installing the Antenna	73
7.4.1	Fixing Screw Joint on Mast Tube	74
7.4.2	6-Holed Mast Flange	74
7.4.3	Installing Antenna Cable with Pull-Relief	74
7.4.4	Fixing the Antenna	74
7.4.5	Aligning Antenna for Mobile Use	74
7.4.6	Aligning Antenna for Stationary Use	75
7.4.7	Mounting of Antenna Beams	76
7.5	Configuring Setup	77
8	MAINTENANCE AND CLEANING	79
8.1	Maintenance	79
8.2	Cleaning	79
9	PRODUCT DISPOSAL	80
9.1	Disposal within the European Union	80
9.2	Disposal outside the European Union	80
10	APPENDIX	81
10.1	Wiring Pattern (recommended RT-300 DCU connections plan)	81

1 Safety Instructions

RHOTHETA Elektronik GmbH is constantly trying to keep the safety standard of the products up to date and to offer the customers the highest possible level of security.

RHOTHETA products are designed and tested in accordance with the valid safety regulations. The compliance with these standards is continuously monitored by our quality assurance system. This product is manufactured in accordance with the EC Certificate of Conformity, tested and left the factory in perfect technical and safety-relevant condition.

To maintain this condition and to ensure safe operation, the user must pay attention to all instructions and warnings given. For any questions regarding these safety instructions, RHOTHETA Elektronik GmbH can be contacted at any time.

The observance of the safety instructions will help to prevent personal injury or damage caused by all kinds of dangers. This requires that the following safety instructions must be read carefully and understood before using the product, as well as observed when using the product. The additional safety instructions such as for protecting persons appear in relevant parts of the product documentation and must also be paid attention to.

In addition, it is the responsibility of the user to use the product appropriately. The product RT-300, a dual-band direction finder system RT-300 may not be used in any way that a person / thing is injured or damaged.

The use of this product other than its designated purpose or in disregard of the instructions of the manufacturer is the responsibility of the user. The manufacturer takes no responsibility for the misuse of the product.

The manufacturer is not liable beyond the scope of legal rules!

This guide is part of the product RT-300 and is retained throughout the lifetime and to pass with the product.

1.1 Legend of Symbols

NOTE

This symbol designates tips or additional notes that must be paid attention to and make work easier.

ATTENTION

means that ignoring the instructions may lead to property damage or loss of data.

WARNING

means that ignoring the instructions, there may a danger to health or life.

1.2 Basic Safety Instructions

ATTENTION

Read and observe the following instructions, warnings and safety instructions of the manufacturer!

- At all work, the local or national safety and accident prevention regulations must be observed.
- Use only the manufacturer prescribed components and / or use only recommended material by the manufacturer and do not change this.
- Connect only approved accessories kits or additional equipment.
- The product may only be opened by authorized service personnel.
- The unit voids its type approval on operating with unauthorized modifications on the device or not the intended use.

2 Legal Information

2.1 EU Declaration of Conformity

Hereby RHOTHETA Elektronik GmbH declares that the product RT-300 is in compliance with the essential requirements and other relevant provisions of:

- Directive 2014/53/EU relating to radio equipment (relevant for RT-300 AU)
- Directive 2014/30/EU relating to electromagnetic compatibility (relevant for RT-300 DCU)
- Directive 2014/35/EU relating to the making available on the market of electrical equipment designed for use within certain voltage limits (relevant for RT-300 DCU)
- Directive 2011/65/EU on the restriction of the use of certain hazardous substances in electrical and electronic equipment (relevant for RT-300 AU and RT-300 DCU)

The full text of the Declaration of Conformity can be found at:

http://www.rhotheta.com/products/rt_300

2.2 Legal Limitations of Use within the EU

Due to its conformance to “Directive 2014/53/EU on the harmonisation of the laws of the Member States relating to the making available on the market of radio equipment and repealing Directive 1999/5/EC”, declared in the EU declaration of conformity, the equipment may be used within the European Union without limitations regarding the use of frequencies in those countries.

Please also consider national limitations or requirements for special operational permissions in your country.

2.3 FCC Information (USA)

Changes or modifications not expressly approved by the party responsible for compliance (RHOTHETA) could void the user's authority to operate the equipment.

NOTE

This device complies with part 15 of the FCC Rules. Operation is subject to the following two conditions:

- (1) This device may not cause harmful interference, and
- (2) this device must accept any interference received, including interference that may cause undesired operation.

NOTE

This equipment has been tested and found to comply with the limits for a Class B digital device, pursuant to part 15 of the FCC Rules. These limits are designed to provide reasonable protection against harmful interference in a residential installation. This equipment generates, uses, and can radiate radio frequency energy and, if not installed and

used in accordance with the instructions, may cause harmful interference to radio communications. However, there is no guarantee that interference will not occur in a particular installation. If this equipment does cause harmful interference to radio or television reception, which can be determined by turning the equipment off and on, the user is encouraged to try to correct the interference by one or more of the following measures:

- Reorient or relocate the receiving antenna.
- Increase the separation between the equipment and receiver.
- Connect the equipment into an outlet on a circuit different from that to which the receiver is connected.
- Consult the dealer or an experienced radio/TV technician for help.

2.4 Industry Canada compliance (ISED)

This device contains a licence-exempt receiver that complies with Innovation, Science and Economic Development Canada's licence-exempt RSS. Operation is subject to the following two conditions:

- (1) This device may not cause interference.
- (2) This device must accept any interference, including interference that may cause undesired operation of the device.

L'émetteur/récepteur exempt de licence contenu dans le présent appareil est conforme aux CNR d'Innovation, Sciences et Développement économique Canada applicables aux appareils radio exempts de licence. L'exploitation est autorisée aux deux conditions suivantes:

- (1) L'appareil ne doit pas produire de brouillage;
- (2) L'appareil doit accepter tout brouillage radioélectrique subi, même si le brouillage est susceptible d'en compromettre le fonctionnement.

3 General Information

3.1 Purpose of Use

3.1.1 Mobile Use

The RT-300 bearing system allows bearing of radio signals (radio telephony) in the maritime band (156,000 – 162,300 MHz) as well as bearing of signals on the international VHF distress frequency 121,500 MHz.

For training purposes a whole frequency range of the airband 118,800 ... 124,000 MHz is tuneable.

Integrating a communication bearing system for coastal and maritime radio stations and a professional SAR-bearing system, the RT-300 bearing system allows quick bearing and detecting of EPIRB equipped persons or vessels.

Especially designed for use under rough circumstances on sea vessels the system is extremely compact. The antenna and the display control unit are waterproof. The most sensitive receiving system allows bearing of weakest signals.

ATTENTION

The bearing system RT-300 is not approved for primary navigation purposes.

3.1.2 Stationary Use

As traffic bearing system the RT-300 has a wide range of use, e.g. surveillance of coastal shipping traffic as well as alerting rescue crews in case of accident.

3.2 Content of Delivery

- 1 User Manual
- 1 Display Control Unit DCU
- 1 Antenna Unit AU
- 1 Pull-relief
- 1 Mounting kit
- 1 Connecting cable, D-SUB, 9-pole
- 1 Power supply cable including fuse holder
- 8 Antenna beams, \varnothing 6 mm, length 30 cm
- 1 Fastening kit incl. 1 spare fuse (1A inert)
(4 fixing bolts M4x30 DIN 912 + 4 washers M4 + 4 lock washers + 4 nuts M4)
- 1 DCU installing cut-out
- 2 D-SUB plug male
- 2 D-SUB plug female
- 1 Documentation "RT-300 NMEA Serial Communication & Remote Control"
- 1 Test protocol (signed and stamped)

3.3 Front View DCU (Display Control Unit)

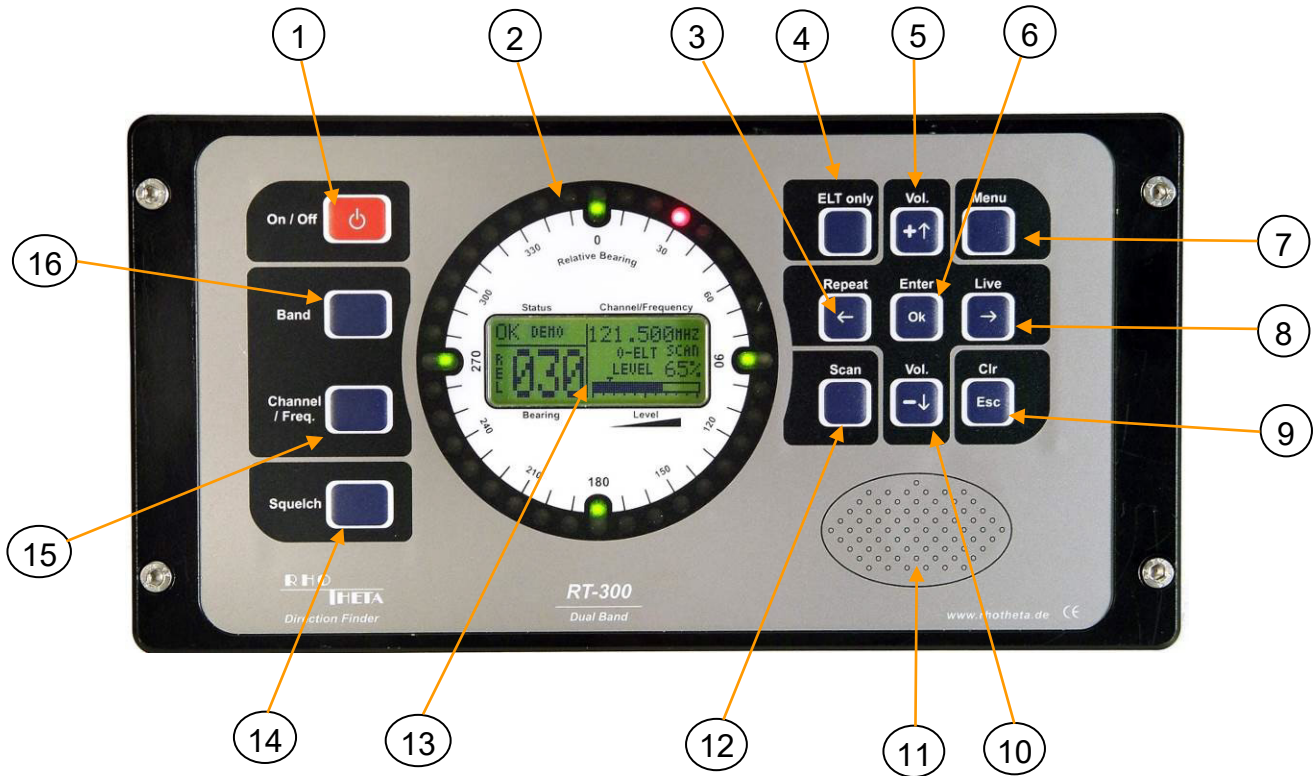
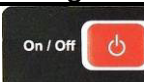













Fig. 1: Front view

3.4 Brief Summary DCU

Pos.	Designation	Function	see chapter
01		Switching on and off the bearing system	5.2.1
02	LED-circle	Indicates RB (RB = relative bearing) resolution 10°	5.1.1
03		Repeat: Bearing-mode, indicates last bearing value during signal pauses ← : - In menu-mode: moves selecting field to the left - In adjusting-mode: sets value to minimum - In frequency-/ channel-selecting-mode: moves decimal to the left	5.2.8
04		Bearing-mode: Activating of „selective squelch“. (bearing and alerting functions will only be working if ELT modulation is recognized). Function only available in airband.	5.2.6
05		Vol. + : In bearing-mode: increases audio-volume ↑ : - In menu-mode: moves selecting field upwards - In adjusting-mode: increases value for one step	5.2.5

Pos.	Designation	Function	see chapter
06		Confirms input or selection	
07		Call-up menu or leaving menu	6
08		<p>Live : In bearing-mode: displaying unaveraged bearing values, if key is pressed.</p> <p>→ : - In menu-mode: moves selecting field upwards - In selecting-mode: increases value to maximum - In frequency-/ channel-selecting-mode: moves decimal to the right</p>	5.2.9
09		<p>Clr : In bearing-mode: cancelling bearing average store</p> <p>Esc : In selecting-mode: jumps to next higher level In adjusting-mode: ignores last not confirmed input and jumps to next higher level</p>	5.2.10
10		<p>Vol. - : In bearing-mode: decreases audio volume</p> <p>↓ : In menu-mode: moves selecting field downwards</p> <p>: In adjusting-mode: decreases value for one step</p>	5.2.5
11	Speaker	Internal speaker output	
12		In bearing-mode: activating and de-activating of scan-function (confirming with "OK")	5.2.7
13	LC-Display	<p>Depending of operating mode display of following information:</p> <p>bearing mode:</p> <ul style="list-style-type: none"> - bearing value - reference direction - signal strength - squelch threshold - active frequency / channel - status report - time since last bearing - scan function - "selective squelch" (ELT only) <p>selecting-mode: - Menu (Menu) - menu level</p> <p>adjusting-mode: - adjusting range / menu - limit values - active buttons</p>	5.1.3
14		Activating squelch adjusting mode	5.1.7
15		Activating mode for channel selection (maritime band) or frequency selection (airband)	5.2.3
16		change-over between maritime band and airband	5.2.2

3.5 Rear View DCU

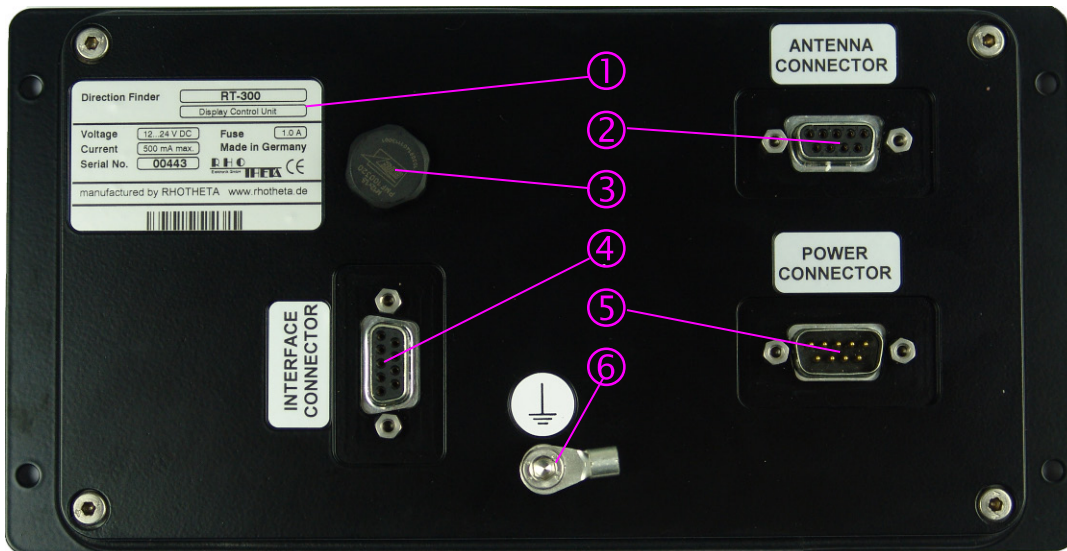

Fig. 2

Pos.	Designation
①	Type plate
②	Antenna connector
③	Ventilation
④	Interface connector
⑤	Power supply connector
⑥	Ground (Gnd)

4 Technical Data

4.1 Electrical Characteristics

Designation	Value	Remarks
Bearing principle	Doppler	3 kHz rotational frequency, delay time compensation
Direction of bearing reference, digital display	- REL - MAG - TRU	- to antenna direction - relative to magnetic north - relative to geographic north
Direction of bearing reference LED-circle	relative	- to antenna direction
bearing error	$\leq 5^\circ$ RMS	in undisturbed wave field, sufficient field strength assumed, signal without modulation.
Resolution		
Digital display LED-circle	1° 10°	
LC-graphic-display	98x32 dots	brightness and contrast adjustable
Sensitivity		typical values, measured in undisturbed wave field, with unmodulated continuous signal
Airband: Maritime band:	0,7 μ V/m 2 μ V/m	
Frequency range		
Airband: Maritime band:	118,800 ... 124,000 MHz 156,000 ... 162,300 MHz	channel 0 (ship) – 88 (coast)
Channel pattern	25 KHz	
Bearable types of modulation	A3E; F3E, A3X (ELT-modulation)	bearing largely independent of type of modulation
Polarisation	vertical	
Polarisation error	$\leq 5^\circ$	at 60° rotation of field vector
Cone of silence	ca. 30° to the vertical	additional bearing error $\leq 5^\circ$
time of response	≤ 300 ms	depending on field strength of signal
Audio-output	max. 1,5 W at 4 Ohm	
operating temperature range	DCU: -20° ... +60° C AU: -40° ... +60° C	at low temperatures running in time up to 5 minutes
Range of operating voltage	12 ... 28 Volt DC	

Designation	Value	Remarks
Current consumption	at 12V DC voltage supply: 350 mA (4,2 W) 400 mA (4,8 W) 450 mA (5,4 W) 600 mA (7,2 W) 800 mA (9,6 W) bei 28V Versorgungsspannung: 250 mA (7,0 W) 300 mA (8,4 W) 350 mA (9,8 W) 400 mA (11,2 W) 600 mA (16,8 W)	<ul style="list-style-type: none"> - standby - typ. without ext. speaker - max. without ext. speaker - typ. with ext. speaker - max. with ext. speaker <ul style="list-style-type: none"> - standby - typ. without ext. speaker - max. without ext. speaker - typ. with ext. speaker - max. with ext. speaker

4.2 Mechanical Characteristics

4.2.1 DCU

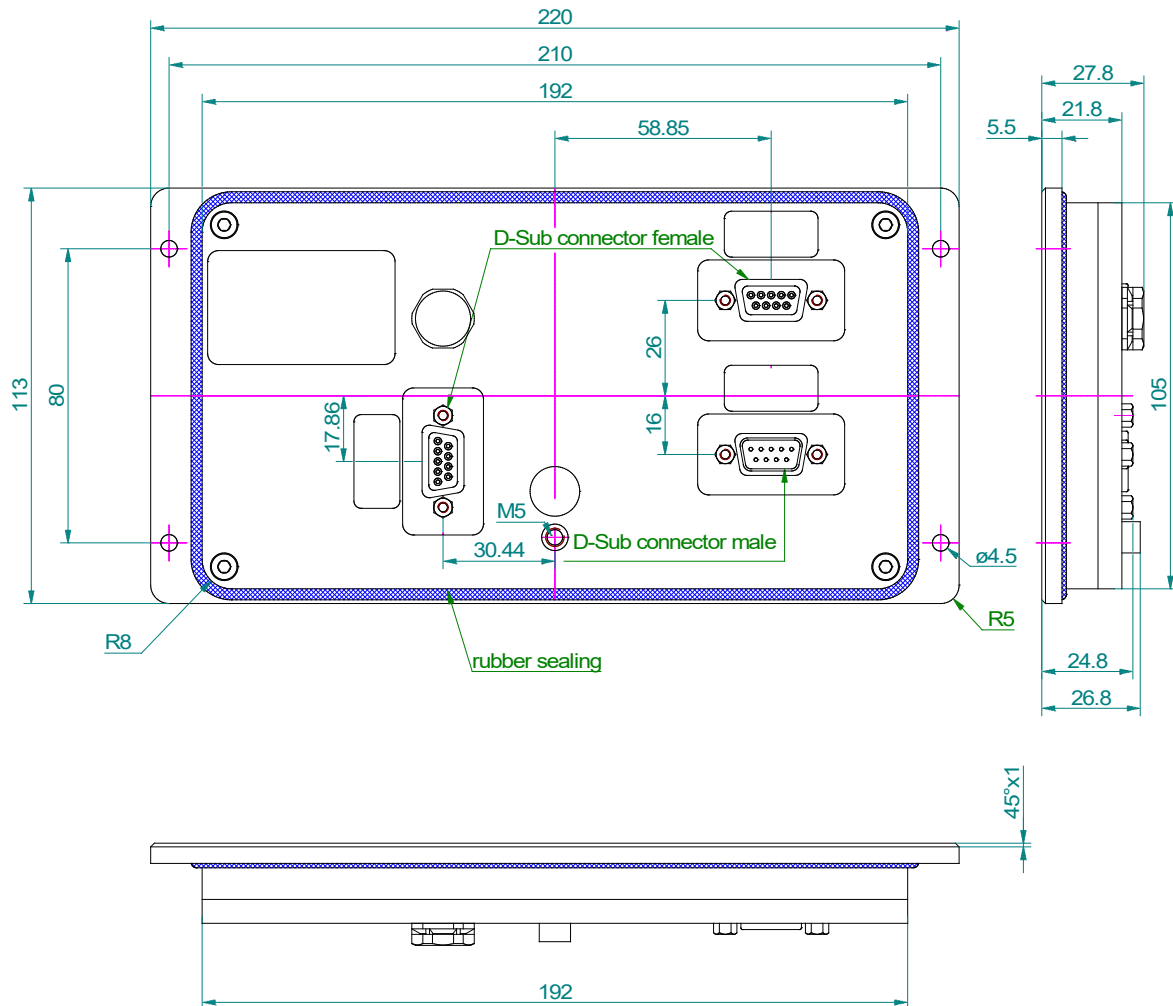

Fig. 3

Weight: ca. 700 g

Dimensions: see Fig. 3

Protection of housing: IP 67

4.2.2 Antenna

Weight: ca. 1400 g

Dimensions: see Fig. 4

Protection of housing: IP 67¹

Antenna beams: 8 pcs. (4 dipoles)

The mast flange ② can be changed by loosening the 6 domed nuts ①.

ATTENTION
Warranty is expiring if opening the antenna.

The bearing antenna is available with 2 different antenna flanges:

1. Threaded flange (see Fig. 6)
2. 6-hole flange (see Fig. 5)

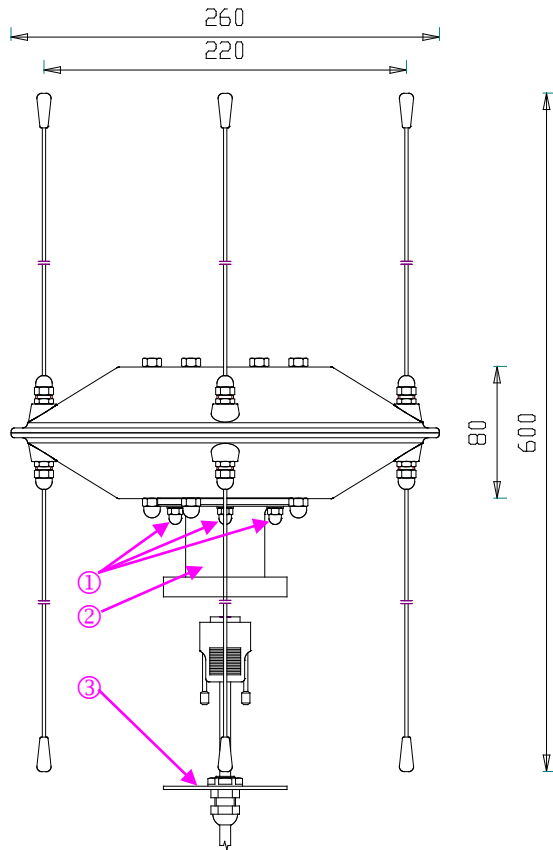

Fig. 4

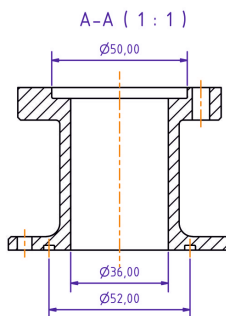
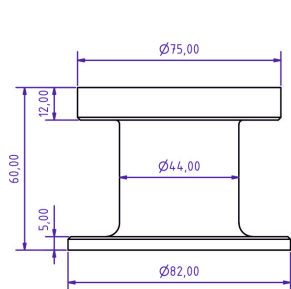
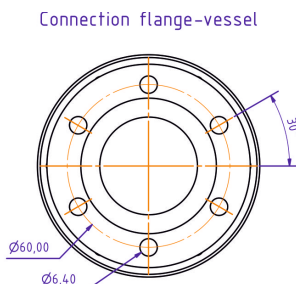
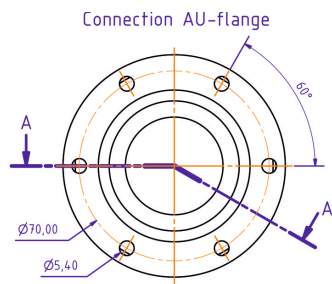

Fig. 5

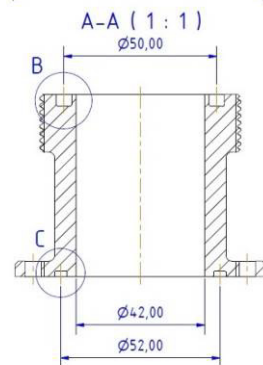
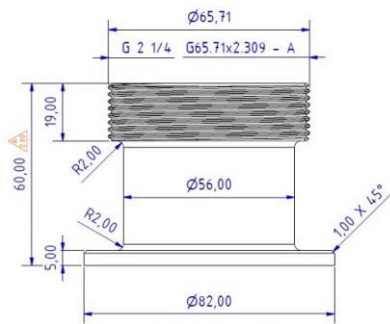

Fig. 6

¹ sealed housing flange (e.g. if using pull-relief ③ Fig. 4)

5 Display and Operating

All display and operating elements are situated on the front of the **Display-Control-Unit (DCU)**.

5.1 Display

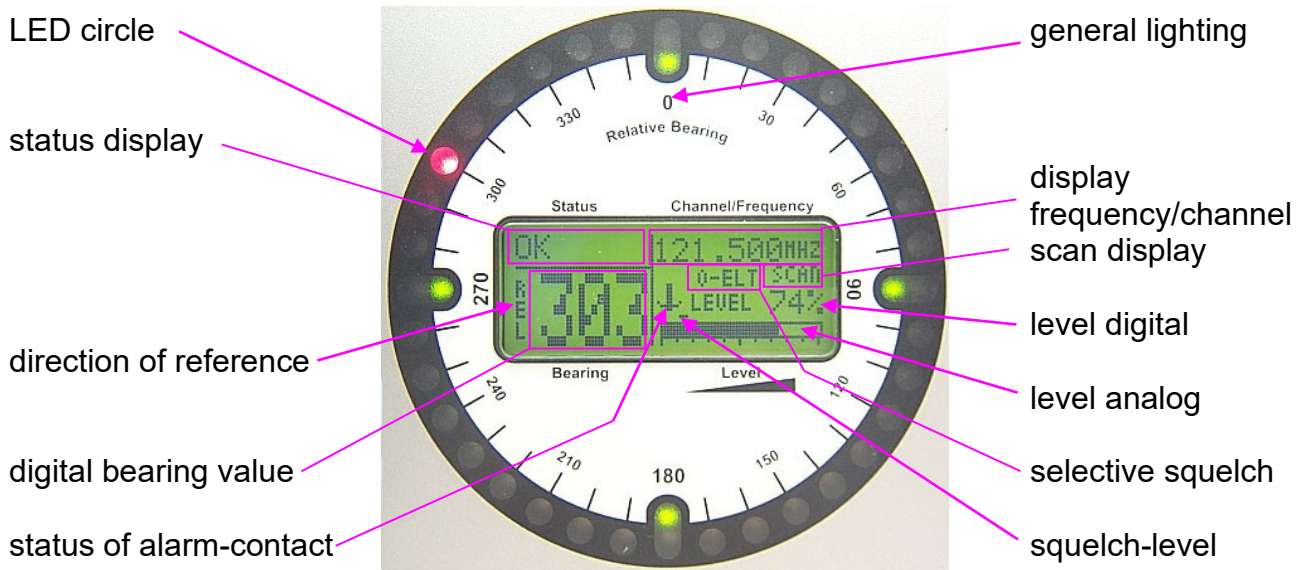

Fig. 7: Display

5.1.1 LED-Circle

Corresponding to a resolution of 10° , the LED-circle is made of 36 red LED's. The reference direction of the display is always relative to the bearing antenna and therefore to the longitudinal axle of the vessel. The preset offset-value will be considered in the display. Brightness of the display may be adjusted in submenu *LIGHT - DIM CIRCLE*. Receiving a signal, the bearing value will be displayed with the corresponding LED. If the signal isn't received anymore for a certain time, the last bearing value will be displayed with the corresponding LED flashing. This time may be adjusted in the submenu *SETUP - BEARING - LAST TIME*.

5.1.2 General Lighting

There are 4 green LEDs within the LED-circle as an orientating aid. They are placed in the directions north, east, south and west. The brightness of these green and red LEDs may be adjusted in submenu *LIGHT - DIM CIRCLE*.

5.1.3 LC -Graphic-Display

The centered LC-Display is showing all relevant bearing data, adjustments and status reports. Background brightness may be adjusted in submenu *LIGHT/LCD - DIM LCD*, contrast in submenu *LIGHT/LCD - CONTRAST*.

When adjusting, the range of adjustment will be displayed as well as the active keys and their function:

- In menu-mode all selecting fields and adjustments are displayed.
- In bearing-mode the graphic display is divided into following fields:
 - bearing value digital
 - direction of reference
 - signal level
 - squelch-level
 - frequency- / channel-display
 - status-display
 - SCAN-display
 - selektiver squelch (only ELT)
 - status of alarm-contact

5.1.4 Digital Bearing Value Display

Receiving a bearable signal, the bearing value will appear in the display's lower left area as a 3-digit figure with a resolution of 1°. If there is no more signal available, the display will start flashing for a certain time, alternately showing in the display „LAST“ (adjustable in submenu: *SETUP - BEARING - LAST TIME*). After that the information, „last bearing“ will be shown for 10 min, indicating the duration since the last bearing. After 10 min without signal three dashes are displayed.

Indicating 28 sec since last bearing



Fig. 8



Fig. 9

5.1.5 Direction of Reference

The selected direction of reference is displayed left of the digital bearing value.



Fig. 10

Following directions of reference may be selected:

Display	Direction of reference	Remarks
REL	relative	bearing relative to longitudinal axis of antenna (north – south)
MAG	magnetic north	bearing relative to magnetic north → optional internal compass module required or → compass information via NMEA interface required, input of variation (see 6.2.1.5.4.5.3)

Display	Direction of reference	Remarks
TRU	true (geographic) north	bearing relative to geographic north optional internal compass module required or → compass information via NMEA interface required, input of variation(see 6.2.1.5.4.5.3)

5.1.6 Display of Signal Level

The present signal level is displayed as figures (0..99%) as well as an analog bar graph. The display is not calibrated and is serving as a qualitative measure.



Fig. 11

5.1.7 Squelch Level

The small triangle on top of the bar graph (see Fig. 11) is the selected squelch level. Is the bar graph of the level-display left of the triangle, receiving is switched off.

5.1.8 Frequency / Channel Display



Fig. 12

The upper right area of the display is showing the present working frequency or the present selected channel in the maritime band. If a duplex channel is selected, additional information is given: "SHIP" for a maritime radio station (lower band) or "COAST" (upper band) for the coastal radio station.

The working frequency in the maritime band will be displayed, if option *CHANNEL MODE OFF* in submenu *SETUP -RECEIVER - CHANNEL* is selected.

5.1.9 Status Display



Fig. 13

The upper left area of the display is showing status information. The bearing system is verifying continuously different parameters and signals. If everything is working correctly, the information "OK" will be displayed.

If one or more parameters are leaving the permitted range of values, a warning message or error message is displayed.

5.1.9.1 Warning

A warning message is displayed, if working parameters are nearing significantly close to the permitted limit value, or if external bearing signals are not available anymore. The system's basic functions are not affected yet, but preventive measures are recommended.

A warning is displayed in the status field with the letter "W" followed by an error indicating figure. After that a short characterization of the warning is displayed.

At warnings, indicating the missing of a required signal, the warning message is displayed additionally as a text instead of the digital bearing value.





Following warning messages may be displayed:

Warning	Short designation	Meaning
W1	U-DISP	Voltage supply too low
W2	U-REC	Antenna voltage too low
W3	NO HEAD	No heading data available
W4	NO COMP	No compensation of drag error, selected data source not available or faulty data

5.1.9.2 “ERROR” Message

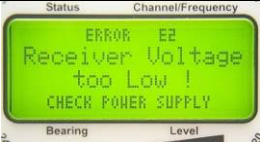
An error message is indicated, if one or more operating parameters have left the permitted range, or if the internal electronics have detected a malfunction. In this case the bearing system is out of order.

Following errors may be detected by the internal electronics:

Error	Display message	Meaning
E1		Operating voltage in display is too low
E2		Operating voltage in antenna unit is too low
E3		<ul style="list-style-type: none"> - no antenna connected - malfunctioning connection AU - DCU - defective antenna
E4	BAD ANT	Faulty data from antenna to DCU
E5	BAD DCU	Faulty data from DCU to antenna
E6	PLL-LO	frequency adjustment in receiver module is not working
E7	PLL-SY	synthesizer of receiver is not working
E8	--	Not in use now
E9		Frequency of received signal is above permitted range
E10		Frequency of received signal is under permitted range

5.1.10 SCAN-Display

As soon as the scanning mode is activated, on the right hand side of the frequency display „SCAN“ will appear (see Fig. 7). In the scanning mode, the receiver will be switched to the distress frequency 121.500 MHz every 40 sec for a duration of 10 sec, in order to receive transmitted distress signals. During this time the message **SCAN** is displayed inverted, the frequency display is showing 121.500 MHz.

5.1.11 Selective Squelch (only ELT)

The activated function “Selective Squelch (only ELT)” is indicated as „O-ELT“ beneath the frequency display (see also 5.2.6). If this function is activated, only transmitters in the airband sending the normed ELT-sweep-tone will be received.

5.1.12 Status Alarm Contact

If the function „ELT-PULS (MOB)“ in the submenu *SETUP - OTHER - RELAY - MODE* is selected, the anchor symbol is indicating the recognized alarm and that the relay has made contact one time. In order to release this function again, the bearing system has to be switched off and on again (see 6.2.1.5.5.1).

5.2 Operating the Bearing System RT-300

The bearing system can be controlled by using the 13 keys on the front of the DCU. Functions needed for normal bearing operation can be called up directly by function keys. Functions rarely to be changed or functions to be adjusted once during installation are selected in the menu structure.

5.2.1 Switching On and Off: Key 1: On/Off

Using key 1 < On/Off > (see

Fig. 1: Front View DCU), you can switch on and off the device.

5.2.1.1 Switching On

Pressing key 1 < On/Off > for at least 1 sec this is activating the device. For about 1,5 sec the display as shown in Fig. 14 will appear. Now the system is ready to work. Depending on previous menu adjustments the manufacturer’s defaults or the last selected adjustments (setups) will be active.



Fig. 14

5.2.1.2 Switching Off

Pressing key 1 < On/Off > is closing the system. This procedure will last 3 sec. The LC-display will show “shutting down”.

5.2.1.3 External Switching On/Off

Separating the system from the power supply will close down the system automatically, saving all adjustments automatically. The operating voltage applied again, the system is returning to the last stage before shutting down. If the system was switched on before separating from the operating voltage, it will be switched on after applying the operating voltage. If it was switched off, it will remain switched off.

5.2.2 Switching the Band: Key 16 < Band >

The bearing system is able to receive and to bear frequencies in two different bands. The standard version is covering the whole maritime band (156.000 ... 162.300 MHz) as well as a certain frequency range in the airband (118.800 ... **121.500** ... 124.000 MHz) where the international distress frequency is located.

- Pressing key 16 < Band >, the menu for selecting the frequency band will appear in the LC-display (see Fig. 15 and Fig. 16).
- Use keys 5 < + >, 10 < - >, 3 < ← > or 8 < → > to select one of the two bands.
- The inverted band is selected.
- Use key 6 < Ok > to confirm the selection. The device is returning into bearing mode.
- If the selection has to be rejected, use key 9 < Esc >. The device is returning into bearing mode, keeping the previous adjustment.
- If the confirmation isn't executed within 16 sec, the device is returning automatically into the bearing mode, keeping the previous adjustment.
- In the third line the available frequency range is indicated.
- In the fourth line the active function keys are shown.



Fig. 15



Fig. 16

5.2.3 Selection of Frequency / Channel: Key 15 < Channel / Freq. >

Selecting the operational frequency in the airband is usually done by direct input, with an incremental width of 25 kHz. In the maritime band each frequency has an assigned channel number. Selecting the frequency in the maritime band is usually done by putting in the desired channel number. However, the direct frequency input in the maritime band can be done as shown in menu 6.2.1.5.2.

Airband:

- After pressing key 15 < Channel / Freq. > the „Set Frequency“- window will appear on the display (see Fig. 17).
- Keys 3 < ← > and 8 < → > are selecting the decimal, the location is underlined.
- Keys 5 < + > and 10 < - > are increasing respectively decreasing the corresponding value.



Fig. 17



Fig. 18

NOTE

Inputs will be accepted only in the admitted frequency range.

Maritime Band:

- After pressing key 15 < Channel / Freq. > the „Set Channel“- window will appear on the display (see Fig. 18).
- Keys 5 < + > and 10 < – > are selecting the channel.
- Key 6 < Ok > confirms the selected frequency / channel. The device is returning into the bearing mode using the selected frequency / channel.
- Key 9 < Esc > will reject the selection, and the device is returning into the bearing mode, working on the previous frequency / channel.

5.2.4 Squelch Function: Key 14 < Squelch >**5.2.4.1 Common Remark**

Our surrounding atmosphere always contains a certain electric field strength, designated as “noise”. This noise voltage, which can be received, depends on the frequency and the location of the receiver.

Interpreting signals reasonably is only possible, if their level is higher than the level of the surrounding noise. Using the squelch electronic it is possible to adjust a threshold, under which received signals will not be processed. Usually the squelch threshold is adjusted as close as possible above the noise level. In that case the bearing system will work only, if a signal is received. As long as no signal is received, the speaker is remaining mute.

NOTE

The squelch level is to be kept as low as possible in order not to suppress weak signals.

5.2.4.2 Adjusting the Squelch

The squelch level is to be adjusted, when receiving no signal.

- Pressing key 14 < Squelch > the „Adjust Squelch“- window will appear.
- Key 8 < → > is starting the automatic squelch setting procedure. For a duration of about 3 sec the signal level is measured, and then the squelch level will be set approximately 3 % above the peak value of the measuring period. After that, the „Adjust Squelch“- window will reappear.
- Using keys 5 < +↑ > respectively 10 < -↓ > the squelch level can be adjusted manually.
- The pointer on the top of the graphic display and the digital display are indicating the present level of the squelch threshold.
- Pressing key 3 < ← > disables the squelch function (level will be set to 0%).
- Key 6 < Ok > confirms the input and the device will return into the bearing mode.
- Key 9 < Esc > will reject the selection and the device will return into the bearing mode.
- If no confirmation is done within 25 sec after the last input, using key 6 < Ok >, the device will return into the bearing mode with the previous adjustment.

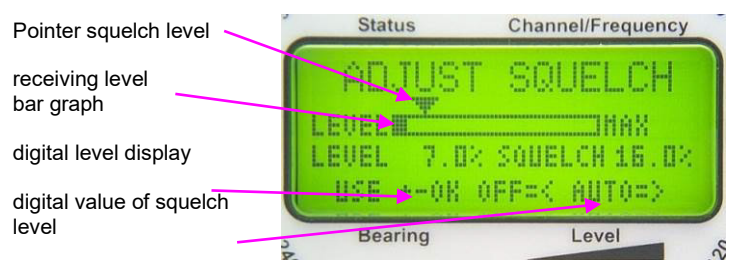
**Fig. 19**

The squelch level for the airband and for the maritime band are adjusted and saved separately. On different frequencies within the range of one band the noise level may be varying significantly. Coastal areas with industries may show higher noise levels than in offshore areas. Therefore, it is important, to periodically check the squelch adjustment, and if required to readjust the squelch level in order to acquire highest sensitivity of the bearing system.

NOTE

While bearing emergency transmitters, which are often transmitting very weak signals, it may be useful to deactivate the squelch function in order to obtain highest sensitivity of the bearing system. In this case it is important to check continuously if the transmitter is beared and not an interfering signal. This can be verified by changing the heading, causing a change of the relative bearing value. If required, actuate the "Clear"-function (see 5.2.10).

5.2.5 Volume: Key 5 < Vol.+ > and 10 < Vol.- >

Pressing key 5 < Vol.+ > respectively key 10 < Vol.- > in the bearing mode, the window „ADJUST VOLUME“ appears.

Further actuating of key 5 increases continuously and the volume key 10 decreases the volume.

Bar graph and digital display are indicating the selected percentage (see Fig. 20) of the maximal volume.

Speaker signal and external audio output are affected equally (see 6.4.2.2).



Fig. 20

5.2.6 „Selective Squelch“: Key 4 < ELT only >

5.2.6.1 Common Remark

The international distress frequency 121,500 MHz is reserved exclusively for emergency transmissions. That means, transmissions are to be sent only in case of emergency or in order to prevent an emergency. Airliners, aircrafts or vessels as well as coastal radio stations are obliged monitoring these frequencies in order to intercept distress calls.

Unfortunately the distress frequencies are misused for entertainment, from our experience about 4 to 8 times a day. In order to prevent false alarms, the bearing system RT-300 has an integrated function called “selective squelch”. If activated, all signals not transmitting the specified sweep tone for emergency transmitters will be suppressed. Depending on the field strength of the signal, the electronics takes several seconds to analyse the signal. If an emergency transmission is recognized (e.g. **Emergency Locator Transmitter**) alarm will be started. This function can only be activated for frequencies in the airband.

5.2.6.2 Activating / Deactivating „Selective Squelch“

Activating:

Key 4 < ELT only > is opening a window as shown in Fig. 21. If confirming with key 6 < Ok > within 5 sec, the “selective squelch” is activated and the device is returning in bearing mode. If not confirming within that time, the selected status will remain. The display is showing the selected function „O-ELT“(see Fig. 7: Display).

O-ELT means: **O**nly **E**mergency **L**ocator **T**ransmitter.



Fig. 21

Deactivating:

Key 4 <ELT only> is opening a window as shown in Fig. 22. Now confirming with key 6 <Ok> within 5 sec, the selective squelch is deactivated and the device is returning in bearing mode. If not confirming within that time, the selected status will remain. The display is not showing the selected function „O-ELT“(see Fig. 7: Display) anymore.



Fig. 22

NOTE

The “selective squelch” activated, only signals in the airband with the typical ELT-sweep tone modulation will be heard. All other signals will be suppressed. The “selective squelch” can only be activated in the airband.

ATTENTION

At very weak signals detection may take a certain time or even be impossible. In this case alarming is delayed or not possible.

5.2.7 Scan Function: Key 12 < Scan >

5.2.7.1 Common Remarks

The bearing system RT-300 is equipped with only one receiver. If working in the maritime band, signals in the airband cannot be recognized and vice versa. So, a certain risk exists not to receive a distress signal and not activating the alarm. In order to prevent this case the scanning function *SCAN* was installed.

If the *SCAN*-function is activated, every 30 sec the device is switching over from the working frequency to the distress frequency 121.500 MHz, but **only** during a gap of reception. Is a signal received on 121.500 MHz, the device will remain tuned on the distress frequency. The alarm contact will be actuated (see 6.2.1.5.5.1). While scanning, the message **SCAN** in the display is shown inverted, and in the frequency display 121.500 MHz will be indicated. If no signal is received, the device switches back to the previous working frequency.

NOTE

The function *SCAN* can be combined with function “selective squelch”.

5.2.7.2 Activating Scanning Function

Pressing key 12 < Scan >, the scanning window in the display is opened as shown in Fig. 23. Confirming within 5 sec with key 6 < Ok > activates the scanning function. The display „SCAN“ will appear in the LC- display. (see Fig. 7: Display).



Fig. 23

NOTE

- During the scanning process bearing isn't possible on the operating frequency.
- If a continuous signal is beared on the operating frequency, there is no scanning on the distress frequency possible (only possible in signal gaps).

ATTENTION

We strongly recommend always activating the scanning function in order to minimize the risk of missing an alarm signal.

5.2.7.3 Deactivating Scanning Function

Pressing key 12 < Scan >, the scanning window in the display is opened as shown in Fig. 24. Confirming within 5 sec with key 6 < Ok > deactivates the scanning function. The display „SCAN“ will disappear in the LC- display.



Fig. 24

5.2.8 Function Repeat: Key 3 < Repeat >

If no more bearable signal is received, the last bearing value will still be indicated for 10 sec, and then the display of the bearing value will disappear (see 5.1.4). By actuating key 3 < Repeat > the last bearing value will be shown once more.

ATTENTION

If there is no compass compensation activated (see 6.2.1.5.4), the indicated bearing value is corresponding with the vessel's heading at the time of the last bearing. If there was a change of heading in the meantime, this change has to be taken in consideration!

5.2.9 Function Live: Key 8 < Live >

The bearing system is processing 750 single bearing procedures per second. These single bearings may be varying in a significant range, depending on signal strength and modulation. The processing computer is averaging the bearing values over a certain time by the means of a special processing algorithm (see 6.2.1.5.1.1), thus achieving a fairly stabilized display.

Pressing key 8 < Live > during the bearing mode, the LED circle will indicate the unaveraged single bearing values. The range of variation of the display allows to analyse the received signal and is a measure of the bearing quality.

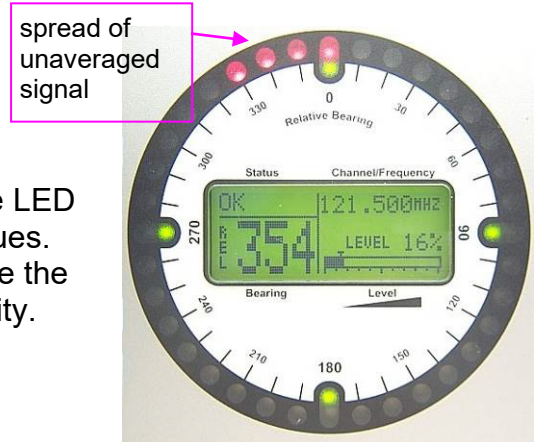

Fig. 25

5.2.10 Function Clear: Key 9 < Clr >

Actuating key 9 < Clr > during the bearing mode, the averaging memory will be cancelled. After releasing the key the averaging process is starting again. This function is to be applied in order to minimize the drag error, if receiving very weak signals.

5.2.11 BID-Indicator

If the BeaconID is received, the indicator „BID“ is shown on the display. The BeaconID can be displayed in the submenu *INFO - BEACON*.

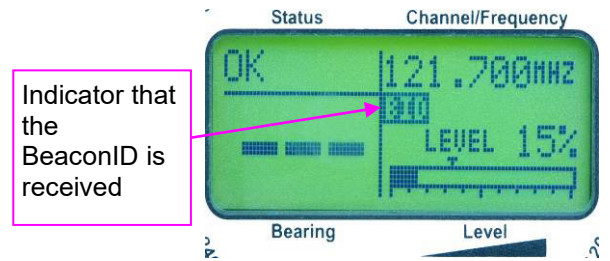

Fig. 26

6 The Menu

Adjustments and also system configurations, which have not to be changed during bearing operations, are to be selected and adjusted in the menu. Further information's as serial numbers or software versions are available.

ATTENTION

Wrong adjustments may affect the bearing system`s functions seriously. Alarm and bearing functions may not work as desired or may deliver faulty values if the system is wrong adjusted. It is important before starting to adjust, to know what to do. Therefore, please read this operating manual carefully in advance. In case of arising questions, please contact our service. We will support you gladly.

- Key 7 < Menu > calls up the main menu on the LC-display.
- Using keys 3 < ← >, 5 < ↑ >, 8 < → >, and 10 < ↓ > navigating in the corresponding submenu. The selected menu subjects are shown inverted (highlighted).
- Key 6 < Ok > will confirm the selection.
- Pressing key 9 < Esc > will reject the new selection and the device will return to the next higher menu level, or in the main menu, the device will leave the menu function.
- If the menu is called up and key 7 < Menu > is pressed, the device will return to the bearing mode. Changed adjustments will be rejected.

For better orientation the LC-display's top line is showing the present position in the menu.

6.1 The Menu Structure

	1. Level	2. Level	3. Level	4. Level	
Menu	Light	DIM LCD			
		DIM LEGEND			
		DIM CIRCLE			
		LCD CONTRAST			
	Bearing	Bearing Type			
		View Bearing Setup			
	Info	Beacon			
		Receiver			
		DCU			
		Statistics			
	Sounds	Beep Volume			
		Alarm Volume			
	Setup	Bearing	Average		
			Compensation		
			Mounting		
			Offset		
			Last time		
			Last Comp		
		Receiver	Channel Mode		
			Power On Default		
			AFC Mode		
		Serial	RX Type		
			Baud Rate		
			Identity		
			Protocol		
			Talk Mode		
			Talk Time		
		Compass	True Source		
	Static True				
	Intern Compass			Calibration	
Magnetic Source			Deviation		
	Static Mag.		Variation		
Other	Relay		Relays Mode		
	Ext. Input		MOB Pulse Time		
	Demo Mode				
	Factory Reset				
Service	Bearing				
	Receiver				
	DCU				
	Compass				
	Reboot				

- Menu Selection
- Selection
- Adjustment
- Display
- Routine

6.2 The Main Menu

6.2.1 Structure

Fig. 27

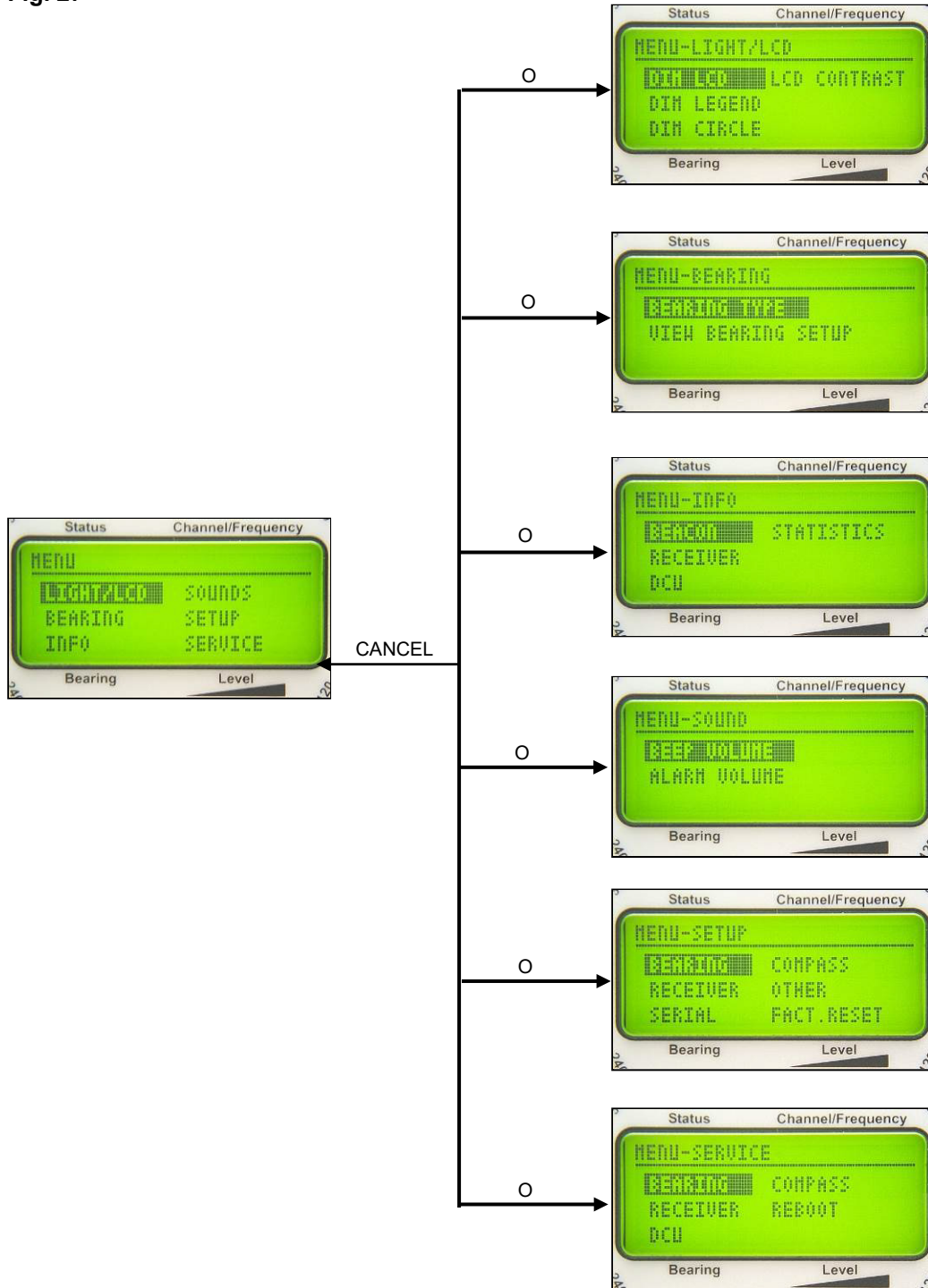

Pressing key 7 < Menu > in the bearing mode will call up the main menu. Following submenus may be selected:

- a) LIGHT/LCD: Adjustments of the LC-display's lighting, keyboard, LED-circle and the display's contrast
- b) BEARING: Selection of reference direction for the digital bearing value
Indication of relevant bearing parameters
- c) INFO: Indication of received transmitter identification
Indication of receiver-parameters
Indication of DCU-parameters
Indication of operating parameters
- d) SOUNDS: Adjustment of the keyboard's volume
Adjustment of the alarm signal's volume
- e) SETUP: Selection of bearing parameters
Receiver adjustments
Configuration of interface
Selection of bearing value compensation with compass
Other adjustments
Reset of factory defaults
- f) SERVICE: Displays and parameters required for service purposes

6.2.1.1 Menu LIGHT/LCD



In the submenu *LIGHT/LCD* all lighting adjustments for display, keyboard and contrast can be done.



Fig. 28

6.2.1.1.1 Adjusting Brightness of LC- Display: Function DIM LCD



In the submenu *LIGHT/LCD* select function *DIM LCD*. The bar graph as shown in Fig. 29 will appear. Keys 5 < + > and 10 < - > adjust background lighting of the LC- display.



Fig. 29

Keys 8 < → > respectively 3 < ← > will switch the brightness to maximum or will switch off the lighting.

Confirm adjustment using key 6 <Ok>.

6.2.1.1.2 Adjusting Brightness of Keyboard Lighting: Function DIM LEGEND



In the submenu *LIGHT/LCD* select function *DIM LEGEND*. The bar graph as shown in Fig. 30 will appear.

- Adjust brightness of the keyboard lighting using keys 5 < + > and 10 < - >.
- Keys 8 < → > respectively 3 < ← > will switch brightness to maximum or shut off.
- Confirm selected adjustment using key 6 < Ok >.
- Key 9 < Esc > will reject the adjustment, the device is returning to the next higher menu level. In the main menu this will finish the menu mode.



Fig. 30

6.2.1.1.3 Adjusting Brightness of LED-Circle: Function DIM CIRCLE



In the submenu *LIGHT/LCD* select function *DIM CIRCLE*. The bar graph as shown in Fig. 31 will appear.

- Adjust the brightness of LED-circle using keys 5 < + > and 10 < - >.
- Keys 8 < → > respectively 3 < ← >, will switch the brightness to maximum or shut off.
- Confirm selected adjustment using key 6 < Ok >.
- Key 9 < Esc > will reject the adjustment, the device is returning to the next higher menu level. In the main menu this will finish the menu mode.



Fig. 31

6.2.1.1.4 Adjusting Contrast of the LC-Display: Function LCD CONTRAST



In the submenu *LIGHT/LCD* select function *LCD CONTRAST*. The bar graph as shown in Fig. 32 will appear.

- Adjust contrast of LC-display using keys 5 < + > and 10 < - >.
- Keys 8 < → > respectively 3 < ← > will switch contrast to maximum or minimum.
- Confirm selected adjustment using key 6 < Ok >.
- Key 9 < Esc > will reject the adjustment, the device is returning to the next higher menu level. In the main menu this will finish the menu mode.



Fig. 32

NOTE

If adjusting the contrast to minimum respectively maximum value, the display may become unreadable! This may complicate readjustment or make it even impossible.

In case of wrong display contrast please proceed as follows:

- Switch off device using key 1 < On/Off >.
- Keep pressed key 7 < Menu > and
- Switch on device using key 1 < On/Off >.
- Release key 7 < Menu >.

The contrast adjustment has the default value. If desired, proceed with a new contrast adjustment.

6.2.1.2 Menu: BEARING

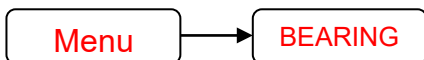

Fig. 33

In the submenu *BEARING* the reference direction of the bearing value display may be selected (see Fig. 7: Display). Furthermore, all relevant bearing setups can be observed.

6.2.1.2.1 Selecting Bearing Reference Direction: Selecting Function BEARING TYPE



Fig. 34

In the submenu *BEARING* select function *BEARING TYPE*. The submenu as shown in Fig. 34 will appear.

- Select reference direction by using keys 8 < → > respectively 3 < ← >. The selection is shown **inverted**.
- Confirm selection by using key 6 < Ok >.
- Key 9 < Esc > will reject the adjustment, the device is returning to the next higher menu level. In the main menu this will finish the menu mode.

6.2.1.2.1.1 Reference Direction: Relative Bearing - REL

The digitally indicated bearing value is relative to the antenna's longitudinal axis. If mounted correctly, it is corresponding to the vessel's (vehicle's) longitudinal axis.

NOTE

For the determination of the relative bearing no compass information (via NMEA interface or compass module) is required (see. 5.2.8). So, the relative bearing value is available if an external compass is out of order.

The digitally shown bearing value is corresponding to the indication of the LED-circle.
The reference direction is indicated as REL (=relative) left of the digital bearing value.

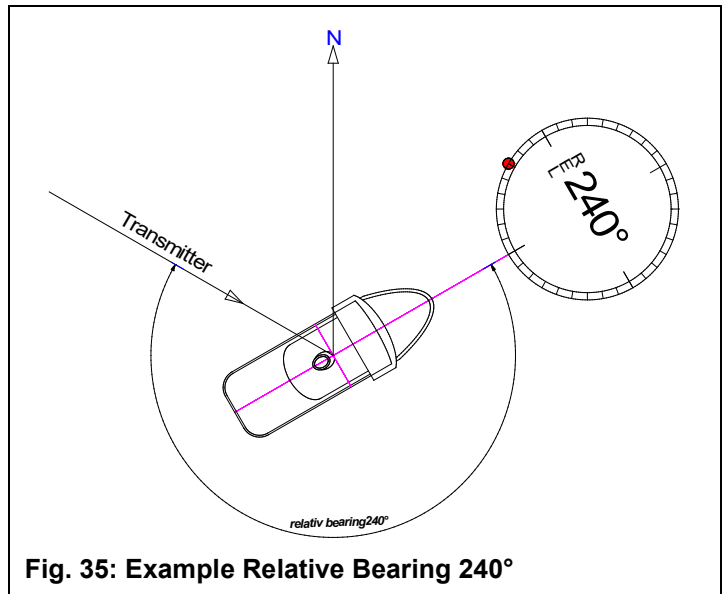

Fig. 35: Example Relative Bearing 240°

6.2.1.2.1.2 Reference Direction: (Magnetic) North - MAG

If compass data, basing on magnetic north, are available at the interface, and / or the internal compass (optional) is installed, bearing values with reference direction magnetic north may be put out.

In example of Fig. 37 bearing relations are shown for the bearing display of Fig. 36.

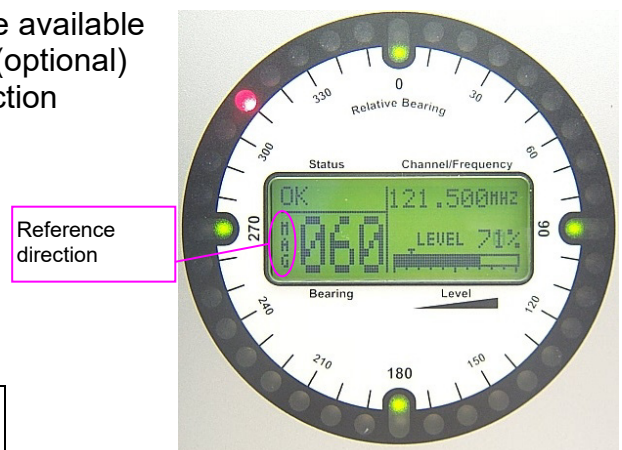

Fig. 36

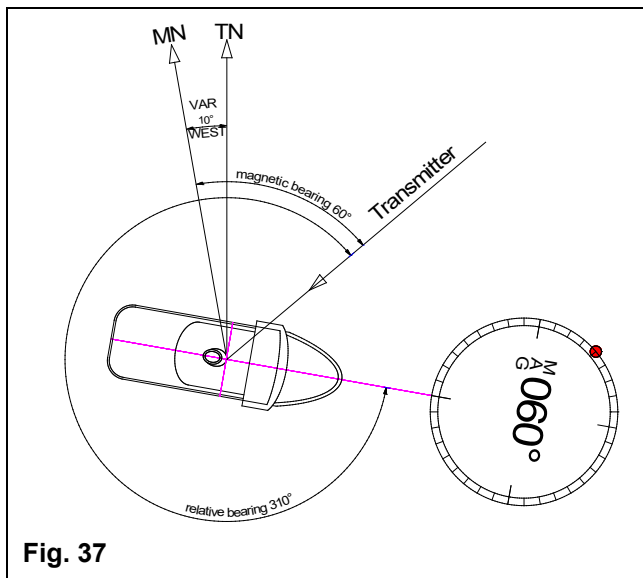

Fig. 37

6.2.1.2.1.3 Reference Direction: Geographic North (True North) - TRUE

If compass data, basing on true (geographic) north, are available at the interface, bearing values referring to true north can be put out. Choose in submenu *BEARING - TYPE* selection TRUE (= true north). Now the active reference direction is displayed as TRU (= true) left of the digital bearing value.

If the optional compass module is installed, the bearing value can also be put out with reference direction geographic north. For this the local variation has to be set up in in the setup-menu (see 6.2.1.5.4.5.3).

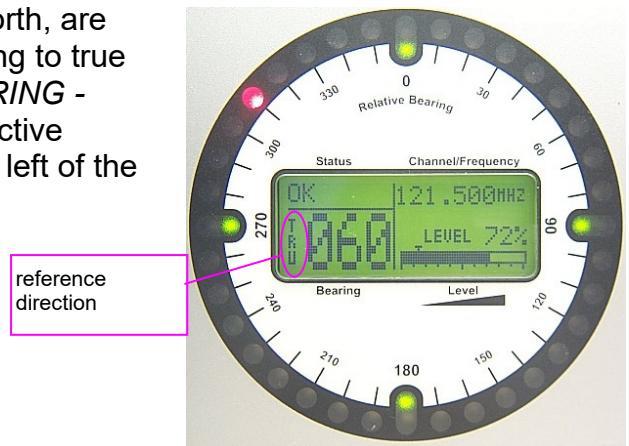

Fig. 38

The example of Fig. 39 is showing relations for the bearing display of Fig. 38.

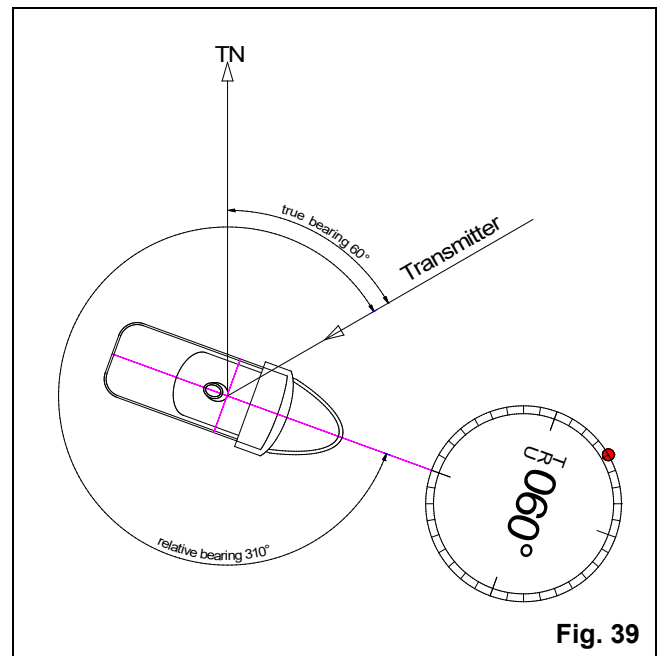

Fig. 39

6.2.1.2.2 Display Bearing Parameters: VIEW BEARING SETUP



In the submenu *BEARING* select display function *VIEW BEARING SETUP*, see Fig. 40.

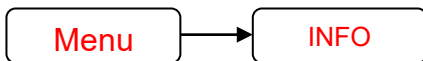

Fig. 40

The important bearing adjustments are shown here.

Designation	Meaning	Range	See chapter.
AVERAGING-LEVEL	Depth of averaging store	1 ... 9	6.2.1.5.1.1
COMPENSATION	drag error compensation by compass data	ON / OFF	6.2.1.5.1.2
MOUNTING	Antenna mounting normal = mast upright inverse = mast downright	normal, inverse	6.2.1.5.1.3
OFFSET	Offset value to be added to bearing value, e.g. in order to compensate mounting errors.	0 – 360°	6.2.1.5.1.4

6.2.1.3 Menu: INFO



Following information can be displayed in the submenu *INFO*:

- BEACON: Receiver identification
- RECEIVER: Receiver data
- DCU: Data of the Display Control Unit (DCU)
- STATISTICS: Operating data of the system



Fig. 41

6.2.1.3.1 INFO Beacon

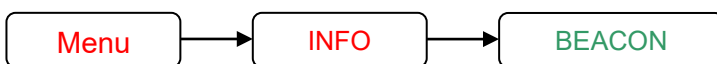

In the submenu *INFO* select display function *BEACON*. The display appears as shown in Fig. 42.

If the BeaconID is received, the BeaconID can be displayed in the submenu *INFO - BEACON*.

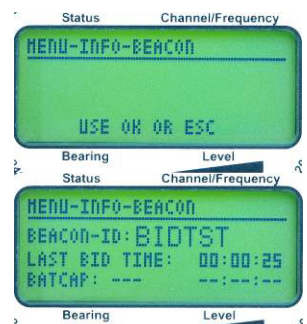

Fig. 42

6.2.1.3.2 INFO Receiver



In the submenu *INFO* select display function *RECEIVER*. The display appears as shown in Fig. 43.

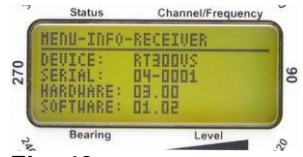

Fig. 43

Here the important data of the receiver can be seen:

Designation	Meaning
DEVICE	type of receiver
SERIAL	serial number of receiver
HARDWARE	hardware version of receiver
SOFTWARE	software version of receiver.

6.2.1.3.3 INFO DCU (Display Control Unit)



In submenu *INFO* select display function *DCU*. The display appears as shown in Fig. 44.

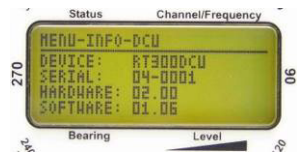

Fig. 44

Here the important data of the DCU can be seen:

Designation	Meaning
DEVICE	type of DCU
SERIAL	serial number of DCU
HARDWARE	hardware version of DCU
SOFTWARE	software version of DCU

6.2.1.3.4 INFO Statistics



In submenu *INFO* select display function *STATISTICS*. The display appears as shown in Fig. 45.

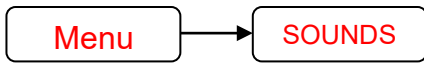

Fig. 45

Here the operating parameters can be seen:

Designation	Meaning
SWITCHED ON	number of switch-on's
RUNNING TIME	operating time
EBWJ RESETS	number of recognized resets

6.2.1.4 Menu: SOUNDS



In submenu *SOUNDS*, the volume of keyboard signals and of the alarm sound may be adjusted.



Fig. 46

6.2.1.4.1 Adjusting Key Volume: Function BEEP VOLUME



In this menu the volume of the short audible tone, if pressing a key, can be adjusted.



Fig. 47

In submenu *SOUND* select function *BEEP VOLUME*.

The bar graph as shown in Fig. 47 will appear.

- Using keys 5 < + > and 10 < - > the volume of the key signal can be adjusted.
- Keys 8 < → > respectively 3 < ← > will set the volume to maximum respectively minimum.
- Key 6 < Ok > is confirming the adjustment.

6.2.1.4.2 Adjusting Volume Alarm Signal: Function ALARM VOLUME



If a distress signal is detected, an alarm signal is put out at the speaker and at the audio exit. The volume is adjustable.



Fig. 48

In submenu *SOUND* select function *ALARM VOLUME*.

The bar graph appears as shown in Fig. 48.

- Using keys 5 < + > and 10 < - > the volume can be adjusted.
- Keys 8 < → > respectively 3 < ← > will maximize respectively minimize the volume.
- Key 6 < Ok > will confirm the adjustment.

ATTENTION

Too low alarm signals may be not recognized and search and rescue measures may start too late or not at all.

6.2.1.5 Menu: *SETUP*

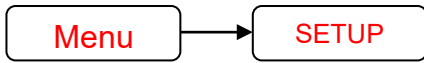

Fig. 49

In submenu *SETUP* all operating setups can be done. Prior putting into operation the bearing system, all setups have to be checked, and if required adapted.

ATTENTION
Faulty setups may lead to considerable misfunctions, which may not be recognized immediately. Therefore, the setup is to be lead only by instructed persons.

In order to avoid unauthorized changes of the setup, the setup menu can be locked. The locking is indicated by the symbol (see Fig. 50).
 For locking and unlocking see 6.3.1.



Fig. 50

Locked Setup Menu

The setup-menu is structured as follows:

Menu Designation	Meaning	see chapter
BEARING	Setups controlling bearing functions	6.2.1.5.1
RECEIVER	Setups controlling receiver functions	6.2.1.5.2
SERIAL	Setup of interface parameter	6.2.1.5.3
COMPASS	Setup of compass data	6.2.1.5.4
OTHER	Setup of alarm contact functions Setup external input	6.2.1.5.5
FACT. RESET	Routine to reproduce factory defaults	6.2.1.5.6

6.2.1.5.1 *SETUP-Menu BEARING*



Fig. 51

In submenu *BEARING* the setups for the bearing value determination are executed.

ATTENTION
Setup adjustments in this menu are influencing the bearing result. Faulty setups may lead to wrong bearing results, and it may not be possible, to recognize this error immediately. In case of doubt don't hesitate to contact the service or the service hotline of RHOTHETA.

Following setups can be done in the menu *BEARING*:

Menu Designation		Meaning
AVERAGING	Averaging bearing value	Adjustment of the depth of the bearing value memory
COMPENSATION	Compensation of reference direction	Selection of heading compensation source
MOUNTING	Mounting direction (up / down)	Input of mounting direction
OFFSET	Bearing value offset	Input of a correcting value (deviation) for bearing value output
LAST TIME	Duration of indication of last bearing value	Adjustment of bearing value indication after last bearing
LAST COMP	Correction of the heading in LED-circle display	Activation / Deactivation of heading compensation of LED-circle display (repeat function)

6.2.1.5.1.1 Adjusting Bearing Value Averaging Memory: AVERAGING

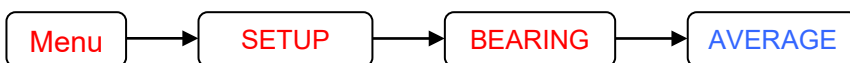

Fig. 52

Common Remarks:

The bearing system processes about 750 bearing values a second. Depending on the quality of the received signal (field strength, modulation), the single bearing results may be varying significantly. The single bearing values are being averaged with a special algorithm by the DCU's electronic. The depth of the value memory (number of used single bearing values) may be adjusted in submenu *SETUP - BEARING - AVERAGING* (see Fig. 52).

To be considered:

- the greater the averaging level → the greater the depth of memory
- the greater the averaging level → the more stable the display
- the greater the averaging level → the higher the sensitivity
- the greater the averaging level → the more drag error!

So, the adjustment has to be a compromise between a stable display and the drag error. With a high averaging level the sensitivity becomes a bit better (with deactivated squelch), but the display is getting rather inert, thus complicating the normal working with the system.

With a low averaging level the display becomes a kind of nervous, especially with modulated, weak signals.

The factory default has the averaging level 5 and is a good compromise.

Operating:

In submenu *BEARING* select function *AVERAGING*.

The bar graph as shown in Fig. 52 will appear.

- Adjust averaging level by using keys 5 < + > and 10 < ->.
- Keys 8 < → > respectively 3 < ← > will reset the level to maximum or minimum.
- Key 6 < Ok > will confirm the adjustment.

6.2.1.5.1.2 Select Source of Heading Compensation: SET COMPENSATION SOURCE

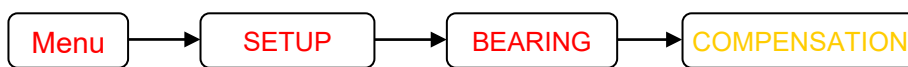

Fig. 53

During mobile use on vessels or land vehicles it takes a certain time for the display to respond to a change of heading (or course) (see → drag error, 6.2.1.5.1.1). If compass information is available, the change of heading will be determined and the drag error can be eliminated by the bearing system. The bearing system is corresponding without delay to the changes of heading of the vehicle.

In order to activate this function, the delivered (and required) compass data (true, magnetic, internal compass) for compensation have to be selected. It is only mentioned here, that the selected data sources have to be available (see 6.2.1.5.4).

NOTE

Drag errors will only be compensated, if caused by changes of the heading of the own vehicle. If the transmitter is changing its position, a drag error will occur again.

Following compass data sources may be selected:

Designation	Meaning	see chapter
OFF	No heading compensation	
TRUE	The source is an external compass with reference direction geographic (true) north	6.2.1.5.4.1
MAG	The source is an external compass with reference direction magnetic north	6.2.1.5.4.2
INT	The source is the internal compass module (optional)	6.2.1.5.4.5

6.2.1.5.1.3 Selecting Mounting Direction of Antenna: SELECT MOUNTING TYPE

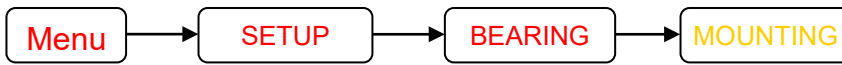

Fig. 54

Usually the antenna is mounted on top of a mast (see Fig. 55). In special cases it may be necessary to mount the antenna upside down (see Fig. 56).

In submenu *SETUP – BEARING - MOUNTING*, the mounting direction is selected.

NORM is corresponding to the normal top-mounting Fig. 55, *INVERS* corresponds to the upside down mounting as shown in Fig. 56.

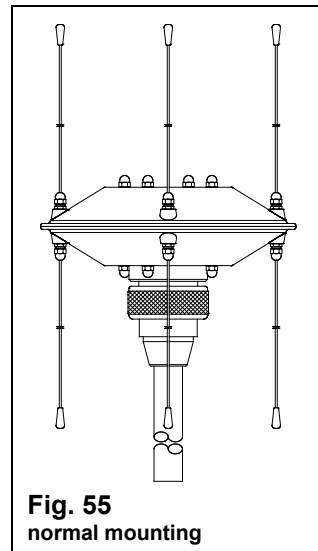

Fig. 55
normal mounting

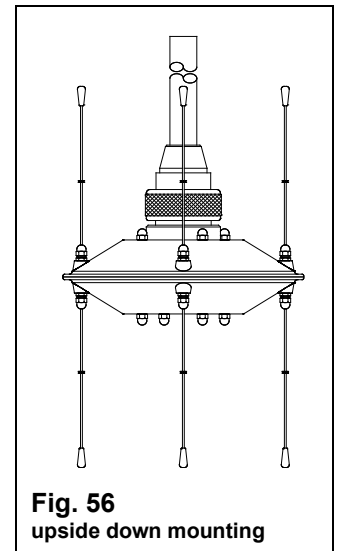
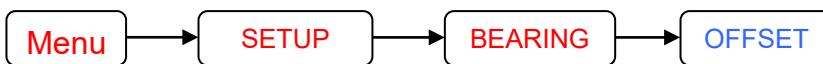

Fig. 56
upside down mounting

6.2.1.5.1.4 Adjusting Correcting (Offset) Value: ADJUST BEARING OFFSET



If bearing results are differing with a constant value from the actual angle of arrival, a correcting value (offset) can be adjusted, to be added to each bearing result. Deviations are caused e.g. by incorrect alignment of the antenna with the longitudinal axis of the vehicle.

Adjust offset in submenu *SETUP – BEARING – OFFSET*:

- Select the decimal with keys 3 < ← > and 8 < → > .The position is underlined.
- Keys 5 < + > and 10 < - > are increasing / decreasing the value.
- If decreasing the value to +000, the sign will change to negative. A negative sign indicates the value to be subtracted from the bearing result.
- Confirm the adjusted value with key 6 < Ok > . The device is returning to the next higher menu level.
- Key 9 < Clr > will reject the adjusted value. The device is returning to the next higher menu level and will work with the previous offset adjustment.



Fig. 57

6.2.1.5.1.5 Adj. Extended Display of Last Bearing Result: SET BEARING LAST TIME

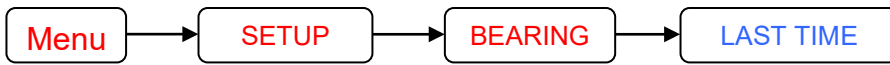

Fig. 58

After receiving the last signal, the bearing result is still displayed for a certain adjustable time. This adjustment is done in submenu *BEARING - LAST TIME*.

Operating:

- Using keys 3 < ← > and 8 < → > select the minutes or seconds to be changed. The selected digit is shown underlined.
- Increase or decrease the corresponding value by using keys 5 < + > and 10 < - >.
- Key 6 < Ok > will confirm the selected value. The device is returning to the next higher level in the menu.
- Key 9 < Esc > will reject the selected value. The device will return to the next higher level in the menu and will work with the previous adjustment.

6.2.1.5.1.6 Heading Compensation for REPEAT-FUNCTION: LAST VALUE COMPENSATION

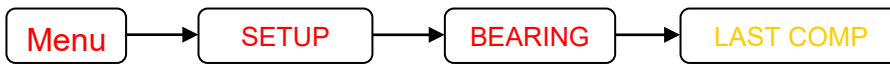

Fig. 59

The bearing result is always a relative bearing referring to the antenna’s longitudinal axis. If compass information’s are available, the bearing result can be converted to a direction, referring to north, independent of the antenna axis.

NOTE

The LED-circle will always indicate the relative bearing.

If now activating the *REPEAT*-function (showing the last bearing result – see 5.2.8), the displayed bearing value is the relative bearing value with the vehicles heading at the time when the last bearing signal was received. If there was a change of heading after the last bearing and after activating the *REPEAT*-function, the indicated bearing value has lost its meaning completely.

If compass data are available (external or internal), the change of heading can be measured. If activating now the *REPEAT*-function, the indicated value will be corrected for the present heading.

NOTE

There will only be compensated changes of heading of the own vehicle. Changes of bearing angles, caused by a change of position of the bearing or transmitting station will - of course - not be considered.

6.2.1.5.2 SETUP Menu RECEIVER



In setup menu *RECEIVER* all adjustments can be done concerning the bearing receiver and it's functions.



Fig. 60

Following adjustments can be done in submenu *RECEIVER*:

Menu short designation	Meaning	see chapter
CHANNEL MODE	Selecting frequency tuning (in the maritime band) by either selection of channel number or by input of frequency.	6.2.1.5.2.1
POWER ON DEFAULTS	Selection if system starts, when switching on, with last selected adjustments or with factory default.	6.2.1.5.2.2
AFC MODE	Activating / deactivating of AFC (automatic frequency control)	6.2.1.5.2.3

6.2.1.5.2.1 Frequency Selecting Mode in the Maritime Band: CHANNEL MODE



Usually the operating frequency in the maritime band is selected by an allocated channel number. The bearing system offers the possibility to input directly the frequency. In submenu *SETUP - RECEIVER - CHANNEL MODE* you can make this setup.



Fig. 61

CHANNEL MODE	Operating Order
ON	Frequency input by entering channel number
OFF	Direct frequency input

NOTE

Selection is **only** possible in the maritime band.

Operating:

- In submenu *SETUP - RECEIVER* select function *CHANNEL MODE*, see Fig. 61.
- With keys 5 < + > respectively 8 < → > and 10 < - > respectively 3 < ← > select ON or OFF.
- The active selection is shown inverted.
- Confirm selection with 6 < Ok >.
- Key 9 < Clr > will reject the selection. The device will return to the next higher level of the menu.

6.2.1.5.2.2 Selecting Starting Setup: POWER ON DEFAULT



Fig. 62

In submenu *SETUP - RECEIVER - DEFAULTS* it can be selected, if the previous frequency adjustments will be overtook or if channel 16 (156,800 MHz) will be preselected, after switching on the device.

In the airband the distress frequency is always preselected (121,500 MHz) in order not to miss an alarm.

LOAD POWER ON DEFAULTS	Starting setup
ON	Channel 16 (= 156,800 MHz) Airband: 121,500 MHz is preselected
OFF	In the maritime band, device will start with last operating frequency. Airband: 121,500 MHz

Operating:

- In submenu *SETUP - RECEIVER* select function *POWER ON DEFAULTS*, as shown in Fig. 62.
- Keys 5 < + > respectively 8 < → > and 10 < – > respectively 3 < ← > will select ON or OFF.
- The active selection is shown inverted.
- Key 6 < Ok > will confirm the selection.
- Key 9 < Clr > will reject the selection. The device will return to the next higher level of the menu, working with the previous adjustment.

6.2.1.5.2.3 Activating / Deactivating AFC: AFC MODE



Fig. 63

The bearing receiver is provided with an AFC circuitry (automatic frequency control). Thus, transmitters can be received, even if their frequency is a bit out of the permitted frequency range. The receiving frequency is tuned automatically in direction of the transmitter frequency.

In the setup menu *RECEIVER - AFC* the AFC-function can be activated and deactivated.

AFC MODE	Working order
ON	AFC activated
OFF	AFC deactivated

Operating:

- In submenu *SETUP - RECEIVER* select function *AFC MODE*.
- The menu appears as shown in Fig. 63.
- Keys 5 < + > respectively 8 < → > and 10 < – > respectively 3 < ← > will select ON or OFF.
- The active selection is shown inverted.
- Key 6 < Ok > will confirm selection.
- Key 9 < Clr > will reject the selection. The device will return to the next higher level of the menu, working with the previous adjustment.

6.2.1.5.3 SETUP Menu: SERIAL



In submenu *SETUP - SERIAL* all adjustments concerning interfaces and their function are done.

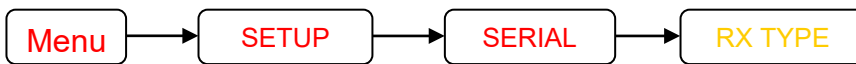

Fig. 64

Following adjustments can be done in submenu *SERIAL*:

Menu Short Designation	Meaning
RX TYPE	Selection of type of interface - RS-232 - RS-485 - RS-422 (NMEA)
BAUD RATE	Adjusting velocity of data transmission
IDENTITY	Selecting address-codes
PROTOCOL	Selecting data protocol
TALK MODE	Selecting transmitting mode
TALK TIME	Adjusting of transmitting repeating interval in <i>TALK MODE „Auto“</i>

6.2.1.5.3.1 Selecting Type of Serial Interface for Data Reception: SELECT SERIAL RX TYPE



For data exchange, the bearing system is offering three different interfaces:

- RS-232
- RS-485
- RS-422 (NMEA)

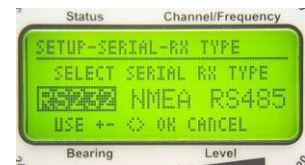

Fig. 65

In setup-menu *SERIAL - RX TYPE* the interface for data reception can be selected.

Designation	Meaning
RS232	Active interface RS-232
NMEA	Active interface RS-422 (NMEA)
RS485	Active interface RS-485

NOTE

See documentation “RT-300 NMEA Serial Communication & Remote Control” describing exactly all these functions.

6.2.1.5.3.2 Adjusting Velocity of Data Transmission: SET SERIAL BAUD RATE



Fig. 66

In submenu *SETUP – SERIAL - BAUD RATE*, the velocity of data transmission (Baud Rate) of the serial interface can be adjusted.

Following Baud rates are possible:

1.200; 2.400; 4.800; 9.600; 14.400; 19.200; 28.800; 38.400; 57.600; 76.800;115.200 Baud.

NOTE

See documentation “RT-300 NMEA Serial Communication & Remote Control” describing exactly all these functions.

6.2.1.5.3.3 Adjusting Device Addressing: SET SERIAL IDENTITY

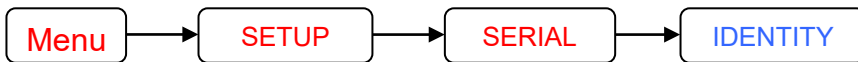

Fig. 67

In submenu *SETUP - SERIAL - IDENTITY* an address of the interface for the bearing system can be set.

NOTE

See documentation “RT-300 NMEA Serial Communication & Remote Control” describing exactly all these functions.

Operating:

In submenu *SETUP - SERIAL* select function *IDENTITY*.

- The menu appears as shown in Fig. 67.
- Keys 5 < + > respectively 8 < → > and 10 < – > respectively 3 < ← > will increase / decrease the address.
- Key 6 < Ok > will confirm selection.
- Key 9 < Clr > will reject the selection. The device will return to the next higher level of the menu, working with the previous adjustment.

6.2.1.5.3.4 Selecting Data Protocol: SELECT SER. TX PROTOCOL

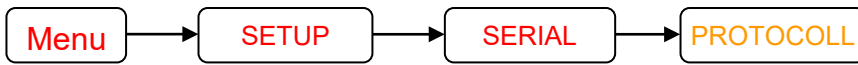

In submenu *SETUP – SERIAL - PROTOCOL* the data protocol of the serial interface can be adjusted.

Following adjustments are possible:

- NMEA
- Binary (at the present no data record defined)

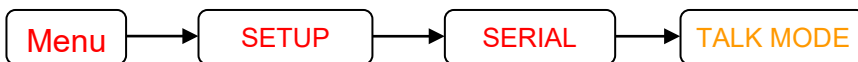

Fig. 68

NOTE

See documentation “RT-300 NMEA Serial Communication & Remote Control” describing exactly all these functions.

6.2.1.5.3.5 Selecting Type of Transmission: SELECT SER. TALK MODE



In submenu *SETUP - SERIAL - TALK MODE* the type of data transmission of the serial interface can be selected.

Following adjustments are possible:



Fig. 69

Designation	Meaning
REQUEST	Data will only be sent if required by an other device
AUTO	Data will be sent automatically in a certain adjustable interval

NOTE

See documentation “RT-300 NMEA Serial Communication & Remote Control” describing exactly all these functions.

6.2.1.5.3.6 Adjusting Transmitting Interval: SET SERIAL AUTO TALK TIME

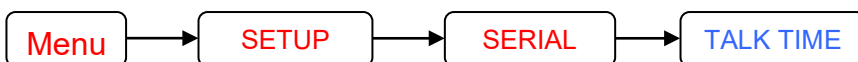

In submenu *SETUP - SERIAL - TALK TIME* select time interval for sending data via the serial interface in transmitting mode “auto”.



Fig. 70

NOTE

See documentation “RT-300 NMEA Serial Communication & Remote Control” describing exactly all these functions.

Operating:

- In submenu *SETUP - SERIAL* select adjusting function *TALK TIME*.
- The menu appears as shown in Fig. 70.
- Keys 5 < + > respectively 8 < → > and 10 < – > respectively 3 < ← > are increasing / decreasing the interval.
- Key 6 < Ok > will confirm the adjustment.
- Key 9 < Clr > will reject the selection. The device will return to the next higher level of the menu, working with the previous adjustment.

6.2.1.5.4 SETUP Menu: COMPASS



Fig. 71

Via it’s NMEA-interface the bearing system is able to receive and to process data of an external compass and data of the internal compass module. These data are used to put out heading information referring to north and to compensate drag errors caused by changes of heading.

In setup menu *COMPASS* the reference direction of the incoming data (magnetic / geographic) is to be defined.

NOTE

For stationary use instead of compass data, constant values can be put in (see 6.2.1.5.4.4).

Following adjustments in submenu *SETUP - COMPASS* can be done:

Menu Short Designation	Meaning	see chapter
TRUE SOURCE	Source for compass data referring to geographic north: - Static True - Internal compass (optional) - NMEA-data in format HCHDG - NMEA-data in format XXHDT - NMEA-data in format XXHDM	6.2.1.5.4.1
MAG SOURCE	Source for compass data referring to magnetic north: - Static magnetic - Internal compass (optional) - NMEA-data in format HCHDG - NMEA-data in format XXHDT - NMEA-data in format XXHDM	6.2.1.5.4.2
STATIC TRUE	Input of a constant angle as reference to geographic north. → function required for stationary use	6.2.1.5.4.3
STATIC MAG	Input of a constant angle as reference to geographic north. → function required for stationary use	6.2.1.5.4.4
INT. COMPASS		6.2.1.5.4.5

Operating:

- In setup-menu select function *COMPASS*.
- The display will appear as shown in Fig. 71.
- With keys 5 < ↑ > respectively 10 < ↓ > and 3 < ← > respectively 8 < → > select corresponding data source.
- The active selection is shown inverted.
- Key 6 < Ok > will confirm the adjustment.
- Key 9 < Clr > will reject the selection. The device will return to the next higher level of the menu, working with the previous adjustment.

6.2.1.5.4.1 Selecting Data Source Referring to Geographic (True) North: SET COMPASS TRUE SOURCE

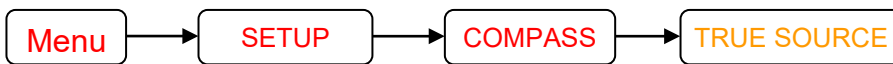

In submenu *SETUP – COMPASS - TRUE SOURCE* a data source is assigned to true north.



Fig. 72

Following adjustments are possible:

Designation	Meaning
STATIC TRUE	A constant value is used as source. This value can be adjusted as mentioned also in 6.2.1.5.4.3. This adjustment is required for stationary use.
INT.COMPASS	The source is the (optional) internal compass. NOTE The internal compass module is delivering data referring to magnetic north. Therefore, the local variation has to be compensated (see 6.2.1.5.4.5.3).
NMEA HCHDG	The data source is data of an external compass, connected via NMEA-interface. Data format is HCHDG (see documentation “RT-300 NMEA Serial Communication & Remote Control“, describing exactly all these functions).
NMEA XXHDT	The data source is data of an external compass, connected via a NMEA interface. Data format is XXHDT (see documentation ” RT-300 NMEA Serial Communication & Remote Control“, describing exactly all these functions).
NMEA XXHDM	The data source is data of an external compass, connected via a NMEA interface. Data format is XXHDM (see documentation “RT-300 NMEA Serial Communication & Remote Control“, describing exactly all these functions).

Operating:

- In submenu *COMPASS* select function *TRUE SOURCE*.
- The display appears as shown in Fig. 72.
- Keys 5 < ↑ > respectively 10 < ↓ > and 3 < ← > respectively 8 < → > are selecting the corresponding data source.
- The active selection is shown inverted.
- Key 6 < Ok > will confirm the adjustment.
- Key 9 < Clr > will reject the selection. The device will return to the next higher level of the menu, working with the previous adjustment.

6.2.1.5.4.2 Selecting Data Source Referring to Magnetic North: SET COMPASS MAG SOURCE

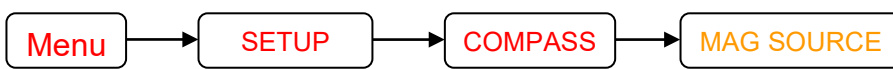

In submenu *SETUP - COMPASS - MAGN SOURCE* a data source is related to magnetic north.



Fig. 73

Following adjustments are possible:

Designation	Meaning
STATIC MAG	The source is a constant value. The value can be adjusted as described in. 6.2.1.5.4.4. This adjustment is required for stationary use.
INT COMPASS	The source is the (optional) internal compass.
NMEA HCHDGT	Data source are data of an external compass, connected via NMEA-interface. Data format is HCHDGT (see documentation "Serial Communication & Remote Control", describing exactly all these functions).
NMEA XXHDT	Data source are data of an external compass, connected via a NMEA interface. Data format is XXHDT (see documentation "Serial Communication & Remote Control", describing exactly all these functions).
NMEA XXHDM	Data source are data of an external compass, connected via a NMEA interface. Data format is XXHDM (see documentation "Serial Communication & Remote Control", describing exactly all these functions).

Operating:

- In submenu *COMPASS* select function *MAG SOURCE*.
- The display appears as shown in Fig. 73.
- Keys 5 < ↑ > respectively 10 < ↓ > and 3 < ← > respectively 8 < → > are selecting the corresponding data source.
- The active selection is shown inverted.
- Key 6 < Ok > will confirm the adjustment.
- Key 9 < Clr > will reject the selection. The device will return to the next higher level of the menu, working with the previous adjustment.

6.2.1.5.4.3 Input of Static True Value: SET STATIC TRUE HEADING

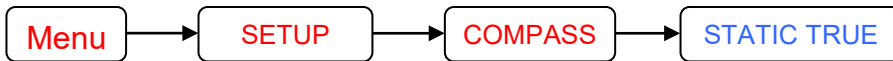

In submenu *SETUP – COMPASS - STATIC TRUE* a constant value (angle) can be related to the direction of reference *STATIC TRUE* (fixed, static mounting, referring to true north).

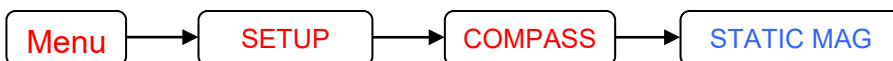

Fig. 74

Operating:

- Keys 3 < ← > and 8 < → > are selecting the decimal. The selected digit is shown underlined.
- Increase / decrease the corresponding value by using keys 5 < + > and 10 < - >.
- Key 6 < Ok > will confirm the selected value. The device will return to the next higher level.
- Key 9 < Esc > will reject the selected value. The device will return to the next higher level and is working with the previous offset adjustment.

6.2.1.5.4.4 Input of Value "Static magnetic": SET STATIC MAG



In submenu *SETUP - COMPASS - STATIC MAGN* a constant value (angle) can be related to the direction of reference *STATIC MAGNETIC* (fixed, static mounting, referring to magnetic north).

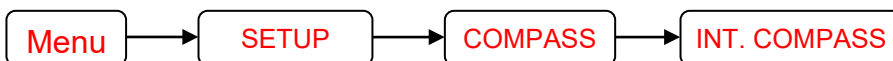

Fig. 75

Operating:

- Keys 3 < ← > and 8 < → > are selecting the decimal. The selected digit is shown underlined.
- Increase / decrease the corresponding value by using keys 5 < + > and 10 < - >.
- Key 6 < Ok > will confirm the selected value. The device will return to the next higher level.
- Key 9 < Esc > will reject the selected value. The device will return to the next higher level and is working with the previous offset adjustment.

6.2.1.5.4.5 Configuration of Internal Compass Module: INT. COMPASS



Is the bearing system equipped with the optional compass module, following adjustments have to be done:

- Calibrating the compass
- Compensating of deviation (compass error)
- Adjusting of local magnetic variation



Fig. 76

These adjustments can be done in submenu *SETUP – COMPASS - INT. COMPASS*.

6.2.1.5.4.5.1 Calibrating Compass: INT. COMPASS CALIBRATION



After installing the bearing antenna, the compass should be calibrated. Calibration eliminates environmentally caused interferences of the magnetic field. Calibration improves significantly the precision of the compass.

In order to calibrate the compass, the bearing antenna has to be rotated twice in its vertical axis, the rotational direction doesn't matter.

Procedure:

- In submenu *SETUP – COMPASS – COMPASS-INT - CALIBRATION* the display appears as shown in Fig. 77.
- Use key 8 < → > to start the calibrating procedure.
- Now the bearing antenna has to be rotated twice (720°) in its vertical axis with an angular speed as constant as possible.
- Exactly after rotating 720° the calibration process will be completed by pressing key 8 < → >.



Fig. 77



Fig. 78

Procedure for vessels:

- The vessel navigates with constant speed on a circular track as narrow as possible.
- Start the calibrating procedure at a certain compass course as described above.
- The display is as shown in Fig. 78.
- After ending the second circle (the same course shown in the compass display) the calibrating will be completed by pressing key 8 < → >.

Procedure for land vehicles:

- The vehicle is driving with constant speed on a circular track as narrow as possible (e.g. in a roundabout).
- Start the calibrating in a certain position as described above.
- The display is as shown in Fig. 78.
- After ending the second circle the calibrating will be completed by pressing key 8 < → >.

ATTENTION

After calibrating optimally, the precision of the compass is $\pm 2^\circ$. If the internal compass is used as a source for north referring bearings, in the adverse case, the compass error can be added the bearing result.

NOTE

The present compass data can be displayed in submenu *SERVICE - COMPASS* (see 6.2.1.6.4).

6.2.1.5.4.5.2 Input of Compass Error – Deviation: INT. COMPASS DEVIATION



Deviation is the difference of angle between the actual magnetic north direction and the north direction determined by the internal compass. Usually, the deviation may differ for each compass value. If the calibration was done properly, these differences have been eliminated largely. If a constant aberration is appearing, it can be compensated by the input of a correcting value.



Fig. 79

Example:

- The magnetic heading (MH) of the vessel is 118° (indicated on the vessel's compass).
- The compass heading (CH), put out by the compass module of the bearing system, is 125°.
- The difference between CH and MH is equal 7° that means a deviation of 7°.
- For the compass heading is greater than the magnetic heading, the direction of the deviation is "WEST" (the deviation is "EAST" if the compass heading is smaller than the direction of the deviation).
- The value to be put in in our example therefore is „WEST 007“.

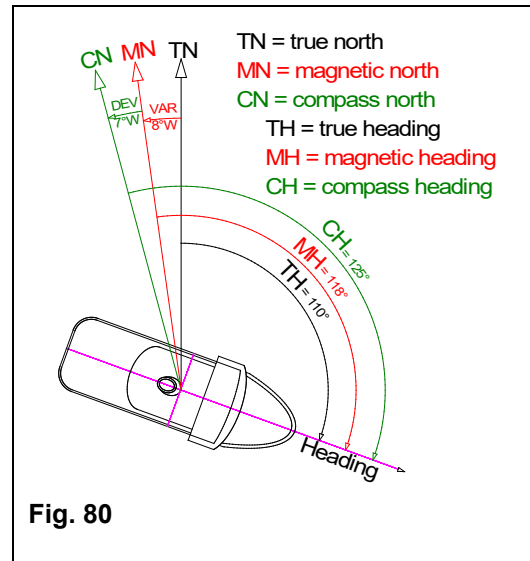

Fig. 80

NOTE

The present compass data can be displayed in submenu *SERVICE - COMPASS* (see 6.2.1.6.4).

6.2.1.5.4.5.3 Input Magnetic Variation: INT. COMPASS VARIATION



If the compass module shall be used as a source for geographic north, the local magnetic variation has to be put in.

Variation is the difference between geographic and magnetic north (see Fig. 80). Magnetic variation is depending on the location on earth and to be taken from corresponding charts.

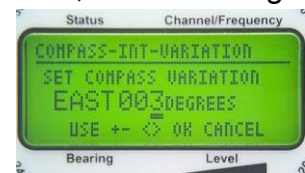

Fig. 81

6.2.1.5.5 SETUP Menu: OTHER



In submenu *OTHER* setups, concerning the operation of the relay contact of the alarm function, are done. Additionally the input of the self-bearing suppression (SBS) can be activated and the demo mode can be started.

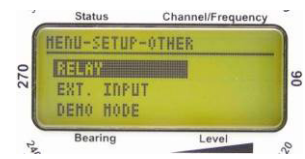
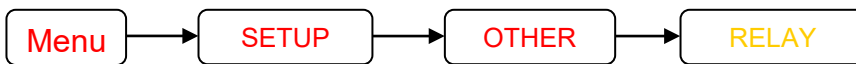

Fig. 82

6.2.1.5.5.1 Configuration of Relay-contact: RELAY



The bearing system RT-300 is equipped with a relay-contact, which is closing if a distress signal is detected. It's contacts are integrated in the „POWER“ connector (see 6.4.2.3), external devices may be connected (e.g. GPS MOB-function, alarm bell, warning light, etc.). The working order can be set up in submenu *SETUP - OTHER - RELAY*.



Fig. 83

6.2.1.5.5.1.1 Setting up Relay Mode: RELAYS MODE



Fig. 84

Depending on application, different relay modes can be selected:

Designation	Function	Application
DISABLED	Relay deactivated	no external device connected
ON	The contact remains closed until the received signal is disappeared.	Connection of an alarm bell

Designation	Function	Application
PULS	<p>As soon as a signal is exceeding the squelch level, the contact is closing for a defined time and will opens then again.</p> <p>A new activation of the relay will happen only after a restart of the system.</p> <p>The activation is indicated by the anchor-symbol in the LC-display (see Fig. 7: "status of alarm-contact").</p>	<p>For the connection of a MOB-function (Man Over Board) of a GPS-receiver → Storage of position at the time of reception. This function is working on all frequencies.</p> <div style="border: 1px solid black; padding: 5px; margin-top: 10px;"> <p>ATTENTION Releasing the relay by restarting the system is to avoid the following situation: If the transmitting signal is lost for a short time, the GPS-position would be overwritten. This position wouldn't be equivalent to the position of the first alarm (place of accident at MOB-situation). The first position would be overwritten (depending on GPS) and therefore lost.</p> </div>
ELT-ON	<p>Contact closes, as soon as a distress signal (ELT-modulation) is recognized by the "selective squelch" and will open again, if no more signal is received.</p> <p>This function is only available in the airband.</p>	<p>Connection of an alarm bell (if a distress signal is received) to be activated only in the airband.</p> <p>Recommended in connection with Only-ELT-function.</p>
ELT-PULS (MOB)	<p>Contact closes, as soon as the "selective squelch" has recognized a distress signal (ELT-modulation) for a defined time and will opens then again.</p> <p>A new activation of the relay will happen only after restarting the system.</p> <p>The activation is indicated by the anchor symbol in the LC-display (see Fig. 7: "alarm contact status").</p>	<p>As at PULS function, but the system will react only on signals in the airband.</p>

6.2.1.5.5.1.2 Adjusting Pulse Duration of the Relay: MOB PULSE TIME



In submenu *SETUP – OTHER – RELAY – MOB PULSE TIME* the pulse duration of the relay contact can be adjusted. The adjustment can be made for the relay modes „PULS“ and „ELT-PULS (MOB)“.

Select pulse duration between 100 ms and 2500 ms.



Fig. 85

6.2.1.5.5.2 Activating / Deactivating of Self Bearing Suppression: EXT. INPUT

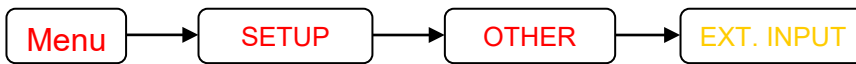

If there shall be transmitted on the receiving frequency of the vehicle / ship, also the own transmitting signal will be beared and the system shows the direction of its own antenna. Usually this is not desired, additionally there is the disadvantage, that the last bearing will be overwritten.

In order to avoid this, there is the function “self-bearing suppression” (SBS).

For the SBS-function the PTT-key of the transmitter has to be connected to PIN 8 of the “power” connector (see 6.4.2 and 10.1).

Now, if the key is actuated, the bearing process is interrupted. The own receiver is not recorded.



Fig. 86

6.2.1.5.5.3 Activating / Deactivating of DEMO-Mode: DEMO MODE

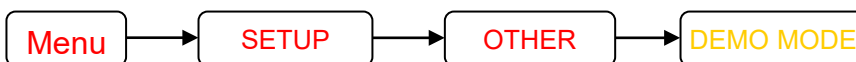

By activating the *DEMO MODE* the DCU can be used without a connected antenna unit (AU). This is very useful for training or maintenance.

The DCU emulate the AU and shows a fictive bearing which is slowly moving all the time.



Fig. 87

6.2.1.5.6 SETUP Menu: FACTORY RESET

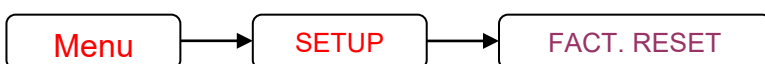

In submenu *SETUP* the function *FACT. RESET* can be selected. This function will reset following adjustments to the factory default:



Fig. 88

Designation	Short Designation	Factory default	See chapter
Brightness of LC-display	DIM LCD	100 %	6.2.1.1.1
Brightness of keyboard	DIM LEGEND	50 %	6.2.1.1.2
Brightness LED-circle	DIM CIRCLE	100 %	6.2.1.1.33
Contrast of LC-display	LCD CONTRAST	45 %	6.2.1.1.44
Bearing reference direction	BEARING TYPE	REL	6.2.1.2.1
Volume audio-signal	VOL +; VOL -	50 %	5.2.5
Volume keyboard -signal	BEEP VOLUME	50 %	6.2.1.4.1
Volume alarm-signal	ALARM VOLUME	100 %	6.2.1.4.2
Bearing value averaging memory	AVERAGING	Level 5	6.2.1.5.1.1
Source heading-compensation	COMPENSATION	OFF	6.2.1.5.1.2
Mounting direction of bearing antenna	MOUNTING	NORM	6.2.1.5.1.3
Correction value offset	BEARING OFFSET	0°	6.2.1.5.1.4
Extended display of bearing value	LAST BEARING TIME	10 sec	6.2.1.5.1.5
Heading compensation for REPEAT function	LAST VALUE COMPENSATION	OFF	6.2.1.5.1.6
Frequency selecting mode	CHANNEL MODE	ON	6.2.1.5.2.1
Starting setup	POWER ON DEFAULT	ON	6.2.1.5.2.2
AFC (automatic frequency control)	AFC MODE	ON	6.2.1.5.2.3
Serial interface	RX-Type	RS-232	6.2.1.5.3.1
Data transmitting velocity (Baud rate)	SERIAL BAUD RATE	4800 Baud	6.2.1.5.3.2
Device addressing	SERIAL IDENTITY	000	6.2.1.5.3.3
Selecting data protocol	SER. TX ROTOCOL	NMEA	6.2.1.5.3.4
Selecting type of transmitting	SER. TALK MODE	AUTO	6.2.1.5.3.5
Transmitting interval	SERIAL AUTO TALK TIME	250 ms	6.2.1.5.3.6
Data source for reference direction geographic north	COMPASS TRUE SOURCE	NMEA XXHDT	6.2.1.5.4.1
Data source for reference direction magnetic north	COMPASS MAGN. SOURCE	NMEA XXHDT	6.2.1.5.4.2
Static True value	STATIC TRUE HEADING	0°	6.2.1.5.4.3
Static Magnetic value	STATIC MAG HEADING	0°	6.2.1.5.4.4
Deviation (internal Compass)	INT. COMPASS DEVIATION	0°	6.2.1.5.4.5.2
Variation (internal Compass)	INT. COMPASS VARIATION	0°	6.2.1.5.4.5.3
Relay-mode	RELAY MODE	DISABLED	6.2.1.5.5.1.1
Pulse duration of relay:	MOB PULSE TIME	10 ms	6.2.1.5.5.1.2
Self-bearing suppression (SBS)	EXT. INPUT	OFF	6.2.1.5.5.2

6.2.1.6 MENU: SERVICE

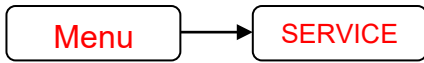

Fig. 89

In submenu *SERVICE* all functions required for the verification of the nominal characteristics of the bearing system, or to support the detection of errors, can be found.

6.2.1.6.1 Service Menu: BEARING

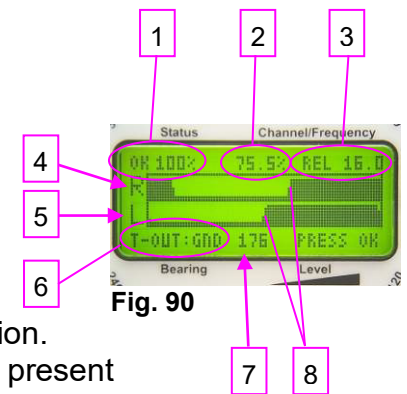

Fig. 90

In service menu *BEARING* all important data required for the determination of bearing values, are indicated. These data are used for error analysis in case of service as well as for preadjusting the signal-delay-time-compensation during production. While bearing, the bar graph is permitting conclusions about the present quality of bearing and signal.

Following data are displayed (see Fig. 90):

1. Bearing quality: percent of determined, usable single bearing values
2. Level: present signal field strength
3. Bearing value: reference direction and bearing value
4. Bearing phase clockwise rotation: averaged bearing values at clockwise rotation of antenna
5. Bearing phase anticlockwise rotation: averaged bearing values at anticlockwise rotation of antenna
6. Level testing signal
7. Value of signal-delay-time-adjustment
8. The slope of the bar is a measure of the bearing quality. The steeper the better is the bearing.

Operating:

- Key 9 < Clr > is cancelling the averaging memory. After releasing the key the bar graph will be rebuilt.
- Leave the menu by pressing key 6 < Ok >.

6.2.1.6.2 Service Menu: RECEIVER



Fig. 91

In submenu *SERVICE - RECEIVER* present receiver parameters are displayed:

Designation	Meaning
STATUS	Status of receiver module If no error detected, message OK is displayed. If error detected, the error number is displayed.
U-IN	Voltage supply of receiver module
U-OFFS	Offset voltage of the discriminator (Measure for frequency deviation of transmitter)
U-LEV	AGC voltage (measure for receiving field strength)
LEVEL	Receiving field strength (see also 0)
AFC	AFC activated or deactivated (see 6.2.1.5.2.3)

6.2.1.6.3 Service Menu: DCU



Fig. 92

In submenu *SERVICE - DCU* present DCU-parameters will be displayed:

Designation	Meaning
STATUS	Status of DCU If no error detected, message OK is displayed. If error detected, the error number is displayed.
U-IN	Voltage supply of DCU
EXT-IN	Displays present logic level of input EXT-IN (see 6.2.1.5.5.2)
AF-IN	Audio frequency counter (required for detecting an emergency signal)

6.2.1.6.4 Service Menu: COMPASS



In submenu *SERVICE - COMPASS* the compass data, available for the different reference directions respectively the internal (optional) compass module, are displayed.

Select the reference direction using key 3 < ← > and 8 < → >.

If there are available NMEA-data as shown in Fig. 93 the graphic display will show bearing value and data transmitting velocity. The LED-circle will show the present bearing too.

Example Fig. 93:

1. Data transmitting velocity (every 1000 ms one set of data); OK is indicating, that all data can be interpreted.
2. Present heading



Fig. 93

Example Fig. 94:

Internal compass
 Compass heading = 208°
 Data transmitting velocity: 250 ms
 Heading compensation: activated (+COMP)



Fig. 94

Example Fig. 95:

No compass data available for reference direction geographic north or too few data to be interpreted.

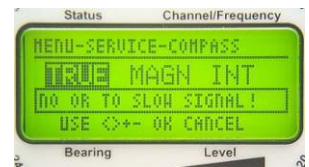

Fig. 95

6.2.1.6.5 Service Menu: REBOOT



Confirming *REBOOT* using key 6 < Ok > in submenu *SERVICE - REBOOT* will restart the microprocessor of the DCU.

During booting the display is showing „Please wait, reboot in progress!” as in Fig. 96.



Fig. 96

6.3 Special Functions

6.3.1 Locking / Unlocking the Setup Menu

The setup menu can be locked in order to prevent unauthorized change of the setup or by mistake. Select *SETUP* in the main menu and keep pressing key 12 < Scan > for about 3 sec, until the symbol  (padlock) is appearing (see Fig. 50). The setup menu is locked.

In order to unlock the menu, select *SETUP* in the main menu keep pressed key 12 < Scan > for 3 sec, until the symbol  disappears. The setup menu is unlocked.

6.3.2 Resetting Brightness and Contrast Adjustment of Display

Reading of the LC-display and correction of the contrast value may become impossible if adjusting the contrast value incorrectly.

In that case brightness and contrast adjustments can be reset as follows:

- Switch off DCU using key 1 < On/Off >
- Switch on DCU using key 1 < On/Off > **and**
- Press key 7 < Menu > within 1 sec after pressing key < On/Off >

Contrast of display and background lighting are set to the factory default. This adjustment will not be stored after switching off the DCU. Therefore, all adjustments in submenu *LIGHT/LCD* (see 6.2.1.1) have to be redone and confirmed with key < Ok >.

6.3.3 Loading Firmware Updates

If there is a new firmware available, it can be uploaded via the interface port on the backside of the DCU. How to proceed is described in the documentation “RT-300 Firmware Update” which is available by contacting RHOTHETA (www.rhotheta.de).

6.4 Interfaces

On the backside of the DCU three connectors can be found, connecting antenna, power supply and other external devices.

6.4.1 Antenna Connector on DCU

The antenna connector is connecting Display-Control-Unit (DCU) and (Fig. 2 ) Antenna Unit (AU).

Type of connector: D-Sub-socket; 9-poled

Pin wiring:

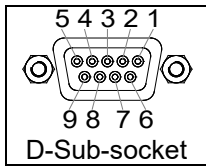

Contact (PIN)	Signal Name	Signal
1	ANT-EAST	control signal east
2	ANT-WEST	control signal west
3	RS485/A	data signal
4	RS485/B	data signal
5	12..28V	voltage supply
6	ANT-SOUTH	control signal south
7	ANT-NORTH	control signal north
8	NF	audio signal
9	PHI	bearing signal
Shield	GND	ground

6.4.2 Power Connector

The power supply is connected to the *Power Connector* (Fig. 2 ⑤). Additionally this connector contains contacts for the external speaker, alarm relay and input for the SBS-function (self-bearing suppression).

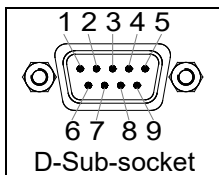

Contact (PIN)	Signal Name	Signal
1	GND	internal and housing ground,
2	NF-OUT-B	audio exit for external speaker
3	RELAY-B	alarm contact
4	RELAY-A	alarm contact
5	U-IN-GND	negative voltage supply
6	ANALOG-TEST	not connected
7	NF-OUT-A	audio exit for external speaker
8	EXT-INPUT	input for SBS-function
9	U IN 12..28V	positive voltage supply (12 ..28 V)
Shield	GND	housing ground, frame

6.4.2.1 Power Supply

The power supply is connected to
 PIN 5: [-] voltage supply GND (ground) and
 PIN 9: [+] positive voltage supply

Permitted range of operating voltage: 11V... 28 V DC

Current consumption: max. 800 mA (depending on operating voltage and connected external devices)

ATTENTION

- Ground of voltage supply not identical to ground of housing (due to interconnected noise filter)!
- Reversing polarity of the poles will damage the device!
- The voltage supply is not separated galvanically from the frame. If desired, e.g. in order to prevent current flow to the ground of the vessel, a DC/DC-converter has to be adapted.

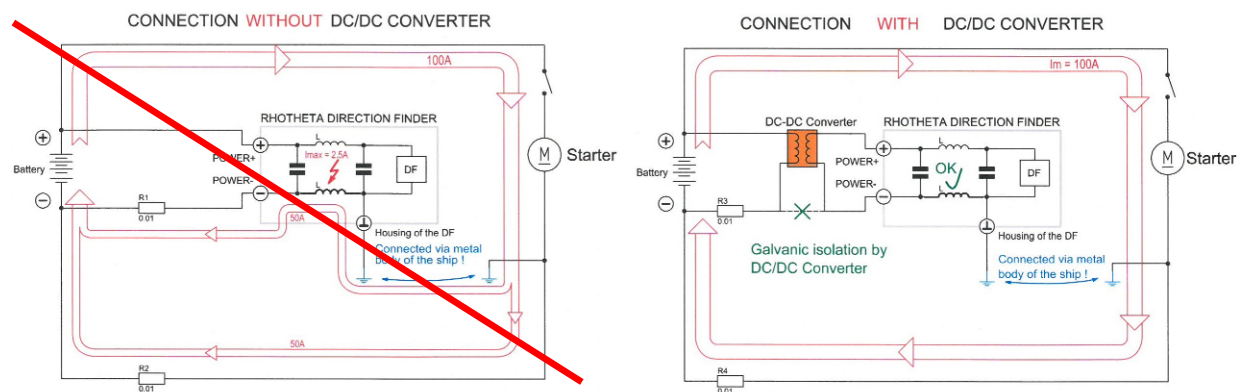

Fig. 97

6.4.2.2 External Speaker

An external speaker can be connected to the symmetric audio exit PIN 7 and PIN 2. The level of the audio signal is controlled in the “adjust volume” submenu (see 5.2.5.).

Permitted impedance of speaker: 4 ... 600 Ohm

Max. voltage (PIN 7 – PIN 2): 10 V_{SS}

Max. permitted power: 1,5 W

ATTENTION

The audio exit is connected to a push-pull amplifier. Therefore none of the audio signals is to be connected to ground. Grounding audio signals will damage the device.

6.4.2.3 Alarm Contact

The alarm contact is connected to (see 6.2.1.5.5.1) PIN 3 and 4. It is a mechanic relay with floating contacts.

Current: max. 1A

Max. voltage: 50 V (DC)

(values for ohmic (resistive) load)

Controlling: see 6.2.1.5.5.1

6.4.2.4 Extern Input

Contact PIN 8 is a sensory input for digital logic levels. The contact is connected to +5V by means of a PULL-UP-resistor (10 kΩ). In order to activate the SBS-function (as described in 6.2.1.5.5.2) the input has to be connected to GND (PIN 1) by the means of an external operating contact.

6.4.2.5 Analog Test

PIN 6 is carrying a test signal, serving for trouble-shooting in the case of service. During operation of the bearing system this contact is not to be connected.

6.4.3 Interface Connector

The bearing system RT-300 has different interfaces for data exchange.

- RS-232

- RS-422

- RS-485

These interfaces are connected to socket "Interface Connector" (see Fig. 2 ④).

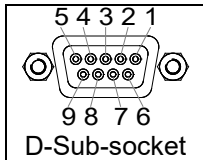

Contact (PIN)	Signal name	Signal
1	RS485TRX/RS422TX-B	Depending on adjustment, see 6.2.1.5.3.1 Selection: RS485 ⇔ RS-485 TRX-line NMEA ⇔ RS-422 TX-B-line RS232 ⇔ RS-232 TX-B-line
2	RS232TX	TX-line RS-232-interface (always active)
3	RS232RX	RX-line RS-232-interface (activating see 6.2.1.5.3.1)
4	RS422RX-SHIELD	RS-422 receiving line GND
5	GND	Ground
6	RS485TRX/RS422TX-A	Depending on adjustment see 6.2.1.5.3.1 Selection: RS485 ⇔ RS-485 TRX-line NMEA ⇔ RS-422 TX-B-line RS232 ⇔ RS-232 TX-B-line
7	RS422RX-A	RS-422 receiving line anode activation see 6.2.1.5.3.1
8	RS422RX-B	RS-422 receiving line cathode activation see 6.2.1.5.3.1
9	+5V-OUT	Voltage supply +5V DC (voltage supply for interface modules) Current output: max. 200 mA
Shield	GND	Ground

6.4.3.1 RS-232-Interface

For interface functions see documentation “RT-300 NMEA Serial Communication & Remote Control”

6.4.3.2 RS-485-Interface

For interface functions see documentation “RT-300 NMEA Serial Communication & Remote Control”

6.4.3.3 NMEA (RS-422) Interface

For interface functions see documentation “RT-300 NMEA Serial Communication & Remote Control”

7 Installation and Putting into Operation

7.1 Installation of Display-Control-Unit DCU

7.1.1 DCU Installing Cut-Out

The DCU is to be installed in an instrument panel in a suitable position. Therefore, an installing cut-out, as shown in Fig. 98, has to be set.

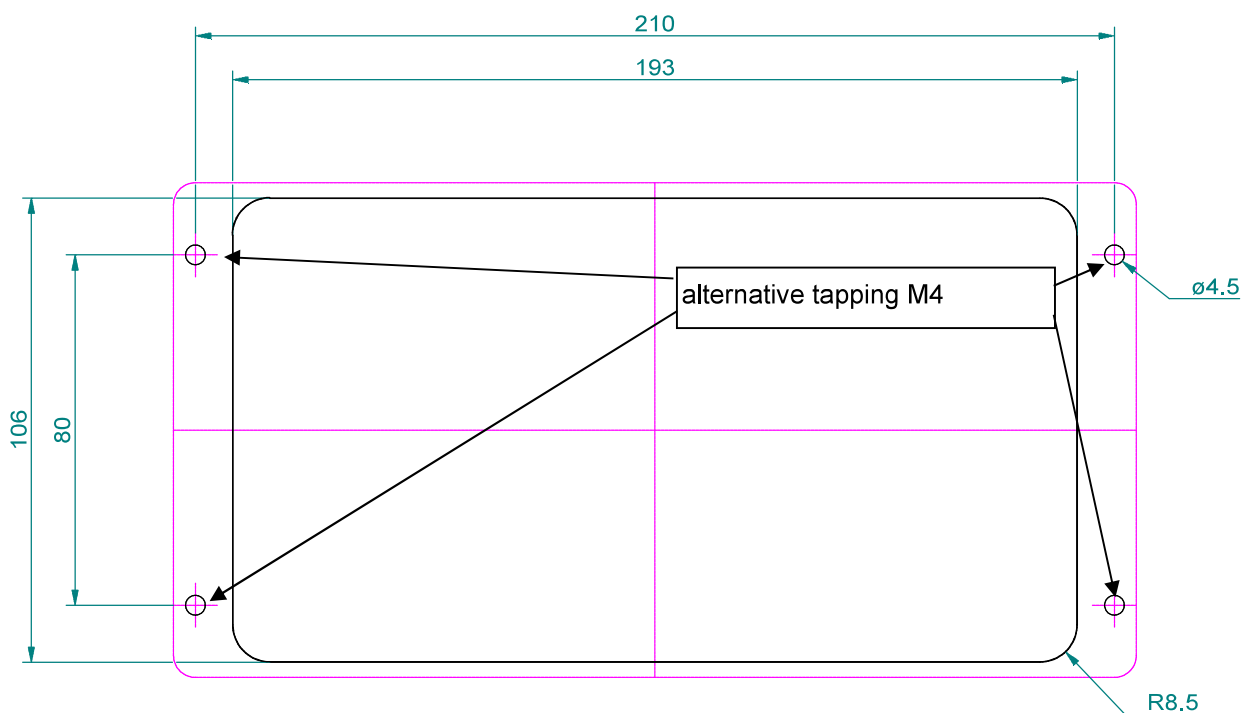

Fig. 98

NOTE

Choose installing position in a way, that the DCU is not exposed to excessive heat. In order to achieve good reading, on vessels the installing position of the DCU should be situated within the range of view of the control desk.

Installing

- Make sure, that there are no endangered elements (e.g. wiring, gas- or water pipes) within the range of the installing cut-out.
- Cut out attached mounting template, transfer the 4 fixing holes and the installing cut-out to the mounting surface.
- Drill the four 4.5 mm holes for the fixing screws or tap four M4-threads into the mounting surface, in order to achieve comfortable installing from the front.
- Cut out the installing cut-out of the mounting surface.

- With a flat screwdriver screw the fixing M4 fastening bolts in the screw jacks of the DCU. Do not tighten the bolts to hard. If, at the attachment site, noticeable vibrations occur (e.g. diesel generator), secure the bolts with LOCTITE®-Threadlocker.
- Plug in the connectors for power supply, bearing antenna and other additional devices.
- Place the DCU into the installing cut-out and fix it using the delivered M4 allen screws.

ATTENTION

In case of strong UV radiation, the front foil of the DCU can age and break. This could allow water to enter into the device. As a result, the function of the electronics is not guaranteed.

Recommendation:

- The front cover of the DCU must be checked for damage regularly.
- The front foil, which is under constant influence of UV, has to be exchanged every 5 years; otherwise damage of the equipment is possible.

7.1.2 Connecting Power Supply

The „Power Connector“ (see Fig. 2 ⑤) is connecting the DCU and power supply.

Wiring pattern:

PIN 5: GND (ground respectively negative pole).

PIN 9: Voltage supply (+12 ... 28V)

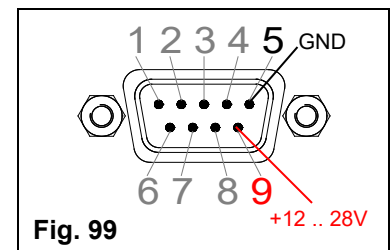

Fig. 99

ATTENTION

- The power supply has to be equipped with a fuse of 1A, inert.
- If the bearing system is to be operated floating, a DC/DC converter has to be adapted between Battery and DCU. The GND-connection is connected galvanically to the housing!

The content of delivery contains a prepared power supply cable. The red cable with integrated fuse holder is to be connected to the positive pole of the voltage supply (+12V ... 28V). The black cable is to be connected to the negative pole of the voltage supply.

ATTENTION

We strongly point out, that reversing polarity of the poles will damage the system! Never connect the black cable (PIN 5) to positive voltage. PIN 5 is connected to the ground of the housing and causes a short circuit, which damages the system!

7.1.3 Connecting the DCU to Ground

The ground connector (Fig. 2 ⑥) of the bearing system has to be connected to the ground of the vehicle. For stationary installations the ground connector has to be connected to earth potential. Use cables of sufficient cross-sectional area.

ATTENTION

The antenna's ground is connected to the DCU. Electrostatic charge may cause very high voltages. Therefore, it is very important earthing the DCU before connecting the antenna.

7.1.4 Connecting Antenna

Connect antenna cable (see 7.3) to socket "Antenna Connector".

7.2 Determination of Antenna Position

The quality of the bearing results is depending largely on the antenna's position. Therefore, an antenna position has to be found, where the transmitter's wave field can reach the bearing antenna as undisturbed as possible.

The bearing antenna is analysing the incoming wave field and the microprocessor of the bearing system is determining the direction of incidence of the signal. Reflections of the incoming signal may interfere with the wave field. The bearing system will determine a direction of incidence as an average of the incoming and the reflected signal. As a result, there is a wobbling bearing display, the error will depend on direction of incidence, distance and vertical angle of incidence of the signal.

Reflections mainly are caused by conducting objects.

- Antennas (especially if working in the same frequency range → GPS-antennas not that critical)
- Metallic superstructures of vessels
- Metallic masts
- Steel cables
- Wet sail-cloth
- Persons in direct vicinity of the antenna

Therefore, the best position of the antenna is on top of the mast, above other antenna systems or other obstacles.

In practice, often a compromise has to be found between bearing and other interests.

Therefore we will give you here some guidelines:

- No disturbing objects in the antenna's horizontal plane if possible
- Disturbing objects as distant as possible
- No metallic objects closer than 30 cm under and above bearing antenna
- No objects in direct antenna range (between antenna beams of antenna, except mast)

In the case of doubt the antenna's position has to be tested during a practical try-out, prior to final assembly.

Example Fig. 100:

- Position ①: bearing optimal
- Position ②: bearing good
- Position ③: bearing sufficient
- Position ④: bearing sufficient

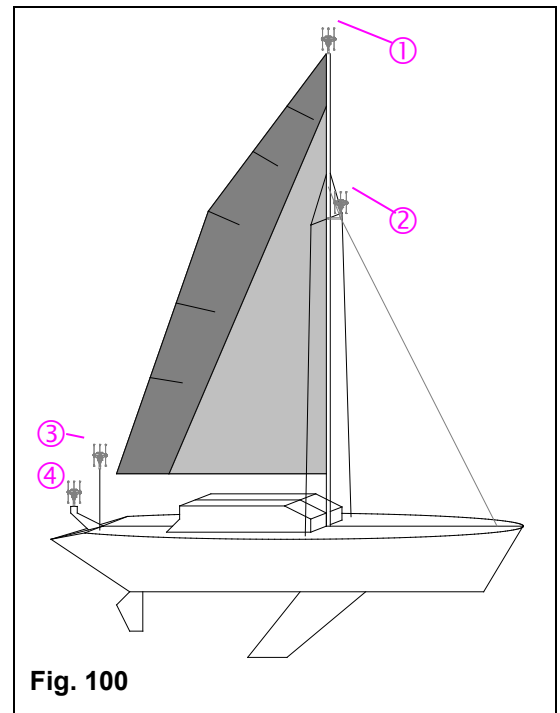

7.3 Completing Antenna Cable

The delivery contains an antenna cable of 10m length. First of all this cable is intended for testing operation of the system. Usually a special cable connection has to be put together for the final assembly. The content of delivery contains the required plugs and mounting material.

7.3.1 Type of Cable

The connecting cable antenna \Leftrightarrow DCU has to have following features:

- Cable length up to 50 m:

Cross-sectional area: min. AWG 24 (0,23mm²),

Number of wires: 9-poled (or more) + shield

Type of cable: control cable; twisted wires not required. The type of cable in detail is depending on local requirements (fire protection, oil resistance, heat...).

If there are no special requirements, a cable of type LiYCY10X0,25mm² may be used.

DC resistance of the shield: $\leq 15.7 \Omega / \text{km}$

- Cable length up to 100 m:

Cross-sectional area: min. AWG 22 (0,38 mm²),

Number of wire pairs: 12-poled twisted in pairs (or more) + shield

DC resistance of the shield: $\leq 6,4 \Omega / \text{km}$

Type of cable: control cable; wires twisted in pairs. The type of cable in detail is depending on local requirements (fire protection, oil resistance, heat...).

If there are no special requirements, a cable of type LiYCY6x2x0,50 mm² (METROFUNK KABEL-UNION) may be used.

7.3.2 Connecting Pattern of Antenna Cable:

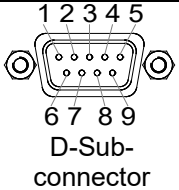
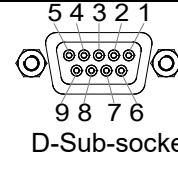
Antenna		DCU		
 <p>1 2 3 4 5 6 7 8 9 D-Sub-connector</p>		 <p>5 4 3 2 1 9 8 7 6 D-Sub-socket</p>		
Kontakt		Kontakt	Signal-name	Signal
1	↔	1	ANT-EAST	control signal east
2	↔	2	ANT-WEST	control signal west
3	↔	3	RS485/A	data signal
4	↔	4	RS485/B	data signal
5	↔	5	12...28V	voltage supply
6	↔	6	ANT-SOUTH	control signal south
7	↔	7	ANT-NORTH	control signal north
8	↔	8	NF	audio signal
9	↔	9	PHI	bearing signal
Shield	↔	Shield	GND	ground

NOTE

The shield resistance of the cable between the antenna and DCU must not be greater than 2 Ohms.

Connecting pattern for cable lengths up to 50 m:

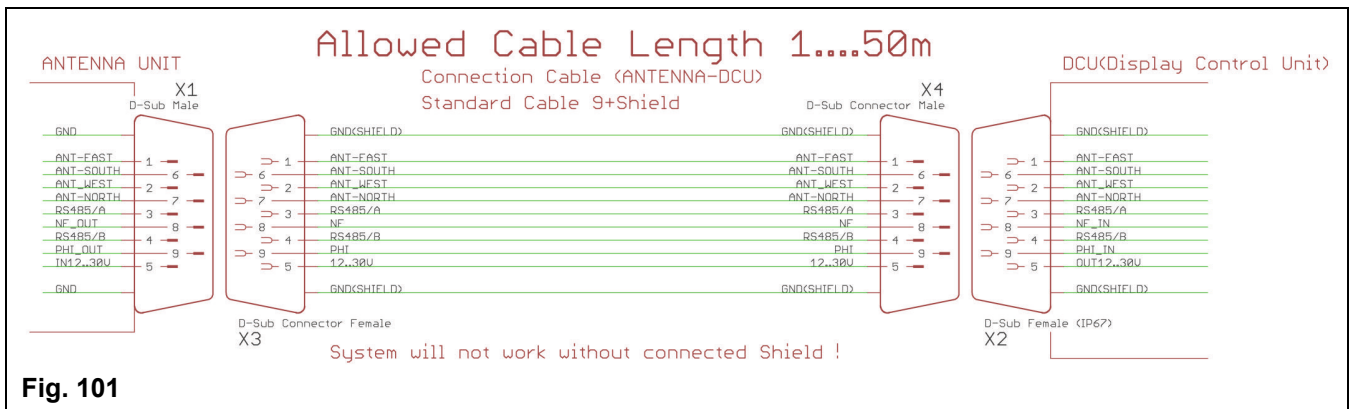
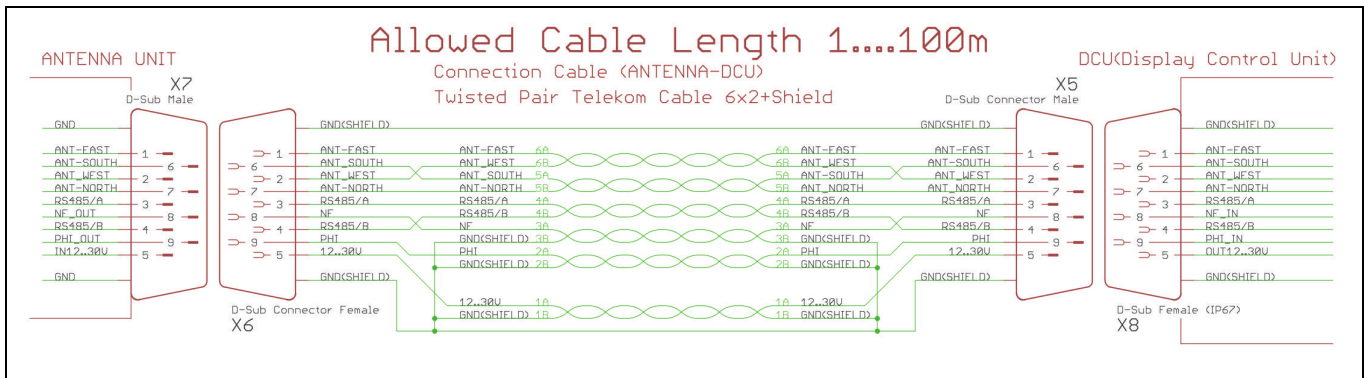

Fig. 101

Connecting pattern for cable lengths up to 100 m:



NOTE

With the cable LiFYCY6x2x0,50mm² (Metrofunk Kabel-Union), an operation with up to 350m cable length is possible. The necessary operating voltage of the device with > 100m cable length is 24V.

7.4 Installing the Antenna

The antenna is to be mounted on a suitable mast tube.

The antenna is delivered either with a 6-holed flange ② or with a threaded flange ③ (the flange may be changed if required). The counterpart for the 6-holed flange on the vessel side is to be produced according to the drawing ①.

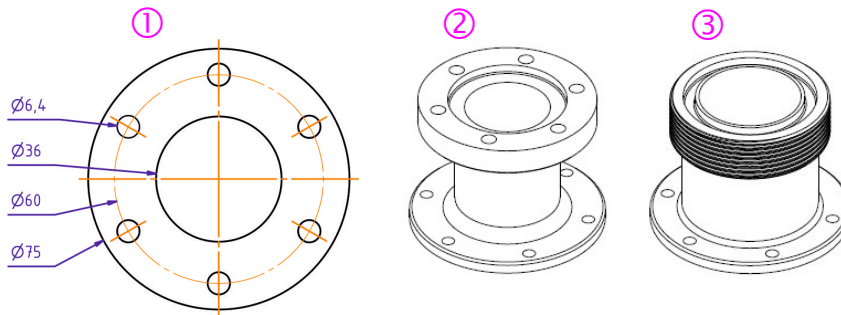

Fig 102

7.4.1 Fixing Screw Joint on Mast Tube

If the antenna is delivered with a screw joint a suitable plastic screw joint is added ⑤⑥. The screw joint is provided for mast tubes with an outside diameter of 50 mm (respectively 40 mm with added reduction). Preferably the mast tube ⑦ is consisting of plastic.

Put the compression nut ⑤ (threaded side to the top) onto the mast tube ⑦. Stick together mast tube ⑦ and flange ⑥ with suitable cement - use added reduction for mast diameter of 40 mm. On request there are reductions for other mast diameters.

7.4.2 6-Holed Mast Flange

If applying the 6-holed flange, the counterpart for the mast is not added and has to be manufactured by oneself. Keep care to align the pitch circle in a way, that one of the holes is situated in the longitudinal axis of the vehicle.

7.4.3 Installing Antenna Cable with Pull-Relief

Pull antenna cable through mast tube. The socket (female) has to point to the antenna. For cable lengths of more than 10 m a pull-relief has to be mounted.

In any case, we recommend installing the pull-relief ④ (in content of delivery) between mast and antenna. Only in this case the antenna system is waterproof (IP 67). The pull-relief has to be installed before mounting the antenna (if using the added antenna cable, the pull-relief cannot be used).

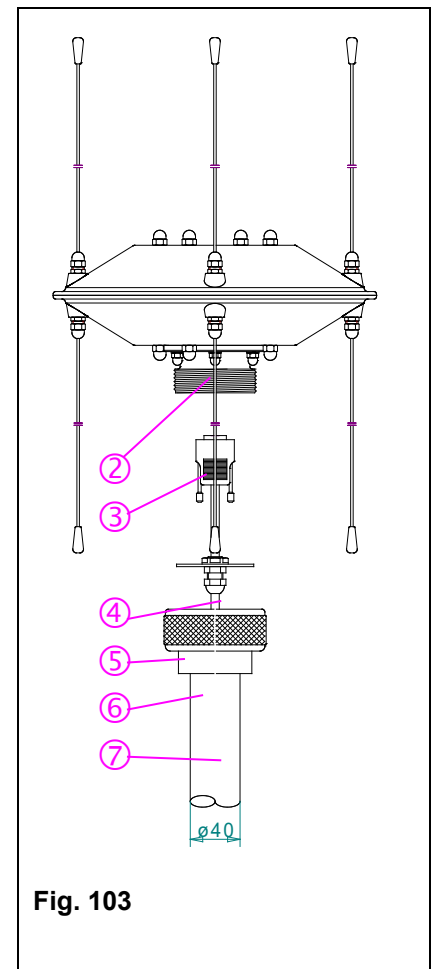

Fig. 103

7.4.4 Fixing the Antenna

- Connect antenna cable and antenna, tighten check-screws.
- Put antenna to the mast-flange. Take care, that the o-ring of the antenna flange is fitting firmly into its groove.
- Tighten slightly the compression nut (threaded flange).
- Align antenna, the arrow-marked dipole pointing exactly in the longitudinal axis of the vehicle.
- Tighten firmly screw joint.
- If using the 6-holed flange, mount antenna with the arrow pointing to the vehicles direction.
- For stationary use, mount antenna with the arrow pointing to the north.

7.4.5 Aligning Antenna for Mobile Use

Before putting into operation the bearing system, the bearing antenna is to be aligned exactly.

For vessels and land vehicles the reference direction is the longitudinal axis of the vehicle. The bearing antenna should be aligned in a way, that the arrow-marked pair of beams is pointing parallel to the longitudinal axis to the bow respectively to the front of the vehicle. By means of a transmitter, the correct alignment can be verified. In case of an inevitable, unfavourable antenna position, antenna axis and vehicle axis may not coincide (offset) due to reflexions.

7.4.6 Aligning Antenna for Stationary Use

For stationary use the reference direction of the antenna is magnetic north (QDR) or geographic north (QTE).

ATTENTION

Touching the antenna during rotation will be considerably distorting the bearing result. Before reading the bearing results at the DCU, take care that there are no persons in the vicinity of the antenna.

- Aligning for reference direction magnetic north (QDR, from direction finder to transmitter):
 - a) A transmitter is to be put up in a distance of at least 100 m from the bearing antenna.
 - b) Determine the direction to the bearing antenna by means of a compass.
 - c) Add or subtract to compass value 180° , thus obtaining the nominal value.
 - d) Switch on transmitter, transmitting continuously.
 - e) Align antenna in a way, that the display is indicating the nominal value.
 - f) Tighten screw-joint of antenna.

For verifying purposes the adjustment has to be checked for different directions of transmission. In case of (untolerable) deviations, change position of antenna.

- Aligning for reference direction QDM (magnetic course from transmitter to direction finder):
To be done as described in "Aligning for reference direction magnetic north QDR", only the nominal value has to correspond to the determined compass value.
- Aligning reference direction QUJ (true compass bearing from transmitter to direction finder):
To be done as described in "Aligning for reference direction QDM", only the local variation has to be subtracted from the nominal value.
- Aligning reference direction QTE (true course from direction finder to transmitter):
To be done as described in "Aligning for reference direction magnetic north QDR", the local variation has to be subtracted from the nominal value.

7.4.7 Mounting of Antenna Beams

Put antenna beams into receptacles of the antenna head, until the fitting is resting fully in the groove of the drilling (see Fig. 104). Fully tighten by hand the compressing nut until feeling distinct resistance. Tighten nuts by using a wrench (10 mm), with a torque not exceeding 3 Nm. Don't bend antenna beams in order to avoid bearing errors.

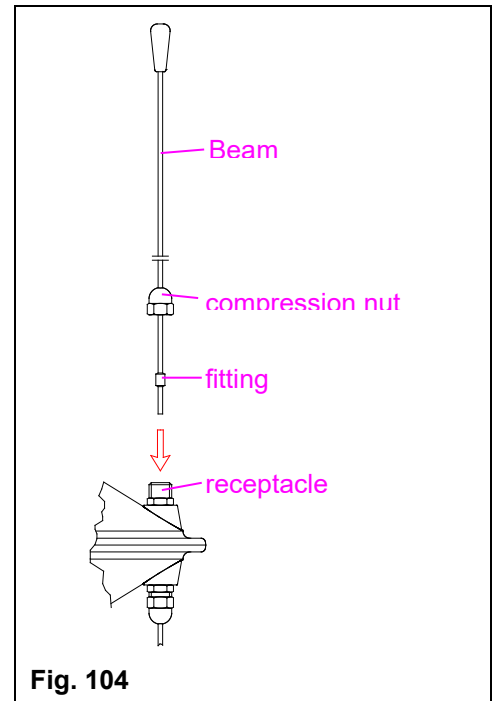

7.5 Configuring Setup

Once antenna and DCU connected to the power supply, the bearing system will work already. The factory defaults are set (see 6.2.1.5.6) in a way, that all standard functions are activated.

The bearing system is offering a great number of functions, different settings and external devices may be connected. In order to be able to use these features, some adjustments have to be made prior putting into operation the system. The following chapter is to support you for this work.

Procedure:

Pos	Menu	Action	Default	See chapter.	Remarks
01	Light	Adjusting brightness of LCD	100%	6.2.1.1.1	
02		Brightness of keyboard	50%	6.2.1.1.2	
03		Brightness LED-circle	100%	6.2.1.1.3	
04	Bearing	Select reference direction for digital bearing value display <ul style="list-style-type: none"> - REL (relative bearing) - MAG (magnetic bearing → reference direction magnetic north) - TRU (true bearing → reference direction geographic north) 	REL	6.2.1.2.1	For reference directions MAG and TRU the source of compass data has to be defined in menu <i>COMPASS</i> . If using an external compass, in menu <i>SERIAL</i> the interface has to be defined.
05	Sounds	Adjusting keyboard volume - BEEP VOLUME	50%	6.2.1.4.1	Adjust volume audible, but not disturbing.
06		Adjusting volume alarm signal - ALARM VOLUME	100%	6.2.1.4.2	
07	Setup Bearing	Bearing value averaging memory - AVERAGE	5	6.2.1.5.1.1	A higher value is only useful, if drag error compensation is activated (drag error will increase). Smaller values cause nervous display.
08		Adjusting source for heading compensation. <ul style="list-style-type: none"> - OFF: no heading compensation - TRUE: source of heading compensation has reference direction true north - MAG: heading compensations has reference direction magnetic north - INT: heading compensation by internal compass 	OFF	6.2.1.5.1.2	Only one source can be selected, which is actually available. If selecting MAG or TRUE a corresponding compass signal has to be connected. If selecting INT, the internal compass module (optimal) has to be integrated. If there is an external compass connected, it should be used as a source.
09		Selecting mounting direction of antenna. <ul style="list-style-type: none"> - NORM (normal mounting) - INVERS (mounting upright down) 	NORM	6.2.1.5.1.3	
10		Adjusting correcting value - Offset	0°	6.2.1.5.1.4	With the correcting value constant bearing errors may be compensated, e.g. caused by misalignment.

Pos	Menu	Action	Default	See chapter.	Remarks
11		Extended display - LAST TIME	10 sec.	6.2.1.5.1.5	Adjusting only recommended, if factory default is not optimal.
12		Activating heading compensation for repeat function - LAST VALUE COMPENSATION	OFF	6.2.1.5.1.6	Only possible, if external or internal compass is available.
13	RECEIVER	Selecting frequency mode in maritime band - CHANNEL MODE	ON	6.2.1.5.2.1	Default setup reasonable, for frequency tuning in maritime band usually by entering channel number.
14		Selecting starting setup (POWER ON DEFAULTS)	ON	6.2.1.5.2.2	If the device is to restart with last tuned frequency / channel number the setting "OFF" has to be selected.
15	SERIAL	Selection of serial interface for data reception - RS-232 - NMEA (RS-422) - RS-485	RS-232	6.2.1.5.3.1	Required only, if external devices connected. Adjustments are depending on connected device.
16		Adjusting data transmitting velocity (BAUD RATE)	4800 Baud	6.2.1.5.3.2	
17		Adjusting device addressing (IDENTITY)	000	6.2.1.5.3.3	
18		Selecting type of transmission (TALK MODE)	AUTO	6.2.1.5.3.5	
19		Adjusting transmitting interval (in auto-talk-mode) (TALK TIME)	250 ms	6.2.1.5.3.6	
20	COMPASS	Selecting data source for reference direction true north (TRUE SOURCE)	NMEA XXHDT	6.2.1.5.4.1	
21		Selecting reference direction for magnetic north (MAG SOURCE)	NMEA XXHDT	6.2.1.5.4.2	

8 Maintenance and Cleaning

8.1 Maintenance

UV irradiation can age the front foil of the RT-300 DCU with time, which can lead to brittleness of the front foil.

Depending on the operating conditions of the RT-300 DCU, there is the possibility that moisture can penetrate through small hairline cracks in the front foil. An impairment of the functionality up to the damage of the product can result.

RHOTHETA Elektronik recommends the replacement of the front foil of the RT-300 DCU every 5 years.

The exchange of the front foil may only be done by RHOTHETA Elektronik GmbH or an authorized maintenance facility; otherwise, this will void the warranty.

8.2 Cleaning

RHOTHETA Elektronik recommends cleaning the RT-300 with warm water and a microfiber cloth. Persistent stains can be washed with a dishwashing detergent. Do not use any abrasives or cleaning agents containing alcohol.

9 Product Disposal

9.1 Disposal within the European Union

Product Disposal



■ Product labeling according to EN 50419

At the end of product life, this product may not be disposed together with normal household waste. Even disposal via the municipal waste disposal collection for electrical and electronic equipment is not permitted.

The correct disposal of this product helps to protect the environment and prevent any potential damage to the environment and human health, which can occur due to improper handling of the product.

- Therefore, supply the device to an electronics collection point for recycling after the product being finally taken out of service.

Or

- The RHOTHETA Elektronik GmbH takes back all products that are subject to the requirements of the WEEE Directive (2012/19/EU) of the European Union to supply these products to professional disposal.

9.2 Disposal outside the European Union

For disposal of the equipment in accordance with national regulations in countries outside the European Union, ask your dealer or local authorities.

10 Appendix

10.1 Wiring Pattern (recommended RT-300 DCU connections plan)

The drawing “Recommended RT-300 DCU connections plan” is attached on an extra sheet.

Recommended RT300 DCU Connections Plan

all external connections except Power Supply and Antenna are optional

Recommended Cable Connection to PC for Software Update

PC-COM Port Standard Cable 9+Shield

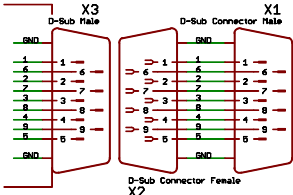

DCU (Display Control Unit)

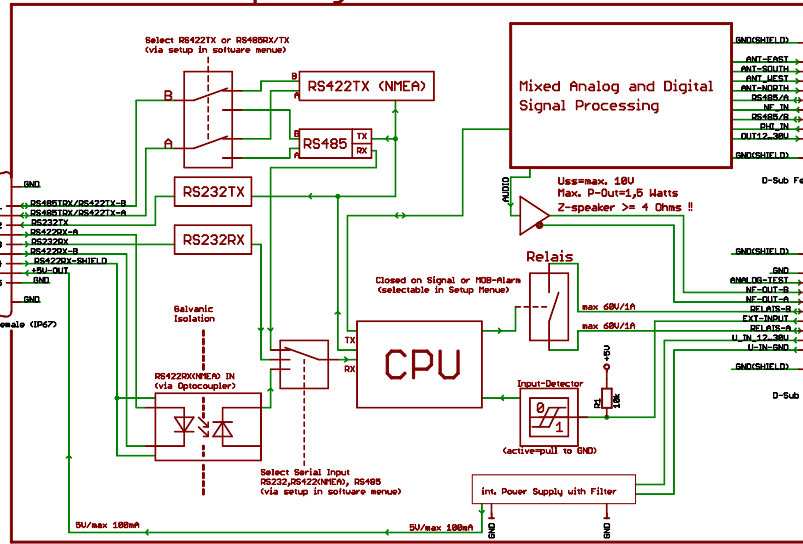

RS232 Device
(Logging, Software Update, Remote Control, Seamap,....)

NMEA Transmitter
(Gyro, Compass, GPS, Remote Control...)

NMEA Receiver
(Seamap, Logging Console, Daughter Display,.....)

DC-Power Supply
12..30U/1A

DC-DC Converter
only if Galvanic Isolation required
optional

Uss= max. 10U
P-Out= 1,5 Watts
2-speaker >= 4 Ohms !!

Closed on signal or MOB-Alarm
(selectable in Setup Menu)

Select Serial Input
RS232, RS422(NMEA), RS485
(via setup in software menu)

Select RS422TX or RS485RX/TX
(via setup in software menu)

Select RS422RX(NMEA) IN
(via Optocoupler)

Allowed Cable Length 1....100m

Connection Cable (ANTENNA-DCU)
Twisted Pair Telekom Cable 6x2+Shield

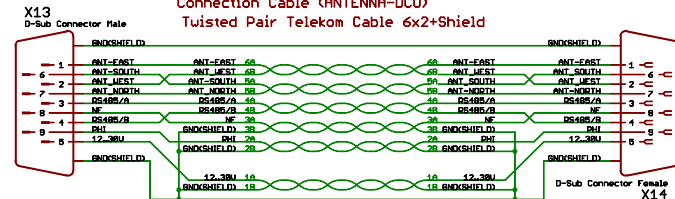

Allowed Cable Length 1....50m

Connection Cable (ANTENNA-DCU)
Standard Cable 9+Shield

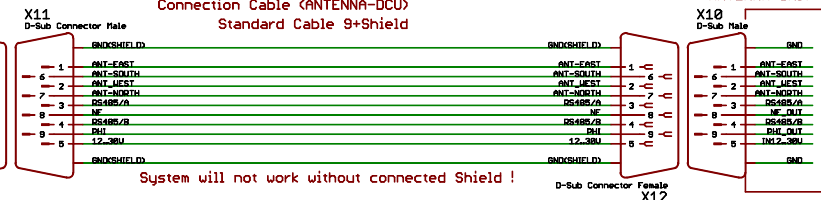

System will not work without connected Shield !

External Speaker
4..600 Ohms
max Input >= 2Watt

Dont connect NF-OUT A or B dc to ground !
DCU will be destroyed !!

GPS
(MOB Input)

or
ALARM device
(Bell, Light...)

UHF/UHF COM
Transmit PTT

For other external connections contact Rhotheta
DCU could be damaged !!

Revision	Date	ChangeIndex	Date	Checked	Name	RT300	Project
01.00	0	A		16.10.2003	F. Boehm	Connection Plan DCU	Project
01.01	1	B		11.02.2005	F. Boehm		
	2	C				Drawing No.:	Designation:
	3	D					
	4	E					
	5	F					
	6	G					

 RHO Netzwerk GmbH	Internet www.rhotheta.de	Drawing No.:
Last Edit: 14.03.2006 12:55:02 Printed: 14.03.2006 12:55:32 Filename: Connection Plan DCU		Page: 1/1