

# User Manual

## **RT- 600** (SAR-DF-517)

Wideband Airborne Radio Direction Finder

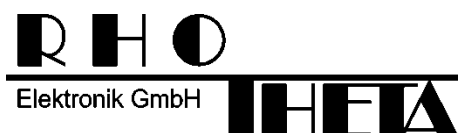

Edited by:

RHOTHETA Elektronik GmbH  
Kemmelpark  
Dr.-Ingeborg-Haekkel-Str. 2  
82418 Murnau  
Germany

Tel.: +49 8841 4879 - 0  
Fax: +49 8841 4879 - 15

Internet: [www.rhotheta.de](http://www.rhotheta.de)  
E-Mail: [email@rhotheta.de](mailto:email@rhotheta.de)

*Copyright © RHOTHETA Elektronik GmbH  
All rights reserved  
- Issue: 2020/10/07 [Rev 3.05]  
- Document-ID: 12-9-4-5-00003-61*

*LoJack is a registered trademark of LoJack Corporation.*

**Note**

The manufacturer reserves the right to make modifications at any time and without previous information of the here described product.

**Content**

<b>1</b>	<b>General information .....</b>	<b>6</b>
1.1	Purpose of Use .....	6
1.2	Scope of delivery .....	7
1.2.1	RT-600 A (PN: RT-8610).....	7
1.2.2	RT-600 A NVIS (PN: RT-8611).....	7
1.2.3	RT-600 A NVIS (PN: RT-8611-001) .....	7
1.2.4	RT-600 LE (PN: RT-8620).....	7
1.2.5	RT-600 LE NVIS (PN: RT-8623).....	7
1.2.6	RT-600 LE NVIS (PN: RT-8623-001) .....	7
1.2.7	RT-600 Option ARINC 429 (PN: RT-8610-020) .....	7
1.3	Main system configuration settings .....	8
<b>2</b>	<b>Operating .....</b>	<b>9</b>
2.1	General Operating Principles .....	9
2.1.1	Push-buttons with double function.....	10
2.1.2	Power-On Procedure .....	11
2.1.3	Main Pages Selection .....	11
2.1.4	Dimming function .....	12
2.1.5	Squelch Operation .....	12
2.2	Frequency (FRQ) Selection Page .....	15
2.2.1	Selecting a Frequency .....	15
2.2.2	Recalling and editing frequencies from a memory channel.....	15
2.2.3	Recalling frequencies from fixed frequencies or COSPAS-SARSAT Channels .....	16
2.2.4	Editing a Frequency .....	17
2.2.5	Selecting a Frequency Band.....	18
2.3	Direction Finder (DF) Mode .....	19
2.3.1	Operating Elements in DF Mode .....	19
2.3.2	Standard Display in DF Mode.....	20
2.3.3	Special Options in COSPAS-SARSAT DF Mode .....	20
2.3.4	COSPAS-SARSAT Decode Window.....	21
2.3.5	Tracking 121.500 MHz while in COSPAS-SARSAT Mode.....	22
2.3.6	COSPAS-SARSAT Scan Mode .....	23
2.3.7	Marine Ship Scan Mode .....	24
2.4	Law Enforcement Operation .....	26
2.4.1	Power-On Procedure .....	26
2.4.2	LoJack Scan Mode for a VLU Code .....	27
2.4.3	LoJack Scan Mode from any other page .....	27
2.4.4	Manual activation of LoJack Scan Mode .....	28
2.4.5	Receiving and accepting a new VLU Code .....	29
2.4.6	Entering a new VLU Code manually.....	29
2.4.7	Tracking one VLU Code while monitoring new VLU Codes .....	30
2.4.8	Tracking one VLU Code and receiving a new VLU Code .....	30
2.4.9	Switching to a new VLU Code .....	31
2.4.10	“Blocking” function of one LoJack VLU Code.....	31
2.4.11	Tracking in the 216 to 220 MHz band .....	32
2.5	Setup Edit Page.....	33
<b>3</b>	<b>Error messages .....</b>	<b>35</b>
<b>4</b>	<b>Installation .....</b>	<b>36</b>
4.1	Antenna Unit .....	36
4.1.1	Influence of antenna location and environment on the bearing accuracy .....	37

---

4.2	Display and Control Unit.....	39
4.3	System Interconnect Wiring Diagram.....	40
<b>5</b>	<b>Technical Data.....</b>	<b>41</b>
5.1	Electric Features.....	41
5.2	Interface.....	42
5.3	Mechanical Features.....	43
<b>6</b>	<b>Appendix.....</b>	<b>45</b>
6.1	Frequency Ranges.....	45
6.2	Frequencies of channels on maritime band.....	47
6.3	Serial interface data protocol (short description).....	48
6.3.1	General.....	48
6.3.2	Serial standard output (protocol description).....	49
6.3.3	DCU info output (protocol description).....	51
6.3.4	Optional extended serial output (protocol description).....	51
6.3.5	Optional serial input (protocol description).....	55

**List of figures**

Fig 1)	RT-600 Airborne Direction Finder System.....	7
Fig 2)	RT-600 DCU Front Panel Layout .....	9
Fig 3)	Push buttons / short-time keypress .....	10
Fig 4)	Push buttons / longer-time keypress .....	10
Fig 5)	Power-On Screen .....	11
Fig 6)	Page Selection.....	11
Fig 7)	Dimming Adjustment.....	12
Fig 8)	Manual squelch mode, correct squelch adjustment .....	14
Fig 9)	Manual squelch mode, Incorrect squelch adjustment .....	14
Fig 10)	Automatic squelch mode .....	14
Fig 11)	Automatic squelch mode with strong signal .....	14
Fig 12)	Automatic squelch mode and not adjustable by the user .....	14
Fig 13)	Open FRQ Page.....	15
Fig 14)	FRQ – Frequency Selection Page.....	15
Fig 15)	Recall frequency of Memory channel 3 .....	15
Fig 16)	FRQ Selection Page with FIX1 selected .....	16
Fig 17)	FRQ Selection Page before frequency editing .....	17
Fig 18)	FRQ Selection Page after frequency editing .....	17
Fig 19)	FRQ Selection Page (bands).....	18
Fig 20)	Operational Elements in DF Mode .....	19
Fig 21)	DF Mode .....	20
Fig 22)	Operational Elements and Display in COSPAS-SARSAT DF Mode.....	21
Fig 23)	COSPAS-SARSAT Beacon Information Page .....	22
Fig 24)	Tracking 121.500 MHz while in COSPAS-SARSAT Mode.....	23
Fig 25)	FRQ Selection Page with SCN COSPAS-SARSAT Scan Page selected.....	23
Fig 26)	DF page with active COSPAS-SARSAT Scan Mode at the DF page .....	24
Fig 27)	DF Mode, FRQ = 156.800 MHz, F1 for scan function .....	24
Fig 28)	DF Mode, active scanning in process.....	25
Fig 29)	STARTUP Screen (see 2.1.2 for details).....	26
Fig 30)	LoJack Scan Mode, unit is scanning for a LoJack VLU Code.....	27
Fig 31)	Hotkey F2 .....	27
Fig 32)	FRQ Selection Page, FRQ = LoJack, BAND = LoJack (164-174 MHz).....	28
Fig 33)	DF Mode with LoJack filter OFF .....	28
Fig 34)	LoJack Scan Mode with new VLU Code received.....	29
Fig 35)	LoJack Scan Mode with new VLU Code entered manually.....	29
Fig 36)	DF Mode with active VLU Code and LoJack filter ON.....	30
Fig 37)	DF Mode with active VLU Code and announcement of new VLU Code .....	30
Fig 38)	LoJack Scan Page with one active VLU Code and one new VLU Code.....	31
Fig 39)	LoJack Scan Page with one active VLU Code and audio OFF .....	31
Fig 40)	Accessing the Setup Page .....	33
Fig 41)	Setup Page .....	33
Fig 42)	Error Messages .....	35
Fig 43)	Antenna Mounting Drawing .....	36
Fig 44)	Antenna installed in a bad location.....	37
Fig 45)	Antenna installed in good locations .....	38
Fig 46)	DCU Mounting Drawing, all dimensions in [mm] .....	39
Fig 47)	System Interconnect Wiring Diagram .....	40
Fig 48)	DCU Mechanical Drawing (all dimensions in [mm]) .....	44
Fig 49)	AU Mechanical Drawing (all dimensions in [mm]) .....	45
Fig 50)	Timing of serial data .....	48

# 1 General information

RHOTHETA Elektronik GmbH is the developer and manufacturer of the Direction Finder System RT-600. In the United States of America, the system has also been marketed under the system designation SAR-DF 517.

## 1.1 Purpose of Use

The RHOTHETA direction finder system RT-600 or SAR-DF 517 is designed to receive and locate emergency signals and special application signals on the international distress and application specific frequencies in the VHF / UHF frequency range.

The system consists of the Display Control Unit (DCU) RT-600 DCU and the Antenna Unit (AU) RT-600 AU and it is typically mounted on aircraft, both manned and unmanned.

The RT-600 is a modern precision direction finder intended for professional SAR (search and rescue) and LE (Law Enforcement) purposes, and there are two versions of the RT-600:

- The STANDARD or “A” version receives and locates signals on all international VHF-UHF emergency frequencies, including marine channel 16 and all COSPAS-SARSAT channels.
- The LAW ENFORCEMENT or “LE” version receives and locates special signals tracked by law enforcement and special ops organizations, but it also receives and locates signals on international VHF emergency frequencies including marine channel 16 and all COSPAS-SARSAT channels.

The excellent performance of the RT-600 is possible due to our revolutionary patented antenna (small, robust, and wideband) and it's sophisticated bearing analyzing algorithms, which deliver quick and steady information.

The RT-600 was designed for usage in harsh conditions, mounted on aircraft or vehicles.

## 1.2 Scope of delivery

### 1.2.1 RT-600 A (PN: RT-8610)

- Display Control Unit RT-600 DCU [A] (PN: RT-8605)
- Antenna Unit RT-600 AU [A] (PN: RT-8602)
- Connector Kit (PN: RT-8503)
- User Manual (PN: RT-8699)
- Cable AU-DCU (PN: RT-28146) *(on request)*

### 1.2.2 RT-600 A NVIS (PN: RT-8611)

Display color is conform to “NVIS Green B” Standard and shifted in the "yellow" direction on the 1976 UCS chromaticity diagram.

- Display Control Unit RT-600 DCU [A] (N) (PN: RT-8606)
- Antenna Unit RT-600 AU [A] (PN: RT-8602)
- Connector Kit (PN: RT-8503)
- User Manual (PN: RT-8699)
- Cable AU-DCU (PN: RT-28146) *(on request)*

### 1.2.3 RT-600 A NVIS (PN: RT-8611-001)

Display color is conform to “NVIS Green B” Standard and shifted in the "green" direction on the 1976 UCS chromaticity diagram.

- Display Control Unit RT-600 DCU [A] (N) (PN: RT-8606-001)
- Antenna Unit RT-600 AU [A] (PN: RT-8602)
- Connector Kit (PN: RT-8503)
- User Manual (PN: RT-8699)
- Cable AU-DCU (PN: RT-28146) *(on request)*

### 1.2.4 RT-600 LE (PN: RT-8620)

- Display Control Unit RT-600 DCU [L] (PN: RT-8622)
- Antenna Unit RT-600 AU [L] (PN: RT-8621)
- Connector Kit (PN: RT-8503)
- User Manual (PN: RT-8699)
- Cable AU-DCU (PN: RT-28146) *(on request)*

### 1.2.5 RT-600 LE NVIS (PN: RT-8623)

Display color is conform to “NVIS Green B” Standard and shifted in the "yellow" direction on the 1976 UCS chromaticity diagram.

- Display Control Unit RT-600 DCU [L] (N) (PN: RT-8624)
- Antenna Unit RT-600 AU [L] (PN: RT-8621)
- Connector Kit (PN: RT-8503)
- User Manual (PN: RT-8699)
- Cable AU-DCU (PN: RT-28146) *(on request)*

### 1.2.6 RT-600 LE NVIS (PN: RT-8623-001)

Display color is conform to “NVIS Green B” Standard and shifted in the "green" direction on the 1976 UCS chromaticity diagram.

- Display Control Unit RT-600 DCU [L] (N) (PN: RT-8624-001)
- Antenna Unit RT-600 AU [L] (PN: RT-8621)
- Connector Kit (PN: RT-8503)
- User Manual (PN: RT-8699)
- Cable AU-DCU (PN: RT-28146) *(on request)*

### 1.2.7 RT-600 Option ARINC 429 (PN: RT-8610-020)

Available for RT-600 A and RT-600 LE (regardless of NVIS type).

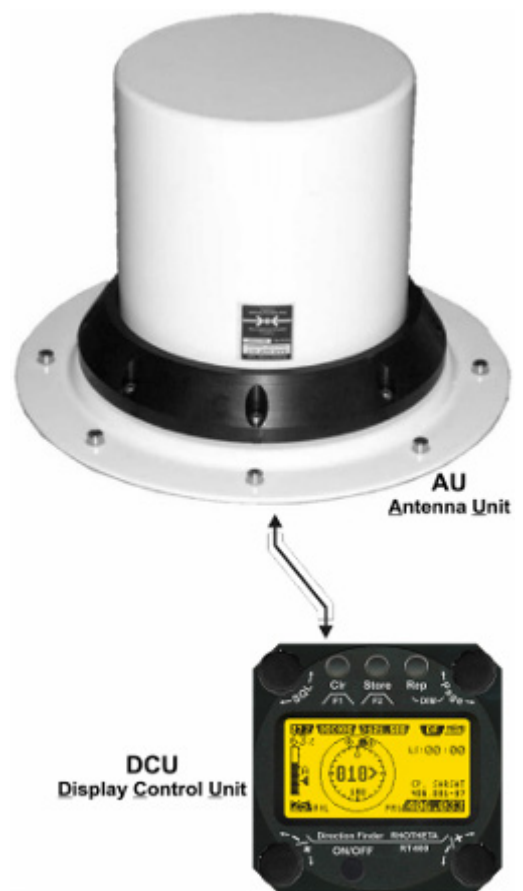

Fig 1) RT-600 Airborne Direction Finder System

### 1.3 Main system configuration settings

To guarantee a correct configuration and performance the user should verify – and change if necessary - the following configuration settings:

- MOUNTING TOP / BOTTOM: this parameter indicates if the Antenna Unit is mounted on a TOP or BOTTOM position
- EXTERNAL DIMMING MIN / MAX: if an external voltage is used for dimming the legends, the MAX and MIN parameters set respectively the low and high limits of the external analog voltage connected to Pin 8 of the RT-600 DCU “Power Supply” connector.

The above settings are available in the SETUP menu. For a detailed description see 2.5 Setup Page.



## 2 Operating

Operating the RT-600 direction finder is intentionally simple, due to its intuitive human machine interface. All operational settings are controlled from the RT-600 DCU Display and Control Unit.

The functions of PAGE knob and ON/OFF button are independent of the active page which is currently selected by the user.

### 2.1 General Operating Principles

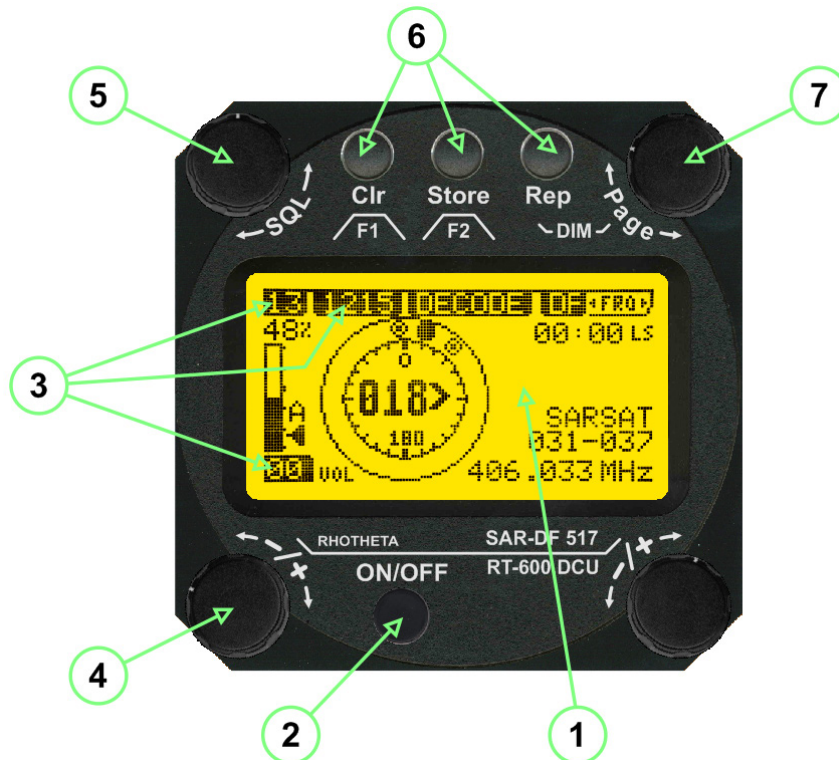

Fig 2) RT-600 DCU Front Panel Layout

- (1) **>LC Graphic Display<** (128 x 64 dots dot-matrix display, dark blue on yellow-green background) showing all relevant operational information depending upon the selected page.
- (2) **>ON/OFF<** Push-button to switch on / off the system.
- (3) **>Menu<** options for rotary and push buttons: If a field with dark background and bright text is shown below a button or switch, the function described in this field may be selected through the operational element above or below this menu field. In case of the Page Menu, the active page is high-lighted with dark background, while the inactive page is in black letters.
- (4) **>Volume<** Rotary Switch, used, depending on the active page, to adjust the volume of the audio output or to select frequency values (MHz steps).
- (5) **>SQL<** Rotary Switch, used depending on the active page, to adjust the squelch function or to select specific functions on a page depending upon the interactive menu on the display.
- (6) **Push-buttons** (see "Fig 3") in Chapter 2.1.1)
- (7) **>Page<** Rotary Switch, selects pages "DF" and "FRQ":
  - Page "DF" for direction finder standard bearing operation
  - Page "FRQ" for changing active frequency
 Also adjusts display brightness if used during DIMMING mode.

### 2.1.1 Push-buttons with double function

The three push-buttons (1), (2) and (3) can be used with two different effects.

#### Keypress for short-time (< 1 sec.)

- (1) **>F1<** Push-button. If pushed for a short time, this button activates the function F1 described in the interactive menu on the display below, which depends on the active mode and settings.
- (2) **>F2<** Push-Button. If pushed for a short time, this button activates the function F2 described in the interactive menu on the display below, which also depends on mode and settings.
- (3) **>DIM<** Push-Button. If pushed for a short time it activates the display DIMMING mode. (see 2.1.4)

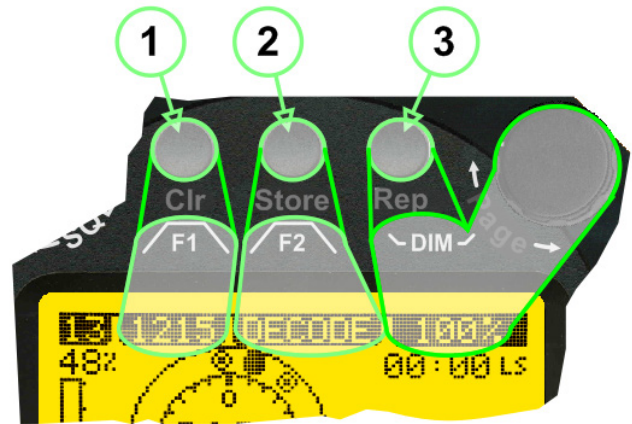

Fig 3) Push buttons / short-time keypress

#### Keypress for longer time (> 2 sec.)

- (1) **>CLR <** Push-button. If pushed for a longer time, this button activates the CLEAR function.
- (2) **>STORE<** and special key button. If pushed for a longer time and when using the RT-600 LE (LAW ENFORCEMENT) version, then the LoJack standard Scan page with all necessary settings is activated (fast-switchover). Otherwise the Store functionality is only available at the Setup Page (see 2.5 / Setup Edit Page).
- (3) **>Rep<** Push-Button. If pushed for a longer time (> 2 seconds) it activates the repetition of the last valid relative bearing and signal level information.



Fig 4) Push buttons / longer-time keypress

### 2.1.2 Power-On Procedure

After switching on the DCU pressing the ON/OFF pushbutton, a startup screen is displayed for five seconds.

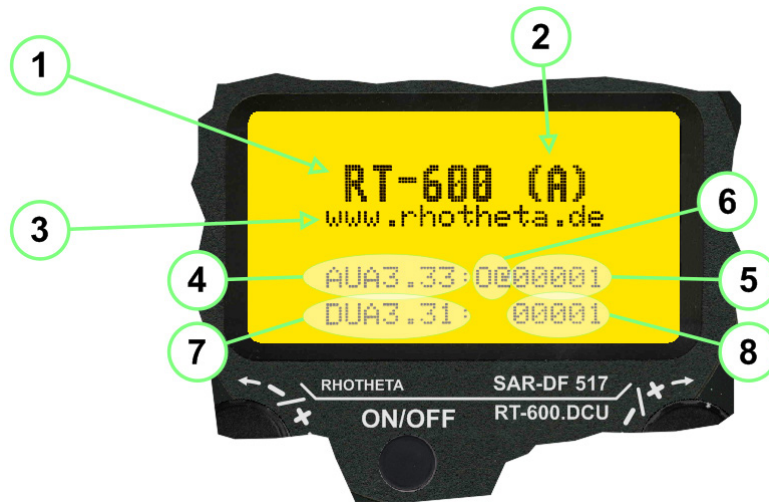

Fig 5) Power-On Screen

- (1) System Type: RT-600
- (2) System Version: “(L)” for LAW ENFORCEMENT version, or “(A)” for STANDARD version
- (3) Web Address (URL)
- (4) Software Revision of AU (antenna unit)
- (5) Serial Number of AU
- (6) Additional service and maintenance information (the two characters indicate installed options)
- (7) Software Revision of DCU (display control unit)
- (8) Serial Number of DCU

After five seconds, the equipment switches to the operational mode.

For LAW ENFORCEMENT version the LoJack Scan page is displayed as home page by default.

### 2.1.3 Main Pages Selection

Two main modes can be selected from the DCU front panel:

- **DF Mode** Page: displays all relevant operational bearing information depending on the type of signal being received.
- **FREQ SELECTION** Page: allows to access and edit all pre-programmed frequency memory channels.

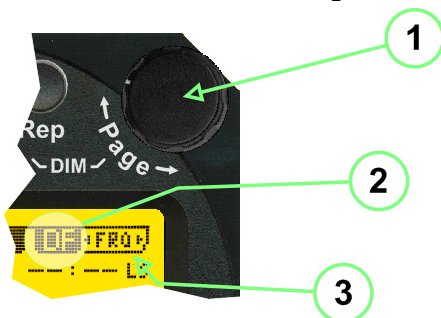
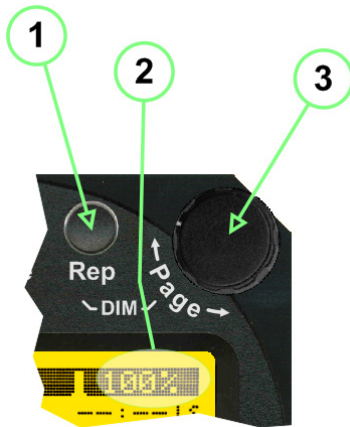

Fig 6) Page Selection

- (1) The **>Page<** rotary switch is used to select the active page.
- (2) The **active page** is highlighted with dark background.
- (3) The **inactive page**, which may be selected, is displayed in dark letters on bright background.

### 2.1.4 Dimming function

The background of the LC-graphic display is equipped with an LED array and its brightness may be adjusted continuously from 5 to 100%. Dimming follows an exponential curve, resulting in very accurate adjustment under night conditions.



- (1) Pressing the **>Rep/DIM<** button for a short time activates the DIMMING mode.
- (2) **Brightness**, actual information in percentage, from 5% to 100% in 5% steps, is displayed instead of the “Page” field in the upper right corner of the display.
- (3) The **>Page<** knob is used to adjust the brightness in 5% steps, left and right.

The active brightness level of the display will remain stored after switching off the unit separately for day and night/NVG mode.

Fig 7) Dimming Adjustment

After about 3 sec. of inactivity the display will fall back to the prior main page.

**Dimming of legends** can be adjusted in two ways:

#### Internal dimming of legends:

Internal dimming is always active. If an external dimming voltage is not used, or is < 1V DC, legends are dimmed in the same manner as the LC display.

#### External (remote) dimming of legends:

If the external dimming voltage is > 1V DC the brightness of the legends is controlled by the external dimming voltage.

Refer to the wiring plan (chapter 4.3) and to the Setup Edit Page (chapter 2.5).

### 2.1.5 Squelch Operation

The main challenge of operating a direction finder is trying to use only the signal transmitted by the target in order to calculate its bearing accurately, because noise and RF disturbances will cause misleading bearing indications.

In order to prevent the direction finder to calculate bearing results which are due to noise and disturbances, several techniques are available.

If a signal can be distinguished from noise or other signals by its message content (e.g. LoJack ID), only transmissions containing the required message content are used for bearing.

In other cases the squelch can be used to suppress unwanted weak signals and noise. A squelch level, called threshold has to be set by the user or automatically by the system. All signals with strength below this threshold value will be ignored, while signals with strength above this level will cause a bearing indication.

So for a signal to be usable for bearing calculation it has to be sufficiently stronger than noise or disturbing signals that the receiver can clearly distinguish between wanted and unwanted signals. As a result of the squelch technique the receiver sensitivity is reduced to the level set by the squelch threshold, decreasing the maximum distance or range to the transmitter.

However it might be desirable to obtain bearing information even for weak signals which are very close to the noise level. In this case it will be necessary to reduce the squelch level below the noise level. As soon as the modulation of a signal can be heard on the speaker, it can be expected that bearing calculation is possible.

If the noise is randomly distributed – as with “white noise” – and no other signal is received, the bearing indication will also be random. If the noise is not random but rather a specific disturbance, the bearing indication will point to the source of the noise.

If there is a very weak signal “buried” in the noise, this signal will produce a correct bearing indication thanks to sophisticated bearing technologies used in the RT-600 system. Fluctuations due to noise will be small even at low signal levels however the reaction time of the bearing indication can increase.

To verify if a bearing indication is due to white noise or to an internal disturbance source, or if it is due to a valid signal, the aircraft should make a slow turn. If the bearing indication is due to an external signal, e.g. a SAR beacon, the bearing indication should compensate the changed relative flight angle.

Example with a bearing indication of  $30^\circ$  and the signal is hardly audible as it is buried in the noise. The airplane makes a turn left by  $60^\circ$ . If the bearing indication is not changing to approximately  $30^\circ + 60^\circ = 90^\circ$  after a few seconds, the bearing is likely to be due to noise or internal disturbances from the aircraft.

**Note**

The weaker a signal is, the longer it will take to change the bearing. Durations around 5 seconds are not unfamiliar in such cases. Therefore, it is not useful to use this procedure for signals with short transmission times and low transmit duty cycles, such as COSPAS-SARSAT transmission. The procedure is best suited for ELT transmission with a continuous signal and still well-suited for ELTs with intermittent transmission (down to 33%).

In cases where pulsed signals are to be received, the receiver is able to decide automatically which squelch level is best-suited for normal operation. In such cases an automatic (“A”) squelch is provided. The threshold is automatically set to a value higher than the calculated noise level. The difference in dB between noise and threshold level can be defined in the Setup Menu. Refer to the chapter “Setup Page” for details. During AUTO squelch operation the user has the possibility to force the squelch into MANUAL mode, but needs to be aware of the operational limitations described in this chapter.

In cases where the Antenna Unit checks signal validity autonomously and without useful possibilities of user interaction, user interaction is not possible and the squelch purely follows internal rules appropriate to the type of signal received.

Examples of different squelch settings:

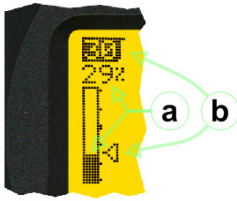

Fig 8) Manual squelch mode, correct squelch adjustment

**Correct squelch adjustment:**

If the squelch is set to level (b) slightly over the noise level (a) the receiver audio output remains quiet and no wrong, noisy bearing is indicated.

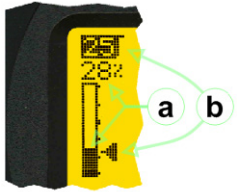

Fig 9) Manual squelch mode, incorrect squelch adjustment

**Incorrect squelch adjustment:**

If the squelch level is set (b) below the noise level (a) a wrong, noisy bearing is indicated.

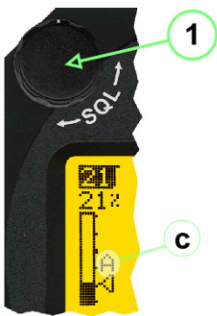

Fig 10) Automatic squelch mode

**Automatic squelch mode:**

Automatic squelch mode is indicated by an "A" (c) above the squelch level marker. Depending on the SN-Ratio setting, the squelch level is automatically set slightly higher than the noise level. Using the SQL rotary switch (1), the user can change to **manual squelch mode**. Automatic squelch mode can be activated again by setting the squelch level manually to < 0 % or > 60 %.



Fig 11) Automatic squelch mode with strong signal

**Automatic squelch mode with strong signals:**

Strong, short receive signals will not modify the squelch level setting.

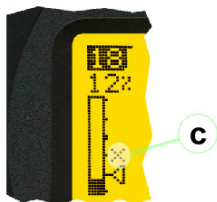

Fig 12) Automatic squelch mode and not adjustable by the user

**Automatic squelch mode, level not re-adjustable by user:**

When the squelch is adjusted automatically by the system, and the user is not allowed to change it, an "X" (c) is displayed above the squelch level marker.

## 2.2 Frequency (FRQ) Selection Page

The Frequency Selection (FRQ Selection) Page allows the user to select a frequency, select a band, and edit a frequency.

### Open FRQ Page:

From the “DF” standard page activate the Page Rotary Switch in any direction to open the “FRQ” Page for Frequency Selection.



Fig 13) Open FRQ Page



Fig 14) FRQ – Frequency Selection Page

### 2.2.1 Selecting a Frequency

(1) Use the **Page** knob “←FRQ→” again to select (recall) a frequency from:

- >MEM<                four (4) memory channels
- >W<                    one (1) working (operating) frequency
- >FIX<                fixed frequencies
- >CPSAR<            seven (7) COSPAS-SARSAT channel groups

(2) The actual adjusted frequency

(3) Frequency band-information

#### Exit Frequency dialogue:

(4) Press push-button >F1< “EXIT” to exit to DF mode (using the actual frequency).

### 2.2.2 Recalling and editing frequencies from a memory channel

#### Recall:

- (1) With rotating the **Page** knob, memory channels 1 ... 4 can be selected. The >marker< symbol indicates the actual memory channel.

#### Edit:

- (2) **MHz ±** edits the MHz Value of the actual frequency.  
 (3) **kHz ±** edits the kHz Value of the actual frequency.  
 (4) **F2** switches to next band

>MHz< and >kHz< directly changes and overwrites the actual selected memory frequency inside the actual band (see also 2.2.4 Editing a Frequency).



Fig 15) Recall frequency of Memory channel 3

2.2.3 Recalling frequencies from fixed frequencies or COSPAS-SARSAT Channels

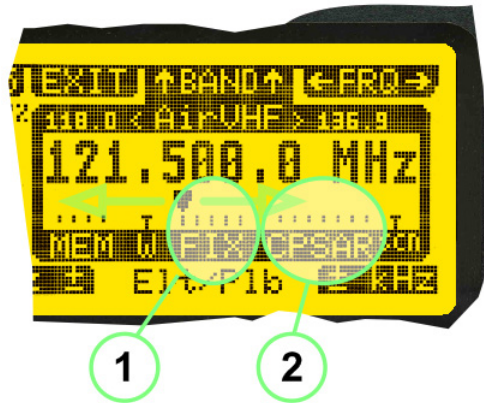

Fig 16) FRQ Selection Page with FIX1 selected

(1) "FIX" Selection range for fixed frequencies

for RT-600 **Standard** version:

- **FIX1** "Elt/Plb" **121.500 MHz**  
international VHF air distress / emergency frequency
- **FIX2** "Chnl:16" **156.800 MHz**  
marine VHF emergency radio channel 16
- **FIX3** "Elt/MIL" **243.000 MHz**  
military UHF air distress / emergency frequency

for RT-600 **Law Enforcement** version:

- **FIX1** "Elt/Plb" **121.500 MHz**  
international VHF air distress / emergency frequency
- **FIX2** "Chnl:16" **156.800 MHz**  
marine VHF emergency radio channel 16
- **FIX3** "LE(USA)" **173.xxxMHz**  
LoJack Recovery System
- **FIX4** "ETS:STD" **216.487 MHz**  
ETS standard frequency
- **FIX5** "ETS:UCV" **216.512 MHz**  
ETS u.cover frequency

(2) "CPSAR" Selection range for COSPAS-SARSAT channel groups

- **CPSAR1** "022-028" **406.022 ... 028 MHz** Channel A, B, C
- **CPSAR2** "031-037" **406.031 ... 037 MHz** Channel D, E, F
- **CPSAR3** "040-043" **406.040 ... 043 MHz** Channel G, H
- **CPSAR4** "046-052" **406.046 ... 052 MHz** Channel I, J, K
- **CPSAR5** "055-061" **406.055 ... 061 MHz** Channel L, M, N
- **CPSAR6** "064-070" **406.064 ... 070 MHz** Channel O, P, Q
- **CPSAR7** "073-076" **406.073 ... 076 MHz** Channel R, S



### 2.2.4 Editing a Frequency

While on the FRQ SELECTION Page the user can directly edit the displayed frequency.



Fig 17) FRQ Selection Page before frequency editing

- (1) **>MHz<** Rotary switch for direct adjustment of the displayed MHz range inside the actual band (1 x step = 1 MHz adjustment)
- (2) **>kHz<** Rotary switch for changing the displayed kHz frequency according to the actual band frequency grid (as example 8.333 kHz at the VHF air band).
- (3) **>F2<** Adjustment of the next available band (see next page >> Selecting a Frequency Band)

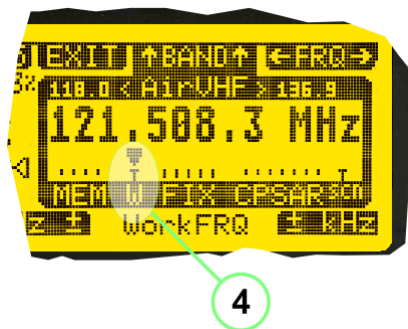

If the selected and marked frequency is not one of the MEM [1..4] channels, then the changed frequency is automatically stored in the work frequency **WorkFRQ** channel.

Fig 18) FRQ Selection Page after frequency editing

### 2.2.5 Selecting a Frequency Band

While on the FRQ Selection Page each available band can be selected by pressing **F2 BAND**.

- (1) Press push button **F2 BAND** for switch over to the next band.
- (2) **Designation** of actual selected band.
- (3) **Max. frequency limits** of the actual selected band (depends on wide band options).

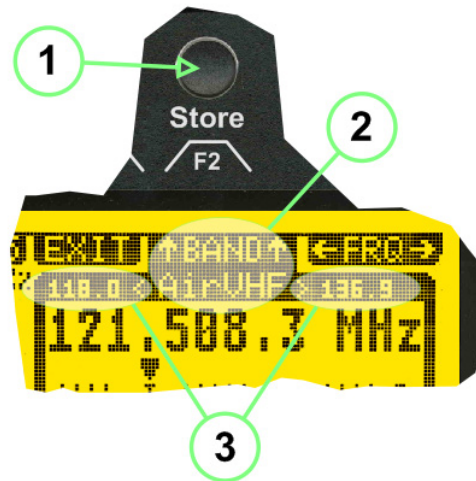

Fig 19) FRQ Selection Page (bands)

Frequency bands availability depends on the system version (A, LE) and its wide band options (F1 to F4). These optional wide bands are available if ordered in addition to the default bands.

Here is a listing of DEFAULT and OPTIONAL bands available with each version of the system.

#### RT-600 (Standard) listing of bands:

Default bands available	
Band designation	Frequency limits
VHF Emergency Band:	118.000 ... 124.000 MHz
VHF Marine Band:	154.000 ... 163.000 MHz
UHF Emergency Band:	240.000 ... 246.000 MHz
COSPAS-SARSAT:	400.000 ... 406.092 MHz
UHF FM Band:	406.100 ... 410.000 MHz

OPTIONAL extended bands available		
Option	Designation	Frequency limits
F1	VHF Air Band:	118.000 ... 136.992 MHz
F2	Extended VHF Marine:	137.000 ... 224.995 MHz
F3	UHF Air Band:	225.000 ... 399.975 MHz
F4	Additional UHF FM:	406.100 ... 470.000 MHz

#### RT-600 (Law Enforcement) listing of bands:

Default bands available	
Band designation	Frequency limits
VHF Emergency Band:	118.000 ... 124.000 MHz
VHF Marine Band:	154.000 ... 163.000 MHz
LoJack:	164.000 ... 174.000 MHz
ETS:	216.000 ... 220.000 MHz
COSPAS-SARSAT:	400.000 ... 406.092 MHz

OPTIONAL extended bands available		
Option	Designation	Frequency limits
F1	VHF Air Band:	118.000 ... 136.992 MHz
F2	Extended VHF Marine:	137.000 ... 163.000 MHz

## 2.3 Direction Finder (DF) Mode

Direction Finder (DF) mode is generally used to display all valid information processed by the DF from the signal received from a target transmitter. The amount and kind of information displayed by the DCU depends on the type and content of the signal received and processed by the DF. Simple signals such as the analog sweep-tone modulation received from a SAR beacon (ELT, PLB, EPIRB, PDD) on 121.500 MHz, allow displaying only basic bearing information; while digital signals such as COSPAS-SARSAT and LOJACK allow displaying more information, e.g. beacon IDs, GPS coordinates, codes, VLUs, etc.

### 2.3.1 Operating Elements in DF Mode

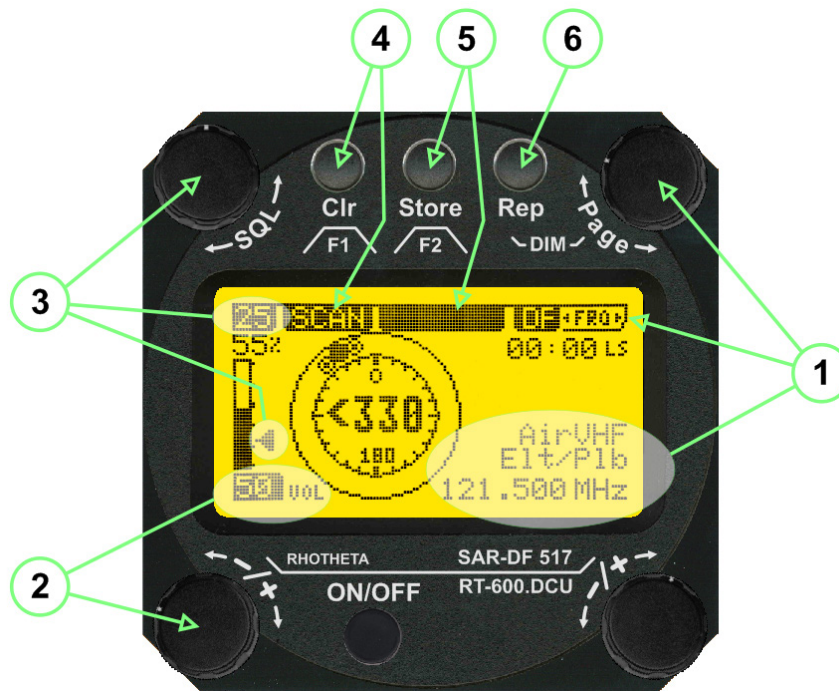

Fig 20) Operational Elements in DF Mode

This picture shows the DCU operating in DF Mode on the international emergency frequency 121.500 MHz, with an active signal being received.

- (1) **>FREQUENCY<** rotary switch activates the "FRQ" / frequency page for changing and selecting the active frequency. The last selected frequency remains stored after switching off/on the device. The selected frequency is shown on the graphic display bottom right. Above, additional information for the selected frequency is displayed. The use of the rotary switch activates a sub-page. Please refer to the Frequency Selection section for details.
- (2) **>VOLUME<** rotary switch to adjust the audio output level. The volume of a linked external speaker or amplifier can be adjusted in a range from 0 (off) to 99 (maximum loudness). The selected volume is shown in the bottom left corner of the graphic display. The volume remains stored after switching off/on the device.
- (3) **>Squelch Level<** can be adjusted by rotating the **>SQL<** switch. The squelch level has to be above the receiving level without signal (noise). Only signals above the squelch level are audible in the loudspeaker and used by the direction finder for bearing indication. The **>SQL<** rotary switch allows to select the squelch threshold, i.e. a minimum signal strength of an incoming signal to be processed. The current settings on a signal level scale from 0 % to 60 % is shown in bright letters on dark background below the SQL rotary switch and as an arrow beside the signal Strength Bar-Graph.
- (4) The **>Clr<** Push-button is used for erasing the internal bearing value averaging store and the Last Signal Timer. To activate this function, the push-button has to be hold down for a minimum of circa two seconds. The sophisticated averaging store increases bearing precision and enables at all an usable bearing display in case of bad receiving signals (if there is a far away transmitter and/or temporary complete loss of a receiving signal). Caused by the averaging procedure, a drag error may occur, which might be disturbing the

bearing indication after a quick change of course of the aircraft or vehicle. In this case, the indicated bearing value lags by the real bearing value for about two seconds (for very weak signals even longer). By pressing this push-button after a quick change of course, the display will show the new bearing value without drag error. Additionally, the **>F1/CLR<** Push-Button is used to activate specific functions high-lighted in the menu below the button by pushing it for a short time (here as example "SCAN" starts scanning the actual air band).

- (5) **>Store<** push-button: Without function except if a special function is high-lighted in the menu line of the display.
- (6) **>Rep<** push-button, when pressed and hold for min. 3 sec, the last valid bearing value with corresponding receiving level is displayed.

### 2.3.2 Standard Display in DF Mode

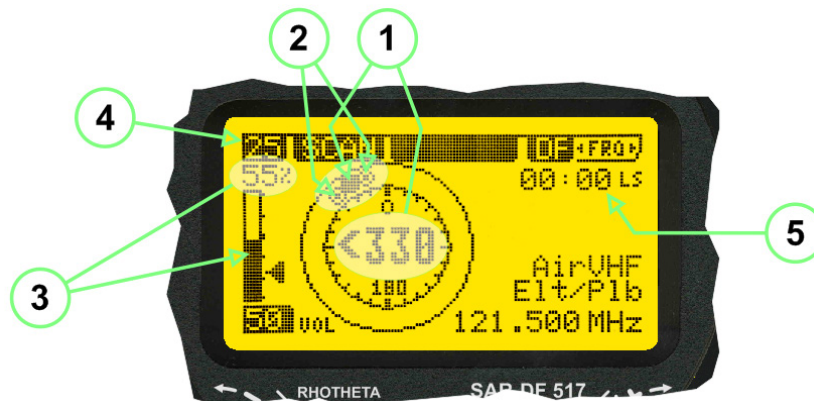

Fig 21) DF Mode

- (1) **>Relative Bearing Value<**, by means of a sophisticated averaging procedure, a steady display is accomplished, as graphic display and as text in the range of 0°... 359° (0° corresponds to bearing direct ahead).
- (2) **>Spread<** maximum deviation of un-averaged bearing values. This is an indicator of bearing quality. The wider the range between the directions of maximum deviation, the worse is the received signal. As a result of the excellent averaging procedure, even with a spread of 45°, good bearing results are achieved.
- (3) **>Receiving Level<** (field strength) of the signal as a relative percentage value, visualized as bar-graph indication and as decimal value. Even without a received signal a certain noise level may be displayed.
- (4) **>Squelch Level<** independently adjustable and stored for each frequency band. Squelch level is indicated as marker at the signal strength bar graph or as direct relative level value. A usable bearing analysis can only be achieved if the squelch level is above the noise level (without received signal). If the antenna unit is placed close a heavily disturbing electronic devices, the squelch level has to be raised, thus making the direction finder being less sensitive. In receive modes where the squelch level is set automatically, an "A" above the marker indicates the "Autosquelch" functionality.
- (5) **>Last Signal<** timer showing the time since a signal has been received for the last time (i.e. since a signal has been stronger than the squelch level). Values are "minutes : seconds".

### 2.3.3 Special Options in COSPAS-SARSAT DF Mode

Especially for the use together with beacons transmitting a data signal according to COSPAS-SARSAT specifications in the 406-MHz-Band, special functionalities and pages are being provided.

After selection of a COSPAS-SARSAT Frequency (refer to the chapter "Frequency selection Page"), the bearing page provides additional information and operating options.

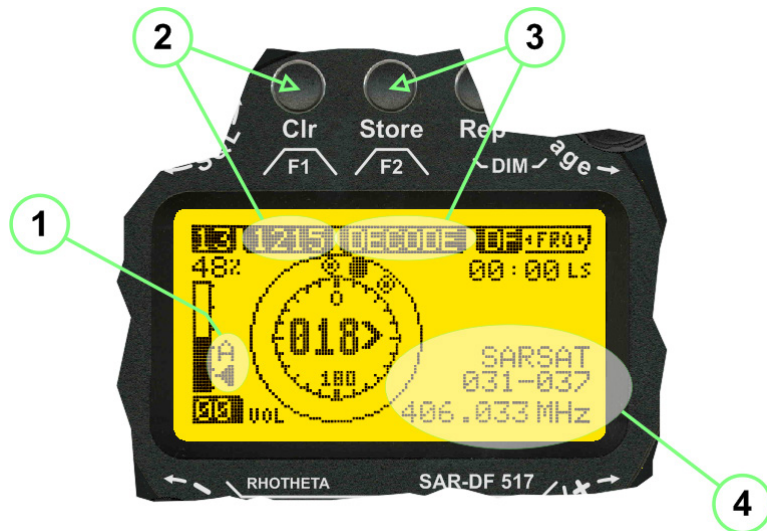

Fig 22) Operational Elements and Display in COSPAS-SARSAT DF Mode

- (1) **>Auto Squelch<** indication that the squelch level is set automatically to be close to the noise floor. It is recommended to use the Auto Squelch always during COSPAS-SARSAT operation. This can be achieved by manual selecting 0 % (lowest possible value) or 60 % (highest possible value) as squelch level. During COSPAS-SARSAT-operation, this will force the automatic adjustment of the squelch level.
- (2) **>121.500<** menu option. The COSPAS-SARSAT signal in the 406 MHz band is transmitted only every 50 seconds in form of a short data burst of 440 or 520 ms. Approaching the transmitter, it will be received earlier than the 121.500 MHz continuous signal due to its high transmitter power. However, at a closer distance to a transmitter, the bearing on 121.500 MHz is faster thanks to the continuous or rapidly intermittent signal. The 121.500 MHz menu option allows a direct switch-over to 121.500 MHz. Direct return back from 121.500 to the COSPAS-SARSAT band is possible from the 121.500 MHz bearing window in COSPAS-SARSAT mode. Please refer to the chapter 2.3.5 for details.
- (3) **>Decode<** menu option. Allows to open the COSPAS-SARSAT Decode sub-page by shortly pushing the F2 push-button above the menu option.
- (4) **>Frequency Range<** indication. COSPAS-SARSAT is using a channel spacing of 3 kHz for its beacons. Due to the internal architecture of the direction finder, it is possible to receive more than one channel in the same time. Thus, frequency steps of the direction finder are 8.33 kHz instead of 3 kHz. The receive frequency covered by the current receive frequency setting is shown in the display line above the receive frequency indication.

#### Note

If the exact frequency of the COSPAS-SARSAT beacon is unknown, it is strongly recommended to use the COSPAS-SARSAT scanning functionality in order to detect the correct frequency (refer to the chapter "Frequency (FRQ) Selection Page" & "COSPAS-SARSAT Scan Mode").

### 2.3.4 COSPAS-SARSAT Decode Window

The COSPAS-SARSAT Decode Window allows decoding incoming COSPAS-SARSAT data messages.

Only while this decode window is activated, the decoding is possible. An already received COSPAS-SARSAT pulse, while DF bearing mode was activated, cannot be used for decoding afterwards. In this case the user has to wait, while this decode window is active, for the next transmitted pulse (approx. 50 sec later).

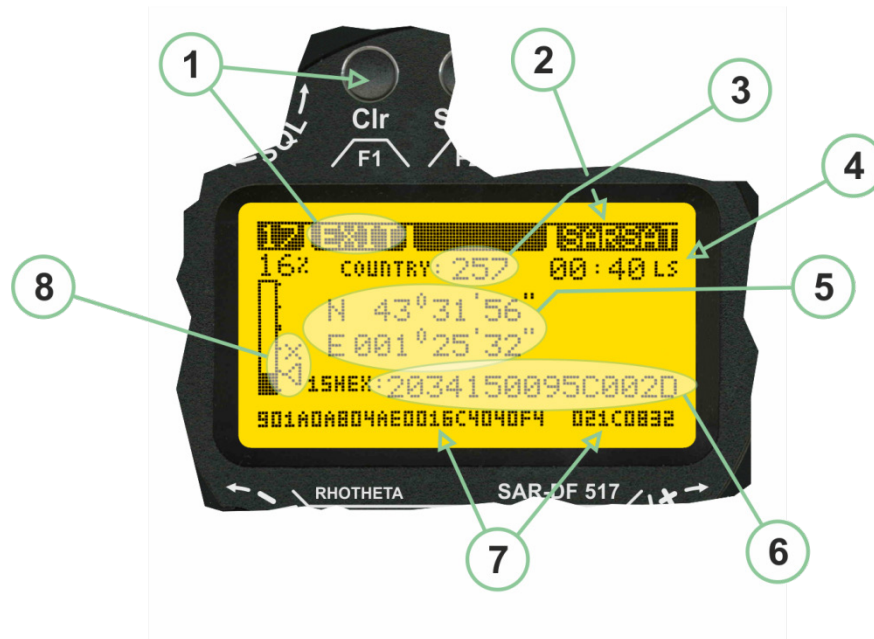

Fig 23) COSPAS-SARSAT Beacon Information Page

- (1) **>EXIT<** push button (F1 button) allows to exit the decode window and switch back to the COSPAS-SARSAT DF Mode page.
- (2) **>SARSAT<** in the upper right corner of the display indicates that the COSPAS-SARSAT decode function is activated.
- (3) **>Country<** displays the COSPAS-SARSAT Country Code coded into the received data message.
- (4) **>Last Signal<** time since the last COSPAS-SARSAT message has been received in “minutes : seconds” format.
- (5) **>Position<** field showing. In case of location protocols being used by the beacon, the encoded GNSS position data (latitude / longitude) transmitted by the beacon.
- (6) **>15-HEX-ID<** 15-HEX-ID of the beacon in hexadecimal format.
- (7) **>Data string<** of the bits 25 to 112 of the COSPAS-SARSAT data burst in case of short messages, and bits 25 to 144 in case of a long message format. The last 8 Hex Values are separated by a blank. Bit- and Frame-synchronization hex values (Bits 1 to 24) are suppressed to increase the readability of the data message.
- (8) **>X<** sign to indicate that the Squelch is controlled by the antenna unit for optimum sensitivity. The user has no access to the Squelch setting.

### 2.3.5 Tracking 121.500 MHz while in COSPAS-SARSAT Mode

While in COSPAS-SARSAT DF Mode the user can switch to 121.500 MHz in order to track the beacon in VHF. If a valid signal is not received in 121.500 MHz the user can switch back to the last active COSPAS-SARSAT channel (406 MHz frequency) being tracking previously.

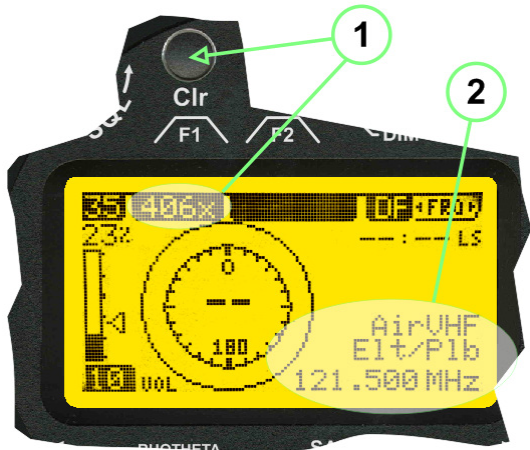

Fig 24) Tracking 121.500 MHz while in COSPAS-SARSAT Mode

Differences are:

- (1) >406x< press **F1** to switch back to the last COSPAS-SARSAT channel (406 MHz frequency) being tracking previously
- (2) >121.500 MHz< Actual frequency being tracked

### 2.3.6 COSPAS-SARSAT Scan Mode

If the COSPAS-SARSAT Scan Mode has been selected at the frequency selection page “FRQ”, the COSPAS-SARSAT channels, as selectable manually from the Frequency Selection Page, are scanned. After reception of a COSPAS-SARSAT signal, the scanning is stopped at the received frequency.

Due to the fast scanning – the complete COSPAS-SARSAT sub-band is scanned within less than 400 ms – detection of a receivable COSPAS-SARSAT signal is possible within one COSPAS-SARSAT repetition cycle.



Fig 25) FRQ Selection Page with SCN COSPAS-SARSAT Scan Page selected

At the frequency selection page an active COSPAS SARSAT scanning can be stopped by de-activating it with the rotary button (1).

While the scanning is active it is also possible to switch back to the DF page by pressing >F1< “EXIT”.



Fig 26) DF page with active COSPAS-SARSAT Scan Mode at the DF page

- (1) >SCAN< flashing indication notifying the user that the equipment is operating in scan mode.
  - (2) **Frequency** display indicating the COSPAS-SARSAT scanning frequency range.
  - (3) >X< sign showing that squelch settings are controlled autonomously by the receiver.
- Scan mode can be left by pressing >F1< “STOP”.

### 2.3.7 Marine Ship Scan Mode

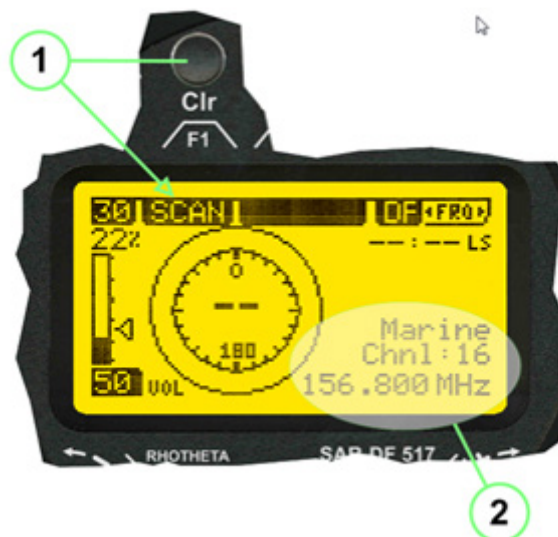

Fig 27) DF Mode, FRQ = 156.800 MHz, F1 for scan function

If the active frequency (2) is within the VHF Marine Band, a fast scan of all ship channels is possible by pushing >F1< “SCAN (1). In this scanning mode all marine channels 1 to 88 (156.025 to 157.450 MHz) are scanned continuously until a signal is received. To offer the best monitoring functionality for the user also signals between two channels (4) are detected (scanning without gap).

In order to prevent the scan to stop on noisy frequencies, it is recommended to start scanning with high squelch settings. You can reduce the squelch level in steps until the scan stops on a noisy frequency for the first time. Then increase the squelch level slightly. This will result in the highest possible scan sensitivity and avoiding noisy channels due to RF disturbances, sometimes generated by other equipment in own aircraft.



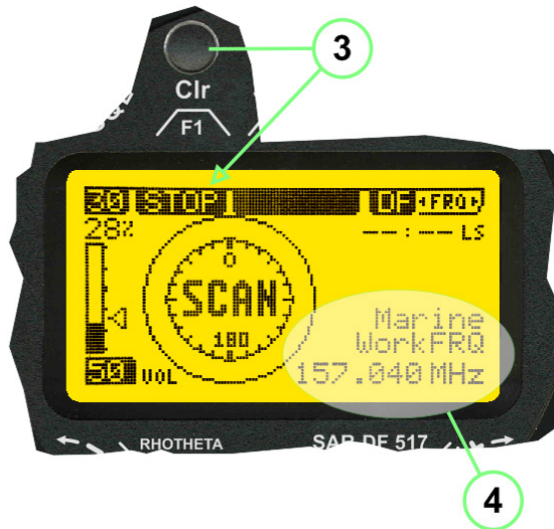

Fig 28) DF Mode, active scanning in process

The scanning is stopped by pressing >F1< "STOP" (3).

## 2.4 Law Enforcement Operation

Law enforcement, special ops, and other organizations use the RT-600 LE (LAW ENFORCEMENT) version instead of the RT-600 A (STANDARD) version. One of the reasons is that the LE version features scanning and tracking of signals like LoJack and ETS, as well as signals in the 216.000 MHz – 220.000 MHz band such as medical beacons, wrist/ankle transmitters, cash/asset recovery “tags” etc.

However the LE version shares many functions in common with the A version such as scanning and tracking in the AIR band, COSPAS-SARSAT band, etc.

### 2.4.1 Power-On Procedure

The power-on procedure is the same as described in 2.1.2

- (1) System Version: “(L)” for LAW ENFORCEMENT version.



Fig 29) STARTUP Screen (see 2.1.2 for details)

### 2.4.2 LoJack Scan Mode for a VLU Code

For the convenience of Law Enforcement and other special ops users who frequently engage in tracking **SVRS (Stolen Vehicle Recovery System)** signals such as **LoJack (LoJack Corp, FCC 90.20 Part 2 SVRS)**, RHOTHETA has optimized the power-on procedure of the RT-600 LE version so that right after the STARTUP screen the unit displays automatically the **LoJack Scan Mode** page to start immediately scanning for a valid **VLU (Vehicle Location Unit)** code without pressing any key.

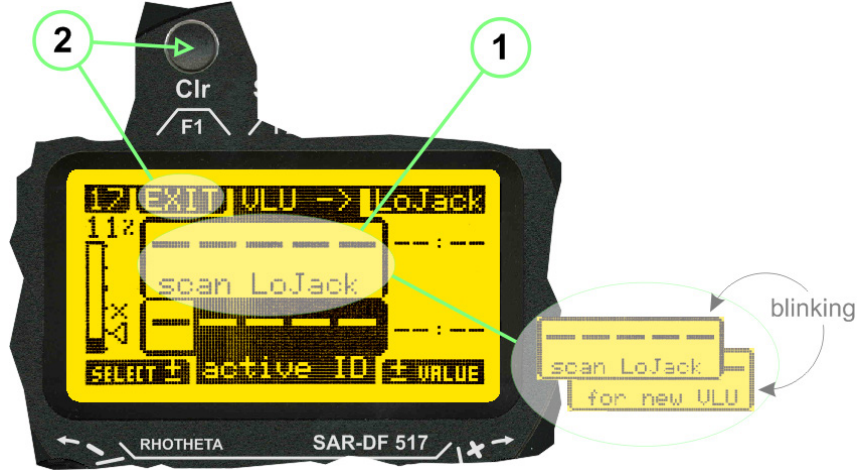

Fig 30) LoJack Scan Mode, unit is scanning for a LoJack VLU Code

- (1) >Scan LoJack< DF is scanning for any new LoJack VLU Code.
- (2) >EXIT< press F1 to exit and switch directly to DF Mode.

### 2.4.3 LoJack Scan Mode from any other page

While operating on any page other than the LoJack Scan page, the user can switch directly to LoJack Scan Mode by pressing Hotkey **F2** for 2 secs.

- (1) Press Hotkey **F2** for 2 secs to switch to the LoJack Scan page.



Fig 31) Hotkey F2

#### 2.4.4 Manual activation of LoJack Scan Mode

- (1) Select the LoJack frequency (see also Frequency Selection Page).
- (2) Press **F1** to switch back to the DF MODE.



Fig 32) FRQ Selection Page, FRQ = LoJack, BAND = LoJack (164-174 MHz)

While in DF MODE with adjusted LoJack frequency, the user can switch directly to the LoJack Scan by pressing **>F1< "SCAN"**.

- (1) Press **F1 SCAN** to switch to the LoJack Scan page.
- (2) Still no LoJack ID filter used (ID=off) → all transmissions are received on the active frequency, as example also unwanted tower pulses.



Fig 33) DF Mode with LoJack filter OFF

### 2.4.5 Receiving and accepting a new VLU Code

In LoJack Scan Mode the VLU codes are received. If a new VLU code is displayed the user can accept it and switch directly to DF Mode by pressing **F2**.

- (1) A new LoJack VLU Code (**0001A**) has been received.
- (2) Press **F2** to accept the new VLU Code (**0001A**) and switch to **DF MODE** page with the LoJack filter activated to track only 0001A.



Fig 34) LoJack Scan Mode with new VLU Code received

### 2.4.6 Entering a new VLU Code manually

While in LoJack Scan Mode, the user can enter a LoJack VLU code also manually.

- (1, 2, 3) Use the **SELECT±** and **±VALUE** knobs to enter a new LoJack VLU Code / active ID (0001A).
- (4) Press **F1** to accept the new VLU Code and switch to DF Mode with the LoJack filter ON to track only 0001A.



Fig 35) LoJack Scan Mode with new VLU Code entered manually

### 2.4.7 Tracking one VLU Code while monitoring new VLU Codes

While on DF Mode and tracking a VLU Code (**0001A**) the user can turn the LoJack switch OFF with **F2**, also the user can start scanning all VLUs again with **F1**.

- 0001A is displayed as the active VLU Code, filter function is **ON**, only 0001A is tracked.
- Monitoring of other VLU Codes is active in the background.

- (1) Press **F1** to switch to the LoJack Scan Mode, to scan for new VLU Codes.
- (2) Press **F2** to switch LoJack filter **OFF**.

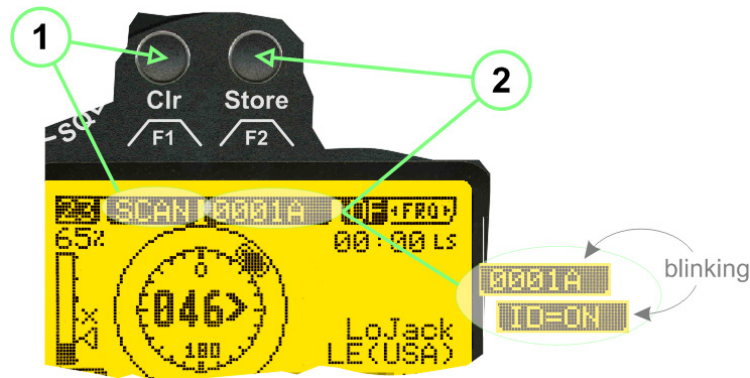

Fig 36) DF Mode with active VLU Code and LoJack filter ON

### 2.4.8 Tracking one VLU Code and receiving a new VLU Code

While on DF MODE page and tracking VLU Code (**0001A**), in the background a new VLU Code is received and decoded (**G2HC7**):

- (1) The new VLU Code is announced (**\*NEW\* G2HC7**).
- (2) Press F1 to switch to LoJack Scan Mode to see the arrival time of G2HC7 and the possibility to change bearing to this new G2HC7.

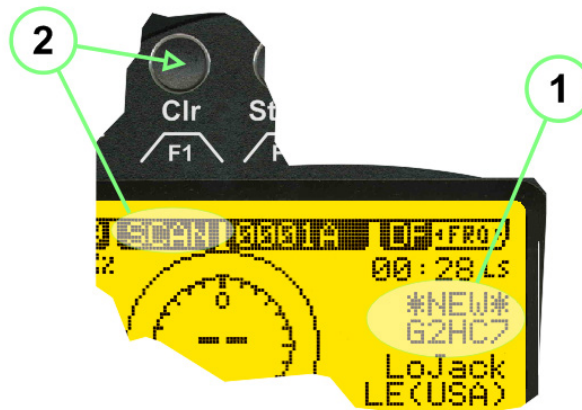

Fig 37) DF Mode with active VLU Code and announcement of new VLU Code

**2.4.9 Switching to a new VLU Code**

While on the LoJack Scan Page, tracking one VLU Code (**0001A**) and notified of a new VLU Code (**G2HC7**):

- (1) Press **F1** to continue tracking **0001A**.
- (2) Press **F2** to start tracking **G2HC7**.
- (3) Time elapsed since G2HC7 was last received.
- (4) Time elapsed since 0001A was last received.

If **F1** is pressed for 2 sec, the indicated VLU Code (G2HC7) and ID (0001A) are deleted.



Fig 38) LoJack Scan Page with one active VLU Code and one new VLU Code

**2.4.10 “Blocking” function of one LoJack VLU Code**

The LoJack scan page can also be used to “block” one unwanted LoJack VLU / ID signal by separating the adjusted active ID from any other received LoJack VLU signal. This is done by muting the audio (see example below), when a LoJack signal with VLU code “0001A” is received.

Any new VLU Code (active LoJack signal) - except for 0001A – will be displayed on the top row and generate the audible beep tone.



Fig 39) LoJack Scan Page with one active VLU Code and audio OFF

**Note**

“Blocking” is an important tool for practical missions. As example, a stolen vehicle with VLU / ID “0001A” was tracked in the DF bearing mode. The mission is completed, but the VLU is normally still transmitting. With the settings above, only new VLU signals except the now unwanted “0001A” are audible and displayed in the upper (scan LoJack ... for new VLU) box.

### 2.4.11 Tracking in the 216 to 220 MHz band

The RT-600 LE features scanning and bearing functionality in the 216.000 MHz to 220.000 MHz band.

The 216.000 MHz – 220.000 MHz band contains frequencies and signals used by special services, and tracked by law enforcement, special ops, and similar organizations. These are some of the frequencies and services in this band:

- CFR 90.259 tx: 216.000 MHz to 220.000 MHz
- Low Power Radio Service (LPRS) tx: 216.000 MHz to 217.000 MHz
- Medical beacons, Project Lifesaver tx, wrist/ankle tx: 213.000 MHz to 216.000 MHz
- ETS tx, stolen cash/asset recovery tx, “bait”/“tag” tx: 216.000 MHz to 220.000 MHz

tx = transmitter(s)

However any future or current user of the RHOTHETA RT-600 must be aware that tracking signals on the frequencies listed above may be challenging and even frustrating, due mostly to negative factors in some of the transmitters:

- Very low RF power output
- Inefficient antennas
- Battery-powered devices with a “low battery” condition
- Devices worn or located in conditions of poor RF propagation
- Devices with channel spacing different than the one specified for the RT-600

These factors can make it very difficult for the DF to receive the signal and/or display an accurate bearing.

#### **Disclaimer:**

For the reasons explained above, and even though the RT-600 features top performance in its class, RHOTHETA does not offer - and is not to be held responsible for - any guaranteed minimum range or distance to a transmitter in this band.



## 2.5 Setup Edit Page

System settings are displayed in the setup page. The functions described in this section should be used by trained personal only.

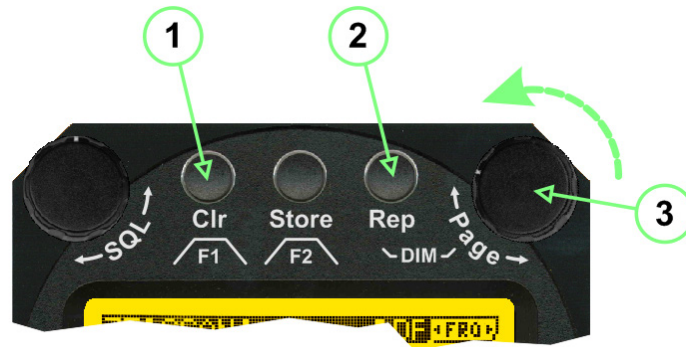

Fig 40) Accessing the Setup Page

The setup page can be accessed by holding down the **>Clr<** (1) and **>Rep<** (2) buttons simultaneously and, in the same time, performing a left-hand turn on the **>Page<** rotary switch (3).

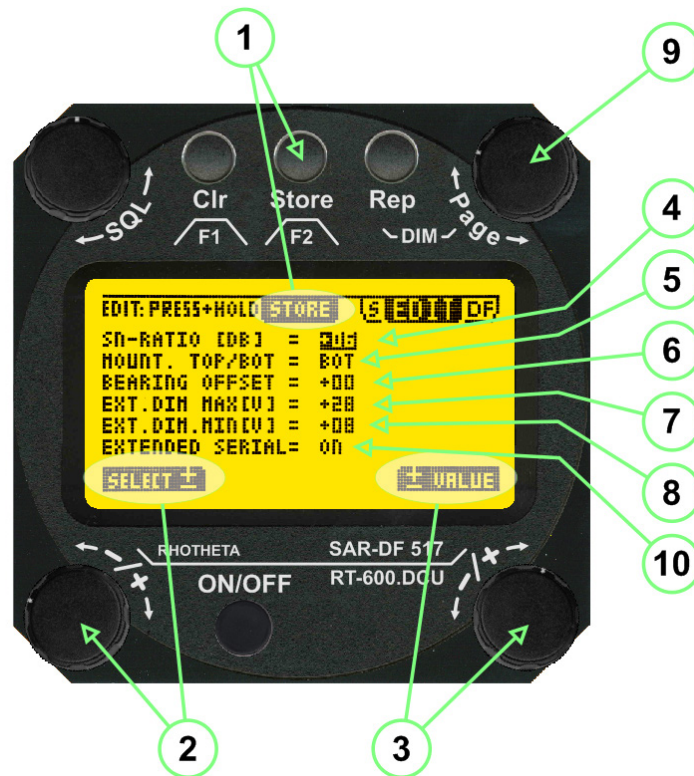

Fig 41) Setup Page

- (1) **>Store<** push-button must be pressed in parallel if a value of a setting shall be modified. If a value can be modified, the background stops to blink.
- (2) **>Select<** rotary switch used to scroll through the menu options. The value of the actually activated menu option is high-lighted with dark background and blinking.
- (3) **>Value<** rotary switch used to change values in menu options (**>Store<** (1) has to be pressed in parallel if a value shall be modified).

- (4) **>SN-Ratio<** menu option representing the necessary Signal-To-Noise-Ratio (Difference between signal and noise level) used as criterion for the automatic squelch function. Please refer to the chapter “Squelch Operation” for details. Default value is 6.0 dB.
- (5) **>Mounting Position<** menu option to select top or bottom mounting of the DF antenna. In case of rooftop installation (e.g. on land vehicles), “**Top**” shall be selected. In case of bottom-down (upside-down) installation (e.g. on a helicopter), “**Bot**” shall be selected. If this option is not selected correctly, all bearing values will be mirror-inverted.
- (6) **>Bearing Offset<** menu option to include a constant offset correction to the bearing indication. Bearing values in degrees will be changed according to the offset value.
- (7) **>Maximum External Dimming Voltage for Legends<** menu option which sets the upper limit of the dimming input voltage for the legends-panel. Range = [1.5 ... 28] V
- (8) **>Minimum External Dimming Voltage for Legends<** menu option which sets the lower limit of the dimming input voltage for the legends-panel. Range = [1.5 ... 28] V
- (9) **>Page<** rotary switch to be turned right-hand to go back to the Direction Finder page. A left-hand turn on this rotary switch will show up an additional service page with debug information used for system checks.
- (10) **>Extended Serial<** It is possible to enable or disable the extended serial data protocol. Only of interest, if serial data is used by any connected control units like moving maps or computers. For detailed information see Serial interface data protocol (short description) on page 48. If there are compatibility problems with already existing older remote control software, it is recommended to switch OFF the extended serial data protocol.

### 3 Error messages

If an internal error of the device is recognized, a corresponding, flashing error message will be shown in the DF pages:

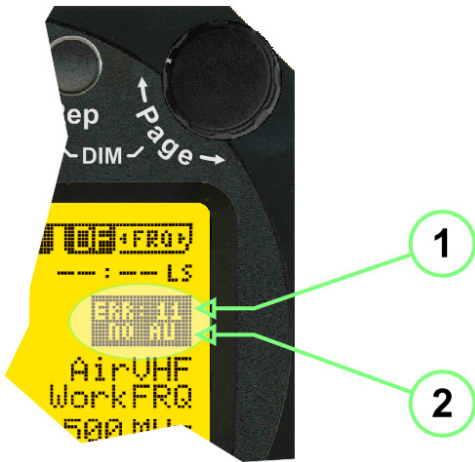

Fig 42) Error Messages

- (1) **Error message** including **error code** (in brackets).
- (2) **Short description** of the indicated error.

In case of coincidence of various errors, the error with the highest priority will be displayed.

Error Messages		
Error Message	Error Location	Reason
<b>ERR: 12 VOLT.DU</b>	Main voltage supply	Main Voltage input too low ( $\leq 10.0$ V)
<b>ERR: 11 NO AU</b>	Connection: antenna $\rightarrow$ display or Antenna Unit	No serial data (RS485) from Antenna Unit. No or damaged connection between antenna and display, or damaged antenna unit.
<b>ERR: 10 BAD AU</b>	Connection: antenna $\rightarrow$ display	Incompatibility or bad data connection between display and antenna
<b>ERR: 9 BAD RU</b>	Remote Unit	Incompatibility or bad data connection between display and external serial Remote Unit or PC
<b>ERR: 8 VOLT.AU</b>	Antenna Unit	Voltage supply at Antenna Unit too low ( $\leq 9.0$ V). Main voltage supply too low or considerable drop of voltage between display and antenna.
<b>ERR: 7 BAD DCU</b>	Connection: Display $\rightarrow$ Antenna	Incompatibility or bad data connection between antenna and display
<b>ERR: 6 NO DCU</b>	Connection: Display $\rightarrow$ Antenna	No serial data from Display Control Unit to Antenna Unit
<b>ERR: 5 PLL ERR</b>	Antenna	Error in synthesizer-oscillator of receiver in Antenna Unit.
<b>ERR: 4 FRQ+OFS</b>	Received transmitter	Received frequency too high (more than 6 KHz / error of transmitter)
<b>ERR: 3 FRQ-OFS</b>	Received transmitter	Received frequency too low (more than 6 KHz / error of transmitter)
<b>ERR: 2 DECODE</b>	Radio distance: transmitter $\leftrightarrow$ DF	Data Bits of decoded signal (COSPAS-SARSAT or LoJack) defective
<b>ERR: 1 DATARNG</b>	Incompatibility of: data DCU $\leftrightarrow$ AU	Protocol data bytes out of valid range
<b>ERR: 0 NO REC</b>	Antenna Unit: receiver	Receiver board defective

## 4 Installation

### 4.1 Antenna Unit

A convenient position of the monopole bearing antenna is crucial for good bearing results. The antenna needs an effective ground connection to the body of the aircraft or to the roof of the vehicle. If there is no metallic mounting surface available, a metallic sheet or similar (net) with connection to ground has to be applied first between vehicle-body and antenna.

In this hatched area, the antenna touches the body of the vehicle/aircraft. In order to obtain a good ground connection, the surface of the body should be bared. (Measuring unit [mm])

8 x holes for mounting the antenna unit to the vehicle / aircraft.

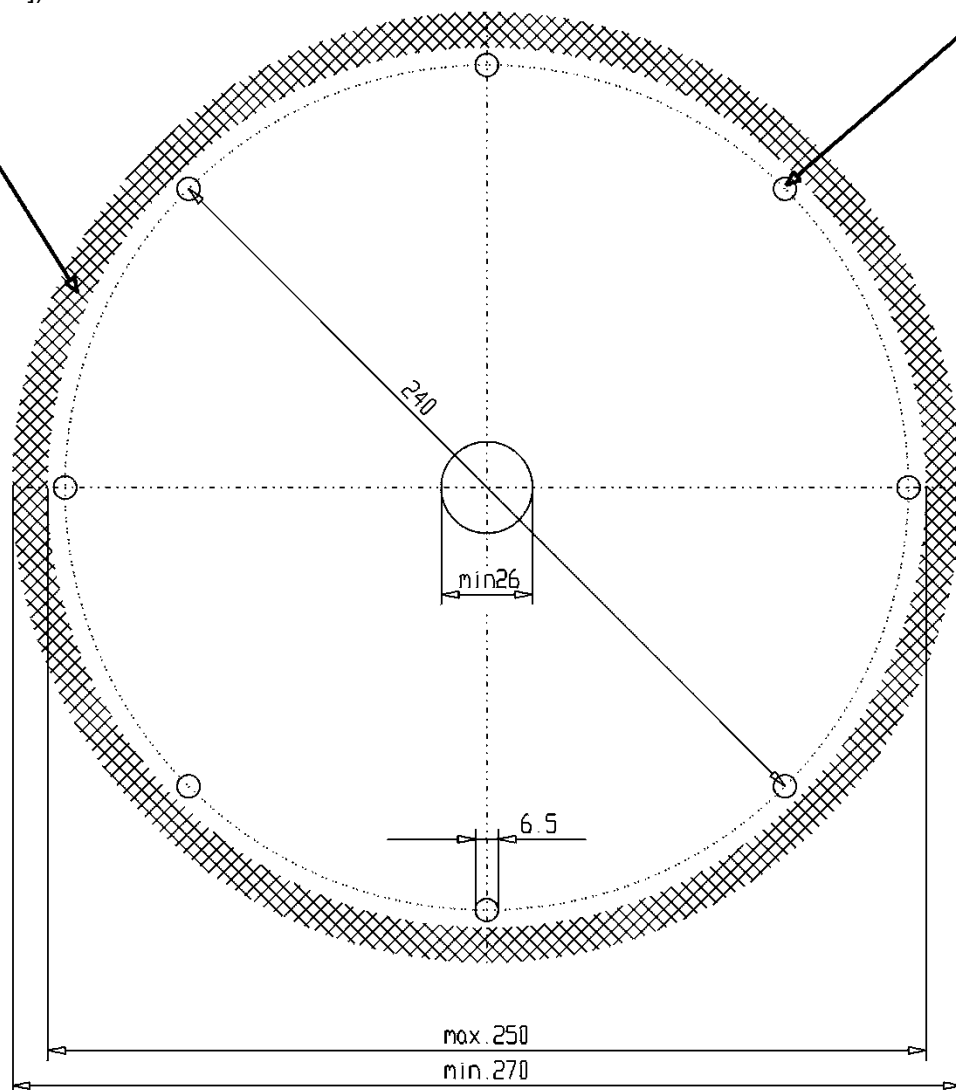

Fig 43) Antenna Mounting Drawing

#### 4.1.1 Influence of antenna location and environment on the bearing accuracy

##### Recommendations concerning the practical antenna unit location on helicopters and airplanes:

The bearing accuracy of the direction finder antenna unit is severely influenced (comparable to an airspeed sensor) by the environment. For comparison, a perfect high quality speed sensor will not indicate the true airspeed if this sensor is interfered by strong turbulences.

The direction finder antenna unit acts as a sensor for electromagnetic waves. In the near field of this antenna unit, any conductive (e.g. metallic) obstacle will influence the incoming wave field and create reflections which decrease the bearing accuracy. These are general physical limitations concerning all types of direction finder systems.

To achieve the best bearing results, it should be considered that the antenna unit is installed as far away as possible from any other vertically polarized conductive structure. If possible, there should be no reflectors within an area of 2-3 feet around the antenna unit.

In this worst case example the direction finder will not work properly.



Fig 44) Antenna installed in a bad location

In this example, the antenna unit is located too close to the cable cutter of the helicopter. This cutter will produce strong reflections, especially as the length is equal to  $\lambda/4$  within the VHF air band.

Examples of properly installed direction finder antenna units.



Fig 45) Antenna installed in good locations

## 4.2 Display and Control Unit

The display control unit may be mounted into a front panel by the means of this mounting drawing:

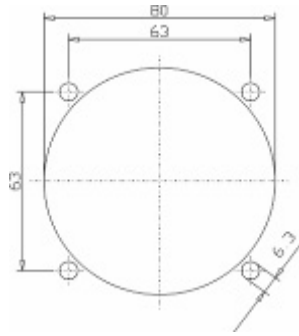
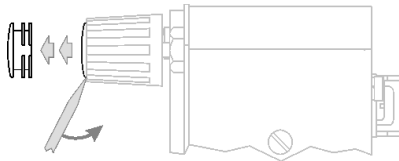

Fig 46) DCU Mounting Drawing, all dimensions in [mm]

To install or uninstall the display control unit, perform the following steps:

**(1) Remove the cover caps of the four rotary switches:**



- (2) Loosen the screws visible below the position of the cover caps.
- (3) Remove the plastic button from the axis of the four rotary switches.
- (4) Mount / dismount the Display Control Unit.
- (5) Re-install the plastic buttons on the axis of the four rotary switches.
- (6) Fix the screws so that the plastic buttons are fixed on the axis.
- (7) Re-install the cover caps on the four rotary switches.

### 4.3 System Interconnect Wiring Diagram

(Also refer to chapter “Technical Data” for details)

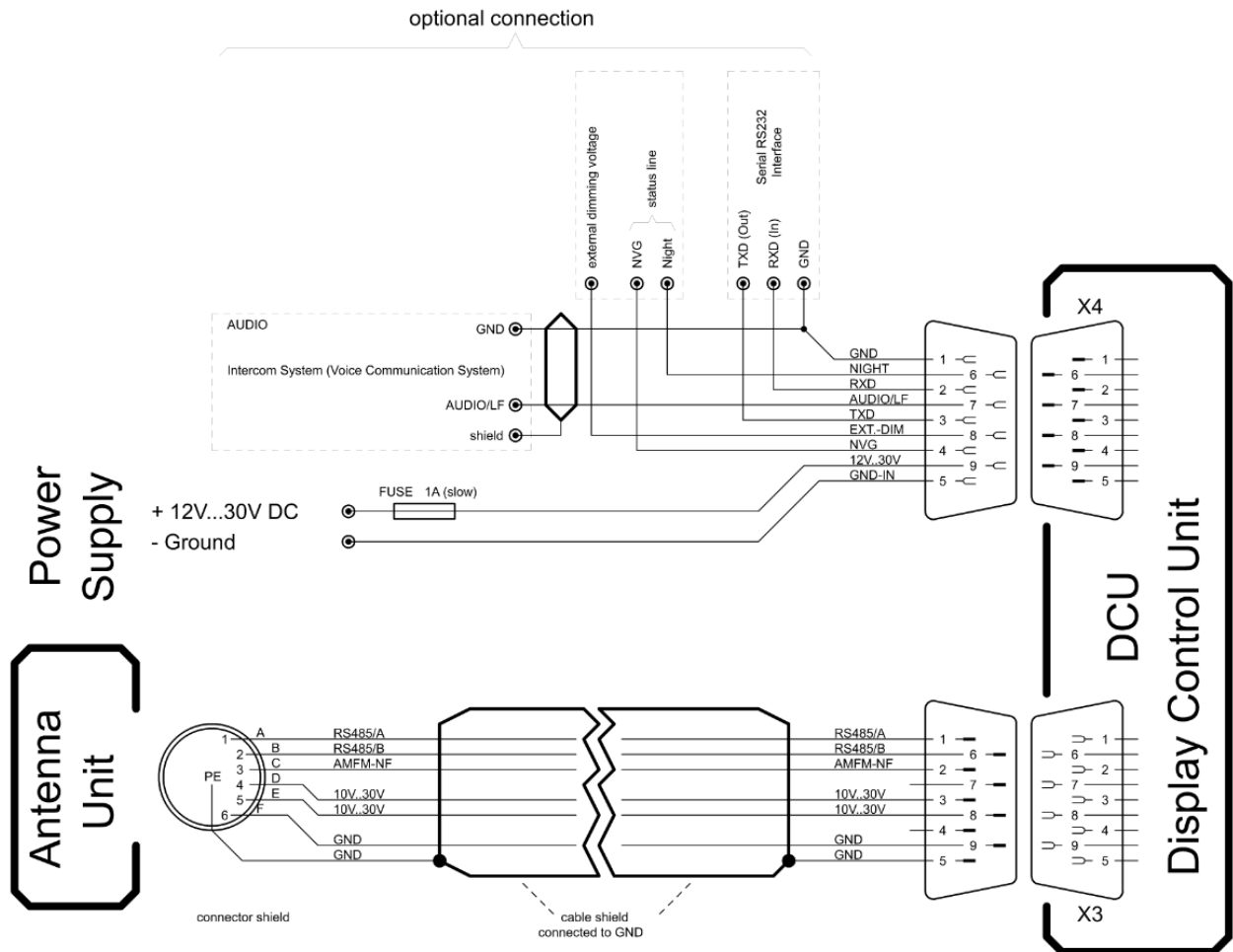

Fig 47) System Interconnect Wiring Diagram

6-pol. Amphenol plug, female  
X-K-1000

max. length of cable 20 m

9-pol. Sub-D plug  
(female / male)  
X-1009 / X-1008



## 5 Technical Data

### 5.1 Electric Features

Method of bearing:	Doppler (3 kHz rotation frequency)		
Bearing accuracy <sup>1</sup> :	≤ 5° RMS		
Internal system resolution:	1°		
Bearing sensitivity <sup>2</sup> :	VHF Air Band:	≤ 6 μV/m	(4 μV/m typical)
	VHF Marine Band:	≤ 5 μV/m	(2.5 μV/m typical)
	LoJack:	≤ 5 μV/m	(2 μV/m typical)
	UHF Emergency, ETS:	≤ 6 μV/m	(4 μV/m typical)
	Complete UHF Air Band:	≤ 10 μV/m	(6 μV/m typical)
	COSPAS-SARSAT:	≤ 15 μV/m	(8 μV/m typical)
	UHF FM Band:	≤ 15 μV/m	(6 μV/m typical)
Frequency stability:	± 2.0 ppm		
Reception frequencies, RT-600 A SAR version <sup>3</sup> :	VHF Emergency Band: 118.000 to 124.000 MHz (8.33 kHz steps, AM)		
	VHF Marine Band: 154.000 to 163.000 MHz (5 kHz steps, FM) (channel 16 selectable via channel no.)		
	UHF Emergency Band: 240.000 to 246.000 MHz (25 kHz steps, AM)		
	UHF FM Band: 406.100 to 410.000 MHz (5 kHz steps, FM)		
	COSPAS-SARSAT: 400.000 to 406.092 MHz (8.33 kHz steps, PSK) Incl. 406.022 to 406.076 MHz (Channel A .. S)		
Frequency options:	F1: VHF Air Band:	118.000 to 136.992 MHz	
	F2: extended VHF Marine Band:	137.000 to 224.995 MHz	
	F3: extended UHF Air Band:	225.000 to 399.975 MHz	
	F4: additional UHF FM Band:	406.100 to 470.000 MHz	
Reception frequencies, RT-600 L LAW Enforcement version <sup>3</sup> :	VHF Emergency Band: 118.000 to 124.000 MHz (8.33 kHz steps, AM)		
	VHF Marine Band: 154.000 to 163.000 MHz (5 kHz steps, FM) (channel 16 selectable via channel no.)		
	LoJack:	164.000 to 174.000 MHz (12.5 kHz steps, AFSK)	
	ETS:	216.000 to 220.000 MHz (10/12.5 kHz, AM)	
	COSPAS-SARSAT:	400.000 to 406.092 MHz (8.33 kHz steps, PSK) Incl. 406.022 to 406.076 MHz (Channel A .. S)	
Frequency options:	F1: VHF Air Band:	118.000 to 136.992 MHz	
	F2: extended VHF Marine Band:	137.000 to 163.000 MHz	
COSPAS-SARSAT	Full automatic detection of any active COSPAS-SARSAT channel A to S		

<sup>1</sup> Measured with unmodulated, undisturbed wave field, field strength ≥ 20 dB above sensitivity level by changing the angle of incidence with antenna rotating on a revolving table in order to eliminate environmental influences on the results.

<sup>2</sup> ±5° bearing fluctuation

<sup>3</sup> Frequency range (lowest and highest tunable frequency) depends on the software configuration (unlock options).

fast scan mode:	within 400 ms	
COSPAS-SARSAT decoding:	Reception and decoding of COSPAS-SARSAT data signals (data formats, according to specification COSPAS-SARSAT C/S T.001).	
LoJack decoding:	Choosing a LoJack transmitter by selecting the LoJack identification code	
Special scanning modes:	Complete maritime ship band scanning within 5 s	
Bearable modulation types:	AM / FM voice (A3E, F3E), ELT modulation (A3X), PSK, AFSK, FSK, ASK These types of modulation do not affect bearing quality.	
Polarization:	Vertical	
Polarization error:	$\leq 5^\circ$ at $60^\circ$ field vector rotation	
Cone of silence:	$30^\circ$ (additional bearing error $\leq 5^\circ$ )	
Response time <sup>4</sup> :	$\leq 50$ ms	
LC-graphic display	Resolution 128 x 64 pixel, background light, adjustable dimming	
NVG cockpit design:	Fully compatible NVIS Green B display Control Unit (optional)	
Operating voltage:	27.5 V nominal (Input voltage range 12 V DC to 35 V DC)	
Current consumption:	LCD-background light Off:	500 mA at 12 V DC 250 mA at 24 V DC
	LCD-background light 100 %:	750 mA at 12 V DC 350 mA at 24 V DC
	Option NVG, LCD-background light 100 %:	900 mA at 12 V DC 400 mA at 24 V DC
	RT-600 Light (AU only):	200 mA at 12 V DC 100 mA at 24 V DC
Audio out:	AC coupled speaker 2 W (4 $\Omega$ ) Maximum output voltage 8 V <sub>PP</sub> at maximum volume	
Interface:	Remote control / indication:	Serial interface RS-232 (9600 baud, 8 data bits, 1 stop bit, no parity) ARINC 429 low/high speed (optional)
	Input for dimming of legends:	Analog, 1.5 to 28 V
	Night status line:	Discrete, low-active
	NVG status line:	Discrete, low-active

## 5.2 Interface

External connections (optional / at Sub-D 9-pol. Male connector)

### Dimming:

Pin 8	External voltage	Analog input signal for variable control of the legends illumination.
-------	------------------	---

<sup>4</sup> Measured with field strength  $\geq 20$  dB above sensitivity level. Signals below this level can increase the response time.

	input for variable dimming of legends (optional)	Input voltage range is freely adjustable in the range of 1.5 ... 28 V in the setup menu. Refer to chapter "Setup Page". Default setting 8 ... 28 V (8 V = Off, 28 V = max. dimming for legends). Input Impedance: > 50 k $\Omega$
Pin 6	Night status line for LCD dimming (optional)	Low-active (as example switch to ground). At input voltage < 2.5 V <sub>DC</sub> the LCD dimming operates in night/NVG mode. Maximum brightness ca. 4% of day/default mode brightness. Input Impedance: > 50 k $\Omega$
Pin 4	NVG status line for LCD dimming (optional)	Same function as the pin 6. Low-active (as example switch to ground). At input voltage < 2.5 V <sub>DC</sub> the LCD dimming operates in night/NVG mode. Maximum brightness ca. 4% of day/default mode brightness. Input Impedance: > 50 k $\Omega$

**Audio/LF:**

Pin 7	Audio output signal	AC coupled voltage source with very low inner resistance. Maximum output voltage ca. 8 V <sub>PP</sub> = 2,83V <sub>RMS</sub> at maximum volume. Maximum output power ca. 2 W with 4 $\Omega$ speaker. If a headphone is connected ([32...600] $\Omega$ / 100mW), we recommend using a resistor (18 $\Omega$ / 0.25 W) between audio output and headphone to prevent damage of the headphone.
-------	---------------------	--

**Serial interface RS232:** 9600 baud, 8 data bits, 1 stop bit, no parity

Pin 3	TXD	Serial output (ca. $\pm 10$ V)
Pin 2	RXD	Serial input (ca. $\pm 10$ V)

## 5.3 Mechanical Features

**Temperature range:****Display Control Unit**

- permissible operating temperature<sup>5</sup>: -20 °C ... +55 °C (short time +60 °C)
- permissible storage temperature: -30 °C ... +80 °C

**Antenna Unit**

- permissible operating temperature<sup>5</sup>: -40 °C ... +60 °C
- permissible storage temperature: -55 °C ... +80 °C

**Protective system:**

- Antenna Unit: IP 67

**Weights:**

- Display Control Unit: 0,25 kg
- Antenna Unit: 2 kg

**Dimensions:**

- Display Control Unit: 82 mm x 82 mm x 43,3 mm (width x height x depth)

<sup>5</sup> According to RTCA/EUROCAE DO-160D/ED-14D. Further details available in DDP (RHOTHETA-Document 12-9-1-0001-5-4-1-60). For temperatures lower than -10° C a warm-up period of 15 min should be allowed.

- LC Display: 60 mm x 32,5 mm (width x height)
- Antenna Unit:  $\varnothing 270$  mm x 185 mm

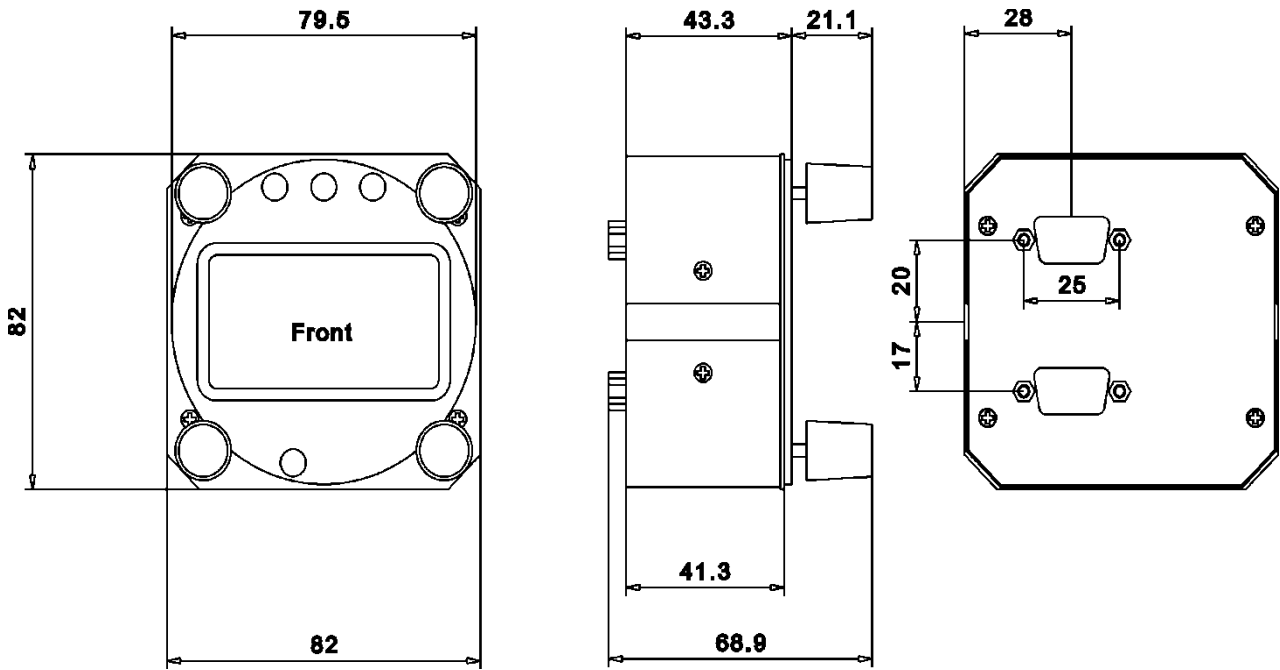

Fig 48) DCU Mechanical Drawing (all dimensions in [mm])

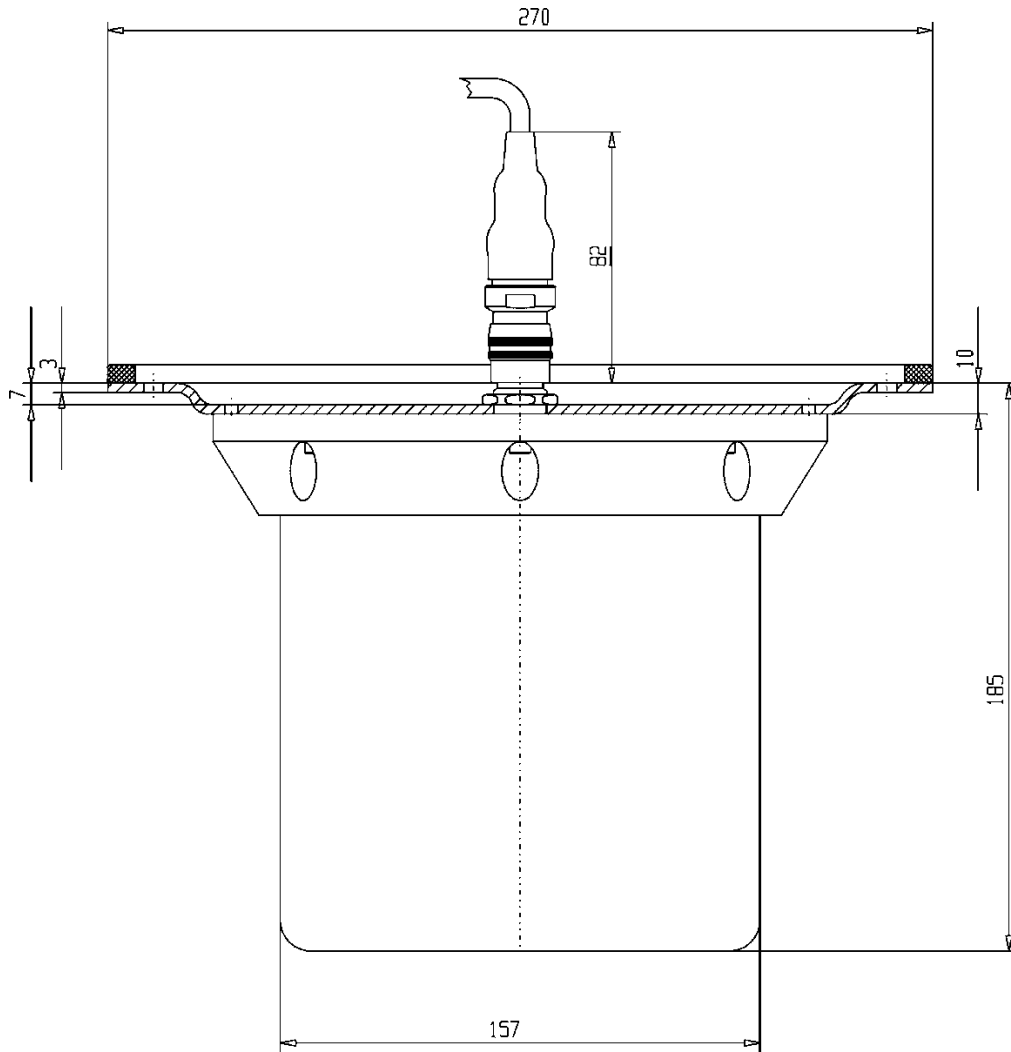
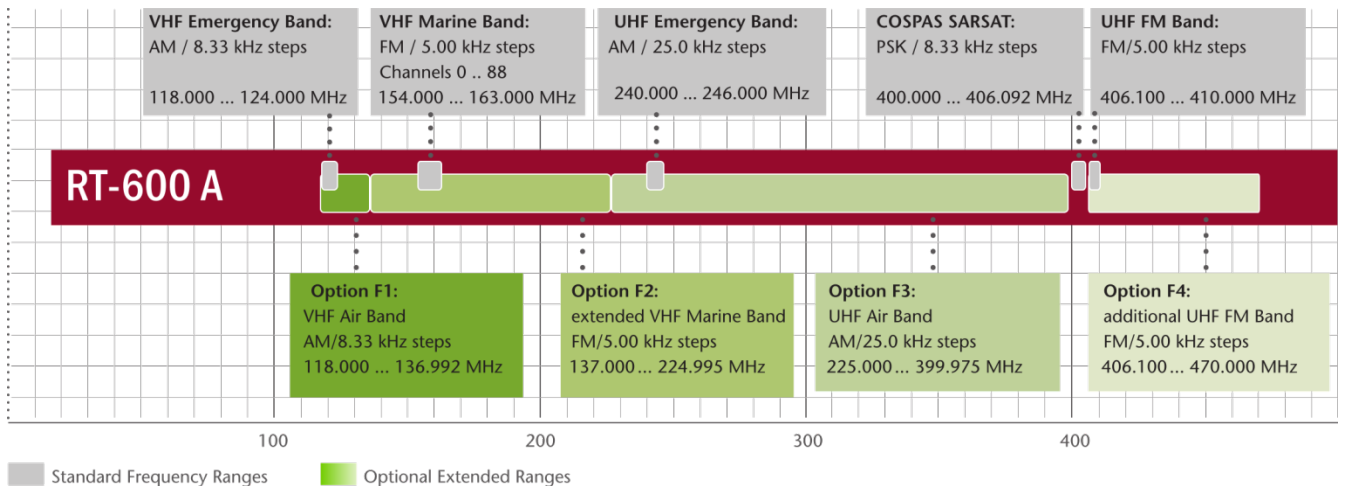
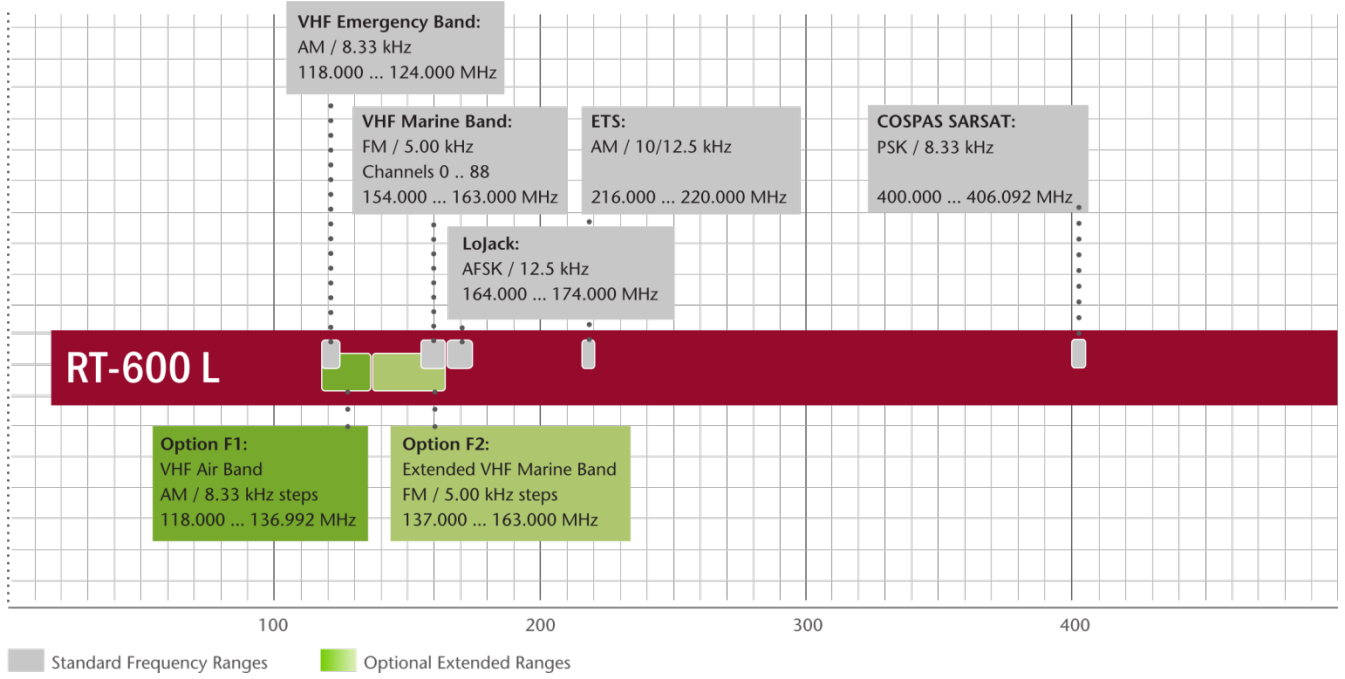

Fig 49) AU Mechanical Drawing (all dimensions in [mm])

## 6 Appendix

### 6.1 Frequency Ranges





## 6.2 Frequencies of channels on maritime band

Only for standard [A] version.

Frequency-range of the RT-600 in the maritime band: 156.000 MHz ... 162.025 MHz

Channel No.	frequency (ship - station)	Frequency (coast - station)
1	156,050 MHz	160,650 MHz
2	156,100 MHz	160,700 MHz
3	156,150 MHz	160,750 MHz
4	156,200 MHz	160,800 MHz
5	156,250 MHz	160,850 MHz
6	156,300 MHz	160,900 MHz
7	156,350 MHz	160,950 MHz
8		156,400 MHz
9		156,450 MHz
10		156,500 MHz
11		156,550 MHz
12		156,600 MHz
13		156,650 MHz
14		156,700 MHz
15		156,750 MHz
16		156,800 MHz
17		156,850 MHz
18	156,900 MHz	161,500 MHz
19	156,950 MHz	161,550 MHz
20	157,000 MHz	161,600 MHz
21	157,050 MHz	161,650 MHz
22	157,100 MHz	161,700 MHz
23	157,150 MHz	161,750 MHz
24	157,200 MHz	161,800 MHz
25	157,250 MHz	161,850 MHz
26	157,300 MHz	161,900 MHz
27	157,350 MHz	161,950 MHz
28	157,400 MHz	162,000 MHz
60	156,025 MHz	160,625 MHz
61	156,075 MHz	160,675 MHz
62	156,125 MHz	160,725 MHz
63	156,175 MHz	160,775 MHz
64	156,225 MHz	160,825 MHz
65	156,275 MHz	160,875 MHz
66	156,325 MHz	160,925 MHz
67		156,375 MHz
68		156,425 MHz
69		156,475 MHz
70		156,525 MHz
71		156,575 MHz
72		156,625 MHz
73		156,675 MHz
74		156,725 MHz
75		156,775 MHz
76		156,825 MHz
77		156,875 MHz
78	156,925 MHz	161,525 MHz
79	156,975 MHz	161,575 MHz
80	157,025 MHz	161,625 MHz
81	157,075 MHz	161,675 MHz
82	157,125 MHz	161,725 MHz
83	157,175 MHz	161,775 MHz
84	157,225 MHz	161,825 MHz
85	157,275 MHz	161,875 MHz
86	157,325 MHz	161,925 MHz
87	157,375 MHz	161,975 MHz
88	157,425 MHz	162,025 MHz

## 6.3 Serial interface data protocol (short description)

### 6.3.1 General

**Interface parameters:** RS232: 9600 Baud, 8 data bits, 1 stop bit, no parity, LSB sent first.

#### Timing of serial data:

For accurate use of the serial data (even for the optional serial input commands) the correct timing is mandatory.

The DCU (Display Control Unit) sends out via the RS-232 Pins (see 4.3 System Interconnect Wiring Diagram, page 40) cyclic and autonomous every approx. 250...300 ms a binary data stream, which contains all relevant DF-bearing information.

The output data contains one or two blocks of binary data (see next picture with accordingly description). The optional serial input is only used if changes (as example frequency change) are done by additional remote control units.

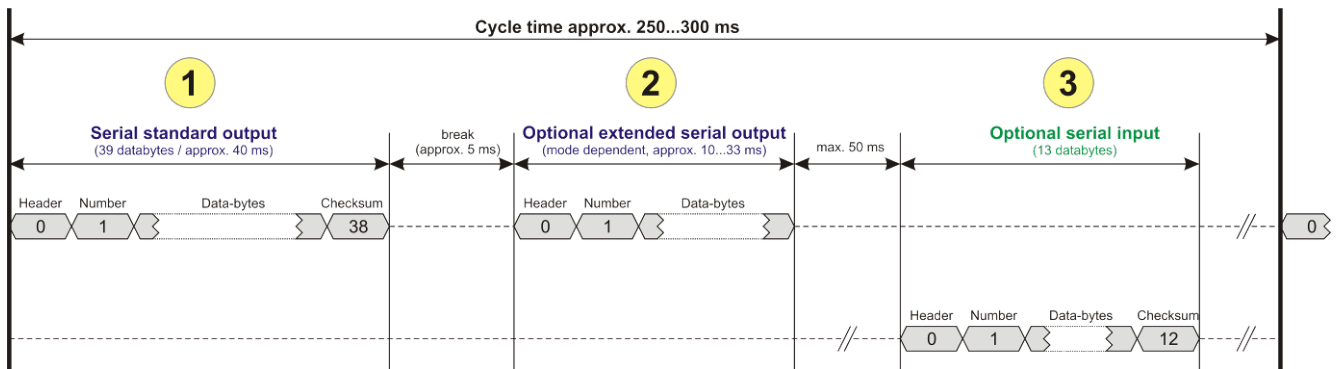

Fig 50) Timing of serial data

<b>1</b>	<p><b>Serial standard output:</b></p> <p>This output data is always available and contains all relevant DF-bearing data. For detailed content see 6.3.2.</p>
<b>2</b>	<p><b>Optional extended serial output:</b></p> <p>This data contains some additional information like as example COSPAS-SARSAT or LoJack decoding and ID data. For detailed content see 6.3.4.</p> <p>The data is only available with DCU Software [Rev ≥ 3.20] and if this optional data block is configured as ON = enabled (see 2.5, point (10)).</p> <p>Even to avoid compatibility problems with already existing, older remote control software, it is possible to disable / switch off this additional data block (see 2.5, point (10)).</p>
<b>3</b>	<p><b>Optional serial input:</b></p> <p>Only used for optional commands to control DCU parameters. If, as example the direction finder frequency is changed remotely, there is send to the DCU one time this data block with the new frequency. For detailed content see 6.3.5.</p>





Detailed Description of important values for practical use:

- **Status:** byte [2]  
Receiving Bit 0 of this value (LSB) indicates signal receiving.  
Bit 0 = 0, then no signal is received and so on no bearing is available.  
Bit 0 = 1, then bearing is possible.  
Bit 1: If = 1 then Squelch is controlled by AU (active at modes: COSPAS-SARSAT Decode, COSPAS-SARSAT Scanning, LoJack with Filter = ID only)
- **Error:** bytes [4...5] → 16 bit value  
Each set bit corresponds to the error no. (Refer to the chapter Error messages)  
Example:       - 0x0000 → No error  
              - 0x0800 → Bit No. 11 Set (= No AU Error)
- **Actual DCU Page:** byte [6]  
Indicates actual operating mode of DCU  
0 = Standard bearing page  
1 = Frequency memory page  
2 = COSPAS-SARSAT decoding page  
3 = LoJack decoding page (ID edit)
- **Frequency:** bytes [8...11] → 32 bit value  
Actual adjusted frequency [Hz]  
Example:       - 0x073DF160 → 1215000000 → 121.500 MHz
- **Active Band:**  
Standard Version [A]:  
0=VHF Airband; 1=VHF Marineband sea; 2=VHF Marineband coast; 3=UHF Airband; 4= COSPAS-SARSAT;  
  
LE Version [L]:  
0=VHF Airband; 1=LoJack; 2=Lifesaver; 3=ETS; 4= COSPAS-SARSAT;
- **Actual Squelchlevel:** byte [13] Range: [0...60]%  
Without signal, the actual squelchlevel should always be adjusted a little bit over the noise level (Refer to the chapter Squelch Operation)
- **Level:** byte [27] Range: [0...99] %  
Actual receiving level (without signal this value is equal to the noise level).  
If a signal is received, then this value corresponds to the signal strength of this signal.
- **Relative Bearing averaged:** byte [28...29] → 16 bit value Range [0...359, 0xFFFF]  
If the value = 0xFFFF, then no valid bearing is available, otherwise this value contains the actual averaged bearing information in Deg. [0°..359°].  
Example:       - 0X0114 → 276° bearing (= left side oriented to heading)
- **Bearing Live Min/Max:** byte [30...31] & [32...33] → 16 bit values Range [0...359, 0xFFFF]  
Only for signal quality or additional information – NOT recommended for bearing indication  
The relative live bearing field contains the max/min bearing in degrees without averaging. The relative live bearing reacts faster than the normal relative bearing, but it has not the precision of the averaged bearing.  
The Min/Max Bearing Values are calculated within a time period of approx. 250 ms. If they are very close together (for example “124” and “128” degrees), then the signal quality is quite good. A wide span of the min/max values (for example “97” and “162”) shows very noisy, but nevertheless bearable signal quality.



[5]	<b>Voltage</b> of Antenna Unit Power Supply input valid range: [80..255] (decimal, = 8.0 .. 25.5 V DC)		
[6]	<b>Temperature</b> inside Antenna Unit valid range: [-50..+100] (°C, signed byte value)		
[7..8]	<b>Relative Bearing (averaged)</b> valid range: [0..359] (decimal Deg, value=0xFFFF => bearing invalid)		
[9..10]	<b>Min. Live value of relative Bearing</b> valid range: [0..359] (Deg)	The relative live bearing field contains the max/min bearing in degrees without averaging. The relative live bearing reacts faster than the normal relative bearing, but it has <u>not the precision</u> of the averaged bearing.	
[11..12]	<b>Max. Live Value of relative Bearing</b> valid range: [0..359] (Deg)	The Min/Max Bearing Values are calculated within a time period of approx. 250ms. If they are very close together (as example "124" and "128") degrees, then the signal quality is quite good. A wide span of the min/max values (as example "97" and "162") shows very noisy, but nevertheless bearable signal quality.	
		Variant [L] only: Mode Filter = VLU (=0x93) or ID (=0x94) and Receiving=On	
		Byte No.	
[13..22]	<b>Up to 10 x LF Values</b> of modulated (AM or FM) audio receiving signal - the values are generated as a continuous data stream of the audio frequency - each value is measured within a time span of 40 ms in the Antenna Unit - if the duty cycle of this receiving data protocol has a timespan of 250ms => approx. 6 valid values are calculated. - each value != 0 is valid - the resolution of the value = 25 Hz (as Example a audio frequency of 800Hz => value = 32 decimal)  This values are used as example for identification of typical ELT modulated signals (sweep tone)	[13..17]	Lojack ID Replay Code 5 x ASCII Chars "No BIOZ" set
		18	Receiver Level Out Max [0..99]%
		19	LoJack Decoder Status: [0..7] - 0 : Off - 1 : Wait for Preamble - 2 : Preamble Ok - 3 : Flag Pattern Ok - 4 : Data Bit Error > 1 - 5 : Data Ok (No VLU) - 6 : VLU Ok - 7 : ID Ok (1 corrected bit) - 8 : ID Ok (no error)
		[20..21]	Not used
		22	Not used
[23]	<b>Frequency Offset</b> of received Transmitter (service value for RHOTHETA internal use) valid range: [-99..+99], [-111]=invalid; (depends on AFC On/Off Mode)		
[24]	<b>PsRam Bearing Value Right</b> (service value for RHOTHETA internal use) valid range: [0..179] (2° quant); [0xFF]=invalid		
[25]	<b>PsRam Bearing Value Left</b> (service value for RHOTHETA internal use) valid range: [0..179] (2° quant); [0xFF]=invalid		
[26..29]	<b>Minimum valid frequency</b> of the actual band (based on the actual frequency / transmit protocol byte [2..5])		
[30..33]	<b>Maximum valid frequency</b> of the actual band (based on the actual frequency / transmit protocol byte [2..5])		

**COSPAS-SARSAT Decoding data**

This data is only available and [valid](#), if:

Display Control Unit with actual software Rev ≥ 3.20 (see 2.1.2, page 11)

- Configuration of Extended serial = ON (see 2.5 Setup Edit Page, point (10))
- Direction Finder COSPAS-SARSAT decoding mode is activated by selecting the corresponding page (see COSPAS-SARSAT Decode Window, page 20 and page 21) and so on Header (byte 0 of data) = 0x91

A valid COSPAS-SARSAT decoding data protocol is always marked by the first data byte ([header = 0x91](#)). Always after receiving and decoding of a valid COSPAS-SARSAT pulse, the complete data protocol with 33 bytes is send out one time.

Byte No.	
[0]	<b>Header</b> = 0x91 (Identification for CP-Sarsat decoding mode)
[1]	<b>Number of bytes</b> - 7 if no decoded pulse is available - 33 if new pulse was received and is available
[2]	<b>Error</b>
[3]	<b>Bit[0]:</b> - 0 => No new 406 MSG (decoded data) available

	- 1 => New valid 406 MSG available (Sync & Frame Ok), Check Error Status for Bit-Errors <b>Bit[6..1]: AutoSquelch Level</b> valid range: [0..60] (% , decimal) <b>Bit[7] = 1: Squelch controlled by AU</b>
[4]	<b>Signal level</b> of received signal valid range: [0..99] (% , decimal)
[5]	<b>Voltage</b> of Antenna Unit Power Supply input valid range: [80..255] (decimal, = 8.0 .. 25.5 V DC)
[6]	<b>Temperature</b> inside Antenna Unit valid range: [-50..+100] (°C, signed byte value)

The following data bytes are only available,  
if a correct CP-Sarsat puls gets received and decoded with correct checksum

[7..24]	<b>18 x Data bytes</b> complete original CP-Sarsat 406 decoded message (144 bit) Data byte Nr: [ Byte 7 ] [ Byte 8 ] [Byte9 .. .. Byte24] 406 MSG Bit Nr: [1 2 3 4 5 6 7 8] [9 10 11 12 13 14 15 16] [17 .. .. 144]	
[25]	<b>S/N-Flag</b> valid values: 0x53='S'; 0x4E='N'; 0x2D='-' if no GPS data available	GPS-Position Latitude
[26]	<b>Deg</b> valid values: [0..90] (decimal, Deg) 0xFF if no GPS data available	
[27]	<b>Min</b> valid values: [0..59] (decimal, Deg) 0xFF if no GPS data available	
[28]	<b>Sec</b> valid values: [0..59] (decimal, Deg) 0xFF if no GPS data available	
[29]	<b>W/E-Flag</b> valid values: 0x57='W'; 0x45='E'; 0x2D='-' if no GPS data available	GPS-Position Longitude
[30]	<b>Deg</b> valid values: [0..180] (decimal, Deg) 0xFF if no GPS data available	
[31]	<b>Min</b> valid values: [0..59] (decimal, Deg) 0xFF if no GPS data available	
[32]	<b>Sec</b> valid values: [0..59] (decimal, Deg) 0xFF if no GPS data available	

### COSPAS-SARSAT Scanning data

This data is only available and valid, if:

Display Control Unit with actual software Rev ≥ 3.20 (see 2.1.2, page 11)

- Configuration of Extended serial = ON (see 2.5 Setup Edit Page, point (10))
- Direction Finder COSPAS-SARSAT scanning mode is activated by selecting the corresponding page (see COSPAS-SARSAT Scan Mode, page 23) and so on Header (byte 0 of data) = 0x92

A valid COSPAS-SARSAT scanning data protocol is always marked by the first data byte (header = 0x92).

Byte No.	
[0]	<b>Header</b> = 0x92 (Identification for CP-Sarsat scanning mode)
[1]	<b>Number of bytes</b> in the complete data stream = 0x0B (11 bytes)
[2]	<b>Error Bits</b> (see Error Bits Bearing Mode)
[3]	<b>Bit[0]: Receiving On/Off</b> - 0 => No puls received - 1 => Cospas-Sarsat puls received (see enclosed Frequency Byte[7..10]) <b>Bit[6..1]: AutoSquelch Level</b> valid range: [0..60] (% , decimal) <b>Bit[7] = 1: Squelch controlled by AU</b>
[4]	<b>Signal level</b> of received signal valid range: [0..99] (% , decimal)
[5]	<b>Voltage</b> of Antenna Unit Power Supply input valid range: [80..255] (decimal, = 8.0 .. 25.5 V DC)
[6]	<b>Temperature</b> inside Antenna Unit valid range: [-50..+100] (°C, signed byte value)
[7..10]	<b>Actual Frequency</b> at COSPAS-SARSAT scanning mode [Hz] Byte [7] [8] [9] [10]         MSB LSB Value = [406025000 .. 406075000] (Cp-Sarsat Band with 8.333kHz Grid) Example: Byte[7..10] = [0x18][0x33][0x93][0xB5] => COSPAS-SARSAT Frequency 406,033333 MHz

**LoJack ID data**

This data is only available and [valid](#), if:

Display Control Unit with actual software Rev ≥ 3.20 (see 2.1.2, page 11)

- Direction Finder of variant [L] Law Enforcement
- Configuration of Extended serial = ON (see 2.5 Setup Edit Page, point (10))
- Direction Finder is working with active LoJack >ID Filter<
- Header (byte 0 of data) = 0x93 or 0x94

Valid LoJack ID decoding data is always marked by the first data byte ([header = 0x93 or 0x94](#)).

Byte No.	
[0]	<b>Header</b> = 0x93 LoJack ID editing sub-page is selected / Filter = VLU, → all valid and received LoJack pulses are indicated = 0x94 Lojack Decode & DF Mode with active Filter = ID
[1]	<b>Number of bytes</b> in the complete data stream - decimal 26 = default value
[2]	Nonrelevant
[3]	<b>Bit[0]: Receiving On/Off</b> - 0 => No Receiving, no bearing - 1 => new LoJack pulse received
[4..12]	Nonrelevant
[13..17]	Lojack ID Replay Code, 5 x ASCII Chars, "No BIOZ" set Example ASCII = "000R1"
18	Receiver Level Out Max [0..99]%
19	LoJack Decoder Status: [0..7] - 0 : Off - 1 : Wait for Preamble - 2 : Preamble Ok - 3 : Flag Pattern Ok - 4 : Data Bit Error > 1 - 5 : Data Ok (No VLU) - 6 : VLU Ok - 7 : ID Ok (Filter=IDONLY)
[20..25]	Nonrelevant

Remark:

Only if byte no. [3], bit [0] gets "1" (Receiving On), then an active LoJack pulse is received and so on the corresponding LoJack ID valid, otherwise the LoJack ID only shows the actual adjusted LoJack Filter ID of the direction finder.

**Fast Band Scanning Data**

This data is only available and [valid](#), if:

Display Control Unit with actual software Rev ≥ 3.20 (see 2.1.2, page 11)

- Configuration of Extended serial = ON (see 2.5 Setup Edit Page, point (10))
- Marine Ship Scan mode is activated by selecting the corresponding page (see Marine Ship Scan Mode, page 24). Header (byte 0 of data) = 0x95

A valid fast band scanning data protocol is always marked by the first data byte ([header = 0x95](#)).

Byte No.	
[0]	<b>Header</b> = 0x95 (Identification for Bearing Mode)
[1]	<b>Number of bytes</b> in the complete data stream = 0x0B (11 bytes)
[2]	<b>Error Bits</b> (see Error Bits Bearing Mode)
[3]	<b>Bit[0]: Receiving On/Off</b> - 0 => No signal received - 1 => Signal receiving (see enclosed Frequency Byte[7..10]) <b>Bit[6..1]: AutoSquelch Level</b> valid range: [0..60] (% , decimal) <b>Bit[7] = 1: Squelch controlled by AU</b> <b>Bit[7]:</b> = 0 => Standard, Squelch level is controlled by DCU
[4]	<b>Signal level</b> of received signal valid range: [0..99] (% , decimal)

[5]	<b>Voltage</b> of Antenna Unit Power Supply input valid range: [80..255] (decimal, = 8.0 .. 25.5 V DC)
[6]	<b>Temperature</b> inside Antenna Unit valid range: [-50..+100] (°C, signed byte value)
[7..10]	<b>Actual Frequency</b> at scanning mode [Hz] Byte [7][8][9][10]          MSB   LSB Only valid if != 0 Example: Byte[7..10] = [0x09][0x5B][0x66][0xA8] => Frequency 156,985 MHz

### 6.3.5 Optional serial input (protocol description)

#### Specification serial input: (optional)

The serial input is normally used for service and maintenance, only. Nevertheless it is possible via this interface, to remote control the actual frequency and the squelch level of the DF system.

If a valid data stream is send to the DF, then the actual frequency selection at the DCU is switched to Block2 / AUX0. At this memory channel the new frequency is stored and used automatically. (Refer to the chapter Frequency Selection Page). If the frequency is changed (by one valid data stream) no more serial input is necessary. The actual frequency can be changed again at any time by manual operation at the DCU.

The timing of serial input (if used) is strictly fixed. The optional serial input has to take place directly after a complete serial output (max. 50 ms delay time).

If a new changed frequency is commanded to the DCU via this serial input interface, it can take up to 1 sec of time until this new frequency is ready for operation/bearing. It is strictly not recommended to use the frequency remote control for any scan mode. The frequency control has to be used for static frequency change only.

Register of data bytes:

byte no.															
[0]	Header 0xC0														
[1]	Number of bytes in the complete message (including header and checksumbyte)														
[2..3]	(not used for normal operation / any byte values allowed)														
[4]	Volume [0..100]%														
[5..8]	<b>Frequency [Hz]</b> (frequency is rounded to the according grid automatically) <table border="0" style="width: 100%;"> <tr> <td style="width: 50%;"><b>Valid Range for Standard Version:</b></td> <td style="width: 50%;"><b>Valid Range for LE Version:</b></td> </tr> <tr> <td>118000000 ... 123000000 [Hz] @ 8.333 kHz</td> <td>118000000 ... 123000000 [Hz] @ 8.333 kHz</td> </tr> <tr> <td>156050000 ... 162025000 [Hz] @ 5.000 kHz</td> <td>164000000 ... 174000000 [Hz] @ 8.333 kHz</td> </tr> <tr> <td>240000000 ... 246000000 [Hz] @ 8.333 kHz</td> <td>201000000 ... 215995000 [Hz] @ 5.000 kHz</td> </tr> <tr> <td>400000000 ... 410000000 [Hz] @ 8.333 kHz</td> <td>216000000 ... 218995000 [Hz] @ 12.500 kHz</td> </tr> <tr> <td></td> <td>219000000 ... 220000000 [Hz] @ 10.000 kHz</td> </tr> <tr> <td></td> <td>400000000 ... 410000000 [Hz] @ 8.333 kHz</td> </tr> </table>	<b>Valid Range for Standard Version:</b>	<b>Valid Range for LE Version:</b>	118000000 ... 123000000 [Hz] @ 8.333 kHz	118000000 ... 123000000 [Hz] @ 8.333 kHz	156050000 ... 162025000 [Hz] @ 5.000 kHz	164000000 ... 174000000 [Hz] @ 8.333 kHz	240000000 ... 246000000 [Hz] @ 8.333 kHz	201000000 ... 215995000 [Hz] @ 5.000 kHz	400000000 ... 410000000 [Hz] @ 8.333 kHz	216000000 ... 218995000 [Hz] @ 12.500 kHz		219000000 ... 220000000 [Hz] @ 10.000 kHz		400000000 ... 410000000 [Hz] @ 8.333 kHz
<b>Valid Range for Standard Version:</b>	<b>Valid Range for LE Version:</b>														
118000000 ... 123000000 [Hz] @ 8.333 kHz	118000000 ... 123000000 [Hz] @ 8.333 kHz														
156050000 ... 162025000 [Hz] @ 5.000 kHz	164000000 ... 174000000 [Hz] @ 8.333 kHz														
240000000 ... 246000000 [Hz] @ 8.333 kHz	201000000 ... 215995000 [Hz] @ 5.000 kHz														
400000000 ... 410000000 [Hz] @ 8.333 kHz	216000000 ... 218995000 [Hz] @ 12.500 kHz														
	219000000 ... 220000000 [Hz] @ 10.000 kHz														
	400000000 ... 410000000 [Hz] @ 8.333 kHz														
[9]	<b>Squelchlevel</b> Manual = [0..60] % Autosql= [ -1] Warning, use only for pulsed signals! (as example: CpSarsat, LoJack)														
[10]	(not used for normal operation / any byte values allowed)														
[11]	Internal Dimming [0..100%]														
[12]	Checksum is the 2's complement of the modulo-256 sum of all bytes without checksum-byte [0..n-1]														