

User Manual

RT-800

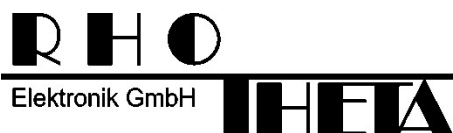

Edited by:

RHOTHETA Elektronik GmbH
Kemmelpark
Dr.-Ingeborg-Haeckel-Str. 2
82418 Murnau
Germany

Tel.: +49 8841 4879 - 0
Fax: +49 8841 4879 - 15

Internet: www.rhotheta.de
E-Mail: email@rhotheta.de

*Copyright © RHOTHETA Elektronik GmbH
All rights reserved*

- *Issue: 2024/02/20 [Rev 3.04]*
- *Document-ID: 12-9-1-0003-3-1-61*
- *Valid for RT-800 systems with revision [Rev 3.03] or higher*

Note

The manufacturer reserves the right to make modifications to the product described here at any time and without previous information.

Content

| | | |
|----------|--|-----------|
| 1 | Legend of Signal Words | 10 |
| 2 | Safety | 10 |
| 2.1 | General Safety Information | 10 |
| 2.2 | Basic Safety Instructions | 11 |
| 3 | Legal Information | 11 |
| 3.1 | Declaration of Conformity (EU) | 11 |
| 3.2 | Legal Limitations of Use within the EU | 12 |
| 3.3 | FCC Information (USA) | 12 |
| 3.4 | ISED Information (Canada) | 12 |
| 4 | General Description | 13 |
| 5 | Overview | 14 |
| 5.1 | Front View (DCU) | 14 |
| 5.2 | Front View (Control Panel) | 15 |
| 5.3 | Rear View | 18 |
| 6 | Operation | 20 |
| 6.1 | Bearing Page | 21 |
| 6.1.1 | Bearing Indication | 21 |
| 6.1.2 | Bearing Operation | 26 |
| 6.1.3 | Function Channel 16 | 41 |
| 6.1.4 | Function Repeat | 41 |
| 6.1.5 | Function Clear | 42 |
| 6.1.6 | Function Autoset Squelch | 42 |
| 6.2 | Scan Page | 44 |
| 6.2.1 | COSPAS-SARSAT Scan | 46 |
| 6.2.2 | Monitoring | 48 |
| 6.2.3 | Fast Channel Scan | 54 |
| 6.2.4 | Marine Scan | 59 |
| 6.2.5 | SAR Scan | 63 |
| 6.2.6 | Scan List | 69 |
| 6.3 | Decode Page | 74 |
| 6.3.1 | Selecting a COSPAS-SARSAT frequency | 76 |
| 6.3.2 | COSPAS-SARSAT List View | 76 |
| 6.3.3 | COSPAS-SARSAT Bearing View | 77 |
| 6.3.4 | COSPAS-SARSAT Bearing and List | 79 |
| 6.3.5 | Export to Bearing Page | 79 |
| 6.4 | Setup Page | 81 |
| 6.4.1 | General | 81 |
| 6.4.2 | Display | 92 |
| 6.4.3 | System | 110 |
| 6.4.4 | Interface | 131 |
| 6.4.5 | Service | 150 |
| 6.5 | Other Operational Functions | 153 |

| | | |
|----------|--|------------|
| 6.5.1 | Standby Mode..... | 153 |
| 6.5.2 | Adjusting the Volume..... | 153 |
| 6.5.3 | Adjusting of the Squelch..... | 154 |
| 6.5.4 | Dimming and Day/Night Mode..... | 155 |
| 7 | Interfaces and Installation..... | 158 |
| 7.1 | Power & I/O | 158 |
| 7.2 | Antenna Unit (Connecting Cable DCU ↔ AU)..... | 159 |
| 7.2.1 | Pinning Antenna Unit Connector | 159 |
| 7.2.2 | Connecting Cable DCU ↔ AU..... | 160 |
| 7.3 | NMEA COM-Interfaces | 160 |
| 7.4 | LAN Interface..... | 161 |
| 7.5 | Remote Control and IP-Audio Encoder Ports..... | 162 |
| 7.6 | Power Supply..... | 163 |
| 8 | Installation and Configuration | 164 |
| 8.1 | General Information | 164 |
| 8.2 | Installation Recommendation | 164 |
| 8.3 | Line of Sight and Fresnel Zone | 165 |
| 8.4 | Reduced Bearing Accuracy Caused by Reflections..... | 166 |
| 8.5 | Overview of favorable and unfavorable Installation Locations | 166 |
| 8.6 | Lightning Protection | 167 |
| 8.7 | Antenna Alignment | 167 |
| 8.8 | Antenna Connection | 168 |
| 8.9 | DCU Configuration..... | 168 |
| 8.9.1 | Interface Configuration | 168 |
| 8.9.2 | Audio Line Output Configuration..... | 168 |
| 8.9.3 | Antenna Unit Configuration..... | 169 |
| 8.10 | Configuration of Remote Control over IP | 169 |
| 8.10.1 | General..... | 169 |
| 8.10.2 | IP Network Settings & Web Console Connection using MOXA..... | 170 |
| 8.11 | Configuration of Audio over IP (streaming into LAN) | 172 |
| 8.11.1 | General..... | 172 |
| 8.11.2 | IP Network settings & Web Console Connection..... | 173 |
| 8.12 | Configuration of Audio Extreamer (streaming from LAN)..... | 175 |
| 8.12.1 | Configuration of Extreamer at Remote Site | 176 |
| 8.13 | Example of complete Network Scenario..... | 177 |
| 9 | Technical Data | 178 |
| 9.1 | Electrical Characteristics | 178 |
| 9.2 | Mechanical Characteristics..... | 180 |
| 9.2.1 | DCU Dimensions (built-in version)..... | 180 |
| 9.2.2 | DCU Dimensions (tabletop version) | 181 |
| 9.2.3 | DCU Mechanical Characteristics | 181 |
| 9.2.4 | Antenna Unit Dimensions | 182 |
| 9.2.5 | Antenna Unit Mast Flange | 183 |
| 9.2.6 | Antenna Unit Mechanical Characteristics..... | 183 |

| | |
|--|------------|
| 10 Disposal within the European Union | 184 |
| 11 Disposal outside the European Union | 184 |
| 12 Maintenance and Cleaning..... | 184 |
| 12.1 Maintenance | 184 |
| 12.2 Cleaning..... | 184 |
| 13 Appendix | 185 |
| 13.1 Error Messages | 185 |
| 13.2 Warnings..... | 185 |
| 13.3 Setup Tree View (Settings)..... | 186 |
| 13.4 Default / User System Configuration Table | 187 |
| 13.5 Scan Page Tree View (Settings) | 189 |
| 13.6 Frequencies of channels on maritime band | 190 |
| 13.7 Channel Spacing UHF / VHF Air Band..... | 191 |
| 13.8 Abbreviations | 192 |

List of figures

| | |
|---|----|
| Fig. 1 Front View – DCU..... | 14 |
| Fig. 2 Front View – Buttons and Display..... | 15 |
| Fig. 3 Rear view..... | 18 |
| Fig. 4 Basic structure of pages | 20 |
| Fig. 5 Bearing display | 21 |
| Fig. 6 Digital bearing display (active signal reception)..... | 27 |
| Fig. 7 Digital bearing display (signal reception ended 2 seconds ago)..... | 28 |
| Fig. 8 Input of a new frequency | 32 |
| Fig. 9 Swap frequencies | 33 |
| Fig. 10 Input of a new channel..... | 35 |
| Fig. 11 Changing from "Channel" to "Frequency" when channel input is complete | 35 |
| Fig. 12 Switching to "Channel" when "Standby" frequency = 121.500 MHz | 36 |
| Fig. 13 Channel input with non-marine active frequency | 36 |
| Fig. 14 Input of a new COSPAS-SARSAT frequency | 37 |
| Fig. 15 Memory Dialog. Top level | 38 |
| Fig. 16 Editing the frequency name | 40 |
| Fig. 17 Repeat indication | 41 |
| Fig. 18 Scan page. General view..... | 44 |
| Fig. 19 Cospas-Sarsat scan mode with the last result indication..... | 46 |
| Fig. 20 "Exclude List" use indication..... | 46 |
| Fig. 21 Cospas-Sarsat Scan indication on the "Bearing" page | 47 |
| Fig. 22 "Cospas-Sarsat Scan" mode has been activated | 47 |
| Fig. 23 Confirming of leaving the scan mode..... | 48 |
| Fig. 24 "Monitoring" mode. Indication of frequencies..... | 49 |
| Fig. 25 "Monitoring" mode. Example views of the "Bearing" page | 49 |
| Fig. 26 "Monitoring CP-SS" mode. Example views of the "Bearing" page | 50 |
| Fig. 27 Example: Timing normal monitoring | 51 |
| Fig. 28 Example: Timing Cospas-Sarsat monitoring..... | 51 |
| Fig. 29 "Monitoring" has been activated | 52 |
| Fig. 30 Confirming of leaving the scan mode..... | 52 |
| Fig. 31 Monitoring mode settings..... | 53 |
| Fig. 32 Editing the current frequency | 53 |
| Fig. 33 Hold time setting | 54 |
| Fig. 34 Fast channel scan indication on the "Bearing" page..... | 56 |
| Fig. 35 Activating the "Fast Channel Scan" | 57 |
| Fig. 36 Confirming of leaving the scan mode..... | 57 |
| Fig. 37 Fast channel scan settings | 58 |
| Fig. 38 Input of a new frequency to be scanned | 58 |
| Fig. 39 Marine scan. Indication of frequencies | 59 |
| Fig. 40 Marine scan indication on the "Bearing" page | 60 |
| Fig. 41 Marine scan is activated | 61 |
| Fig. 42 Marine scan settings..... | 61 |
| Fig. 43 „Exclude List“ configuration | 62 |
| Fig. 44 SAR scan. Indication of frequencies..... | 64 |
| Fig. 45 "SAR scan" mode. Example views of the "Bearing" page..... | 65 |
| Fig. 46 Example: Timing SAR scan, if no frequency is detected | 65 |
| Fig. 47 Example: Timing SAR scan, if only COSPAS-SARSAT frequency is detected | 66 |
| Fig. 48 Example: Timing SAR scan, if no CP-SS pulse but a signal on an emergency frequency is detected | 66 |
| Fig. 49 Selecting SAR scan..... | 67 |

| | | |
|----------|--|-----|
| Fig. 50 | Confirming of leaving the scan mode..... | 67 |
| Fig. 51 | SAR scan. Edit scan settings..... | 68 |
| Fig. 52 | Alternating hotkeys | 68 |
| Fig. 53 | Scan List. Indication of frequencies | 69 |
| Fig. 54 | "Scan List" is activated | 70 |
| Fig. 55 | Result List Settings | 71 |
| Fig. 56 | "Search List" settings..... | 71 |
| Fig. 57 | "Scan List Conditions" dialog | 73 |
| Fig. 58 | Decode Page. General view | 74 |
| Fig. 59 | Confirming a new COSPAS-SARSAT message..... | 76 |
| Fig. 60 | Decode Page. COSPAS-SARSAT List View | 76 |
| Fig. 61 | Decode Page: Bearing View | 78 |
| Fig. 62 | Dialog for confirming of deleting all CP-SS messages..... | 78 |
| Fig. 63 | "Decode" page. "Bearing and List" view | 79 |
| Fig. 64 | Indication of the GPS based bearing on the Bearing page..... | 80 |
| Fig. 65 | Setup page. General settings (administrator view) | 82 |
| Fig. 66 | Setup page, General settings appearance for the access level "Operator" | 84 |
| Fig. 67 | Setup page, General settings appearance for the access level "Administrator" | 84 |
| Fig. 68 | Accessing the administrator level | 85 |
| Fig. 69 | Changing password | 86 |
| Fig. 70 | Changing the administrator password | 86 |
| Fig. 71 | Edit value dialog for access level..... | 87 |
| Fig. 72 | Editing the access level to "Operator"..... | 87 |
| Fig. 73 | Editing the value for the audio beeper | 88 |
| Fig. 74 | Edit value of the audio line output level | 88 |
| Fig. 75 | Edit value for the speaker | 89 |
| Fig. 76 | Frequency information dialog | 89 |
| Fig. 77 | Locked frequencies. Operator view | 90 |
| Fig. 78 | Locked frequencies. Administrator view | 90 |
| Fig. 79 | "System Info" dialog..... | 91 |
| Fig. 80 | Setup page. Display settings | 92 |
| Fig. 81 | Editing the bearing indication hold time | 94 |
| Fig. 82 | Bearing reference direction dialog | 95 |
| Fig. 83 | Bearing scale offset editing dialog | 96 |
| Fig. 84 | Bearing scale orientation editing dialog | 96 |
| Fig. 85 | Types of the frequency/channel indication..... | 97 |
| Fig. 86 | "Channel Indication" dialog..... | 97 |
| Fig. 87 | Changing the distance unit | 98 |
| Fig. 88 | Changing the level unit | 99 |
| Fig. 89 | Light sensor settings..... | 99 |
| Fig. 90 | Changing the minimum range value of the light sensor | 100 |
| Fig. 91 | Changing the maximum range value of the light sensor | 100 |
| Fig. 92 | Changing the time delay value for the light sensor | 101 |
| Fig. 93 | Standby mode settings dialog..... | 101 |
| Fig. 94 | Adjusting the standby brightness..... | 102 |
| Fig. 95 | Changing the standby key illumination setting | 103 |
| Fig. 96 | Changing the standby deactivation setting | 104 |
| Fig. 97 | Dark mode activation warning | 104 |
| Fig. 98 | Manual deactivation of the standby mode is turned on..... | 105 |
| Fig. 99 | Activation of the dark mode with disabled illumination..... | 105 |
| Fig. 100 | Dark mode indication on the "Display" page..... | 106 |

| | | |
|----------|--|-----|
| Fig. 101 | Selecting the night mode settings | 106 |
| Fig. 102 | "Night Mode Settings" dialog | 107 |
| Fig. 103 | Turning on/off the automatic activation of night mode | 107 |
| Fig. 104 | Selecting the „Activation Threshold“ for editing the value | 108 |
| Fig. 105 | Changing the value for the night mode activation threshold | 109 |
| Fig. 106 | Setup page. System settings | 110 |
| Fig. 107 | Alarm pulse settings | 112 |
| Fig. 108 | Active direction dialog | 112 |
| Fig. 109 | Alarm mode dialog | 113 |
| Fig. 110 | Time off Dialog | 114 |
| Fig. 111 | Time on Dialog | 114 |
| Fig. 112 | Antenna unit (mounting position) dialog | 115 |
| Fig. 113 | Antenna mechanical correction dialog | 115 |
| Fig. 114 | Antenna installation dialog | 116 |
| Fig. 115 | AU calibration dialog | 117 |
| Fig. 116 | Beep tone decoding settings | 117 |
| Fig. 117 | Dialog for the upper frequency (Beep Tone Decoding) | 118 |
| Fig. 118 | Dialog for the lower frequency (Beep Tone Decoding) | 118 |
| Fig. 119 | Decoding time dialog | 119 |
| Fig. 120 | Frequency input hold time dialog | 119 |
| Fig. 121 | Locked frequencies list. Administrator view | 120 |
| Fig. 122 | Input of the magnetic variation value | 121 |
| Fig. 123 | Monitoring handling settings | 121 |
| Fig. 124 | Own GPS position dialog | 122 |
| Fig. 125 | Own position in DD format | 123 |
| Fig. 126 | Editing the own GPS coordinates | 123 |
| Fig. 127 | PS Ram compensation dialog | 124 |
| Fig. 128 | S/N Ratio for auto squelch function | 125 |
| Fig. 129 | Scan page settings dialog | 125 |
| Fig. 130 | Selecting the time settings | 126 |
| Fig. 131 | Time settings dialog | 126 |
| Fig. 132 | Changing the UTC time | 127 |
| Fig. 133 | Selecting time zone setting | 128 |
| Fig. 134 | "Select Timezone" dialog | 128 |
| Fig. 135 | Selecting the "Display Time" setting | 129 |
| Fig. 136 | Changing the "Display Time" setting | 129 |
| Fig. 137 | Selecting summer time setting | 130 |
| Fig. 138 | Changing summer time setting | 130 |
| Fig. 139 | Setup page. Interface settings | 131 |
| Fig. 140 | COM monitoring dialog | 133 |
| Fig. 141 | NMEA DF remote control configuration | 134 |
| Fig. 142 | Remote communication port configuration | 135 |
| Fig. 143 | Remote control baud rate configuration | 136 |
| Fig. 144 | Remote control address ID configuration | 136 |
| Fig. 145 | LAN configuration menu | 137 |
| Fig. 146 | Changing the mode of the IP address assignment | 138 |
| Fig. 147 | Setting the new IP address | 139 |
| Fig. 148 | Changing the netmask value | 139 |
| Fig. 149 | Changing the gateway value | 140 |
| Fig. 150 | Restart dialog | 140 |
| Fig. 151 | Changing the TCP port | 141 |

| | |
|---|-----|
| Fig. 152 Compass configuration settings..... | 142 |
| Fig. 153 Compass connector setting | 143 |
| Fig. 154 Compass baud rate setting | 143 |
| Fig. 155 Compass header setting..... | 144 |
| Fig. 156 NMEA GPS configuration settings..... | 145 |
| Fig. 157 NMEA GPS communication port settings | 146 |
| Fig. 158 Changing the NMEA GPS baud rate setting..... | 147 |
| Fig. 159 Dialog for setting the GPIOs | 147 |
| Fig. 160 Assigning a function to the input pin | 148 |
| Fig. 161 Assigning a function to the output pin | 149 |
| Fig. 162 Setup page. Service menu | 150 |
| Fig. 163 Input license dialog | 151 |
| Fig. 164 Input of a new license | 152 |
| Fig. 165 New license adopted | 152 |
| Fig. 166 "Adjust External Speaker Volume" dialog | 154 |
| Fig. 167 Squelch dialog | 155 |
| Fig. 168 "Adjust Brightness" dialog..... | 156 |
| Fig. 169 "Adjust Brightness" dialog in night color scheme | 156 |
| Fig. 170 Example of optimal antenna position | 165 |
| Fig. 171 Line of Sight and Fresnel Zone..... | 165 |
| Fig. 172 Reflections at fixed locations | 166 |
| Fig. 173 Illustration of adverse topographical effects..... | 166 |
| Fig. 174 Illustration of adverse effects in the landscape | 167 |
| Fig. 175 North / 0° marking of Antenna Unit..... | 168 |
| Fig. 176 Remote Control LAN connector..... | 169 |
| Fig. 177 Audio streaming to LAN connector | 172 |
| Fig. 178 Example of complete Network scenario..... | 177 |
| Fig. 179 RT-800, mechanical dimensions (built-in version) | 180 |
| Fig. 180 RT-800, mechanical dimensions (tabletop version)..... | 181 |
| Fig. 181 Antenna Unit, mechanical dimensions..... | 182 |
| Fig. 182 Antenna Unit, mast flange (mechanical dimensions)..... | 183 |

1 Legend of Signal Words

Note

This symbol designates tips or additional notes that must be paid attention to and make work easier.

Caution

Means that ignoring the instructions may lead to property damage or loss of data.

Warning

Means that ignoring the instructions, there may be a danger to health or life.

2 Safety

2.1 General Safety Information

RHOTHETA Elektronik GmbH is constantly trying to keep the safety standard of their products up to date and to offer their customers the highest possible level of safety. RHOTHETA products are designed and tested in accordance with the valid safety regulations. The compliance with these standards is continuously monitored by our quality assurance system.

This product is tested and left the factory in perfect technical and safety-relevant condition. To maintain this condition and to ensure safe operation, the user must pay attention to all instructions and warnings given. For any questions regarding these safety instructions, RHOTHETA Elektronik GmbH can be contacted at any time.

The observance of the safety instructions will help to prevent personal injury or damage caused by all kinds of dangers. This requires that the following safety instructions must be read carefully and understood before using the product, as well as observed while using the product. Other additional safety instructions, such as for protecting persons, appear in relevant parts of the product documentation and must also be paid attention to.

In addition, it is the responsibility of the user to use the product appropriately. The product RT-800, a professional direction finder system, shall not be used in any way that results in personal injury or property damage.

The use of this product for other than its designated purpose or in disregard of the instructions of the manufacturer is the responsibility of the user. The manufacturer takes no responsibility for the misuse of the product.

The manufacturer is not liable beyond the scope of legal rules!

This guide is part of the product RT-800 and must be kept with the product throughout its lifetime.

2.2 Basic Safety Instructions

Caution / Warning

Read and observe the following instructions, warnings and safety guidelines from the manufacturer!

- At all times, the local or national safety and accident prevention regulations must be observed.
- When installing or operating with the product, always follow the manufacturer's instructions.
- Only place the product on appropriate locations.
- Do not expose the product to environmental conditions (heat, humidity, wind load etc.) that exceed the specified conditions in the manuals.
- Use only the manufacturer's prescribed components and/or use only recommended materials and do not change them. Any other use or unauthorized modifications to the product will void the authorization to operate it.
- Connect only approved accessories kits or additional equipment.
- This product contains a Lithium battery cell containing harmful substances.
- Ensure that the connections with information technology equipment, e.g. industrial computers, comply with the IEC 62368-1/EN 62368-1 standards that applies in each case.
- This product may only be installed and opened by authorized personnel. The connector must always be disconnected before opening.
- This stationary, plug-in type A equipment has a permanently connected protective grounding conductor. The connection of the protective earth must be carried out by an authorized person.
- The power supply cord with plug is used as the disconnect device. It is pluggable and shall remain easily operable and should not be obstructed during intended use.

3 Legal Information

3.1 Declaration of Conformity (EU)

Hereby RHOTHETA Elektronik GmbH declares that the product RT-800 complies with the essential requirements and other relevant provisions of:

- Directive 2014/53/EU relating to radio equipment (relevant for RT-800 AU)
- Directive 2014/30/EU relating to electromagnetic compatibility (relevant for RT-800 DCU)
- Directive 2014/35/EU relating to the making available on the market of electrical equipment designed for use within certain voltage limits (relevant for RT-800 DCU)
- Directive 2011/65/EU on the restriction of the use of certain hazardous substances in electrical and electronic equipment (relevant for RT-800 and RT-800 DCU)

The full text of the Declaration of Conformity can be found at:

http://www.rhotheta.com/products/rt_800

3.2 Legal Limitations of Use within the EU

Due to its conformance to “Directive 2014/53/EU on the harmonisation of the laws of the Member States relating to the making available on the market of radio equipment and repealing Directive 1999/5/EC”, declared in the EU declaration of conformity, the equipment may be used within the European Union without limitations regarding the use of frequencies in those countries.

Please also consider national limitations or requirements for special operational permissions in your country.

3.3 FCC Information (USA)

Changes or modifications not expressly approved by the party responsible for compliance (RHOTHETA) could void the user's authority to operate the equipment.

Note

RT-800 AU has been tested and found to comply with the limits for a Class B digital device, pursuant to part 15 of the FCC Rules. These limits are designed to provide reasonable protection against harmful interference in a residential installation. This equipment generates, uses, and can radiate radio frequency energy and, if not installed and used in accordance with the instructions, may cause harmful interference to radio communications. However, there is no guarantee that interference will not occur in a particular installation. If this equipment does cause harmful interference to radio or television reception, which can be determined by turning the equipment off and on, the user is encouraged to try to correct the interference by one or more of the following measures:

- Reorient or relocate the receiving antenna.
- Increase the separation between the equipment and receiver.
- Connect the equipment into an outlet on a circuit different from that to which the receiver is connected.
- Consult the dealer or an experienced radio/TV technician for help.

3.4 ISED Information (Canada)

This device contains license-exempt transmitter(s) / receiver(s) that comply with Innovation, Science and Economic Development Canada's license-exempt RSS(s). Operation is subject to the following two conditions:

- (1) This device may not cause interference.
- (2) This device must accept any interference, including interference that may cause undesired operation of the device.

L'émetteur/récepteur exempt de licence contenu dans le présent appareil est conforme aux CNR d'Innovation, Sciences et Développement économique Canada applicables aux appareils radio exempts de licence.

L'exploitation est autorisée aux deux conditions suivantes:

- (1) L'appareil ne doit pas produire de brouillage;
- (2) L'appareil doit accepter tout brouillage radioélectrique subi, même si le brouillage est susceptible d'en compromettre le fonctionnement.

A radio license must be obtained prior to possession and use of this scanner receiver. Une licence radio doit être obtenue avant la possession et l'utilisation de ce récepteur de scanner.

4 General Description

The DF-system RT-800 combines a communication direction finder and a SAR (Search and Rescue) direction finder, thus allowing to bear all coastal and maritime radio stations. EPIRB (Emergency Position Indicating Radio Beacon) equipped persons or vessels may be found quickly and safely.

The DF-system RT-800 allows the bearing of radio signals on 5 different frequency bands as well as traditional emergency frequencies in the VHF and UHF range, the common calling up channel 16 in the maritime radio band and the widely used Cospas-Sarsat emergency signals. Optionally the whole frequency range 118,000 MHz – 470,000MHz could be unlocked.

| RT-800 Frequency Range | | | |
|------------------------------|-------------------------|------------------------------|-------------------------|
| Standard Range | | Optional Extended Range | |
| VHF emergency band | 118.000 ... 124.000 MHz | F1: VHF air band | 118.000 ... 136.992 MHz |
| VHF marine band ¹ | 154.000 ... 163.000 MHz | F2: extended VHF marine band | 137.000 ... 224.995 MHz |
| UHF emergency band | 240.000 ... 246.000 MHz | F3: UHF air band | 225.000 ... 399.975 MHz |
| COSPAS - SARSAT | 400.000 ... 406.092 MHz | - | - |
| UHF FM band | 406.100 ... 410.000 MHz | F4: additional UHF FM band | 406.100 ... 470.000 MHz |

Table 1. RT-800 frequency ranges

Fully automatic bearing of emergency signals in the monitoring and standby mode guarantees additionally a permanent emergency surveillance and the auto alert function. The DF-system consists of two units, the bearing AU (Antenna Unit) and the operating device DCU (Display Control Unit).

The bearing antenna is a dipole antenna, its housing contains all bearing electronics. Thus, short bearing signal paths with low loss, but also high insensitiveness to external disturbing fields are achieved. The DF-system is working with the Doppler principle, and by the high rotation frequency of 3 kHz and clockwise / counterclockwise rotation of the antenna to compensate running time errors, highest precision of the system is achieved.

The indicating and operating system (DCU) represents bearing signals and allows operating and controlling of the bearing antenna. External devices (speaker, audio / line out, compass etc.) can be connected to the RT-800 DCU. Data in- and export is possible by various interfaces including remote control over IP and IP-based audio transmission.

The DF-system is suitable for stationary surveillance of coastal ship traffic as well as for mobile use on big vessels. The AU is watertight (protection IP 67) and may be used under extreme and rough conditions. Optionally a lightning protection rod is available for costal VTS installations.

Warning

The DF-system RT-800 is not licensed for primary navigation. It may support navigation, if necessary, but navigation of a vessel may not be based on data obtained by the DF-system.

¹ Inclusive all maritime channels (ship / coast): channels 00 ... 88 (156,000 ... 162,025 MHz)

5 Overview

5.1 Front View (DCU)



Fig. 1 Front View – DCU

Front Control Elements





| Pos. | Element | Function Description |
|------|---------------|--|
| 1 | Control Panel | Display of bearing data; local control of the direction finder |
| 2 | Speaker | Audio speaker for received signal (volume is adjustable with button ). |
| 3 | Power Switch | Switches system power on and off |







Table 2 Front elements

5.2 Front View (Control Panel)



Fig. 2 Front View – Buttons and Display

| Front Control Elements | | |
|------------------------|---|---|
| Pos. | Element | Function Description |
| 1 |  | Switches the control panel on/off. When the control panel is turned on, the key is highlighted in green. In the case of an error the key will blink red. |
| 2 |  | Provides the standby operation to save energy. By pressing this button, the standby is activated, and the button is highlighted in orange. While in standby, the brightness of the display's backlight is driven down to a defined value (configurable in the "Setup" page, s. 6.4.2.8), but the system continues monitoring the corresponding (emergency) frequency. The display will be turned on again if an event occurs (e.g., signal level rises above squelch level, alarm occurs, scan algorithm finds an active frequency). Pressing any button will return the system from standby to normal operation mode (the function of the pressed button will not be executed). |
| 3 |  | The volume adjustment button contains two keys (+ and -). Pressing any of the two keys opens a dialog for adjusting the internal and external speakers (s. 6.5.2). |
| 4 |  | Switches the volume off/on (mute function). |

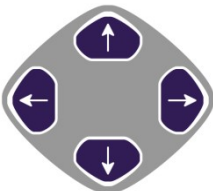
| | | |
|-----------|---|---|
| | | The mute-status is indicated by the orange highlight of the button. The volume can be turned on by pressing the same button again. While the mute function is activated, it is still possible to increase or decrease the volume without producing any sound (using the button for volume adjustment, s. 3). |
| 5 |  | The brightness adjustment button contains two keys (+ and -). Pressing any of the two keys opens the dialog window for brightness adjustment of the TFT-display backlight, status keys (labeled "Keys" in the "Adjust Brightness" dialog) (colored highlighting of buttons 1 , 2 and 4) and the white illumination of buttons / legends (s. 6.5.4). |
| 6 |  | The squelch adjustment button contains two keys (+ and -). Pressing any of the two keys opens the dialog window for adjusting of the squelch level (s. 6.5.3). |
| 7 |  | Key without specific function. |
| 8 | 5" TFT full-color display | Shows the corresponding data content of the current page or dialog. |
| 9 |  | Hotkeys for activating variable functions. The assignment of the keys differs depending on the page or dialog. |
| 10 | Sensor of brightness | Measures the ambient brightness to automatically adjust the brightness of the TFT display, status keys (labeled "Keys" in the Adjust Brightness" dialog) and buttons/legends. |
| 11 |  | Returns one step back in a menu or leaves a dialogue or an adjusting field without storing changed parameters. |
| 12 |  | Confirms an input or selection. Leaves a dialogue or an adjusting field and stores changed parameters. |
| 13 |  | By pressing this button, the system returns to the bearing page from any other page or dialog, without storing changed parameters. |
| 14 |  | The arrow keys provide the navigation and selection within the menu or selection field. Furthermore, they allow increasing or decreasing of some values (e.g. squelch level). |



| | | |
|-----------|---|---|
| <p>15</p> |  | <p>Numeric keys for direct numeric input.</p> |
| <p>16</p> |  | <p>Navigation keys for switching between the pages. Within the “Setup” page, the navigation keys have different functions due to the large number of possible settings.</p> |

Table 3 Buttons and display

5.3 Rear View

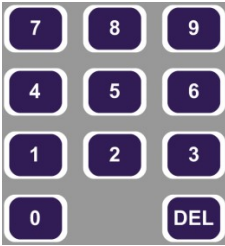
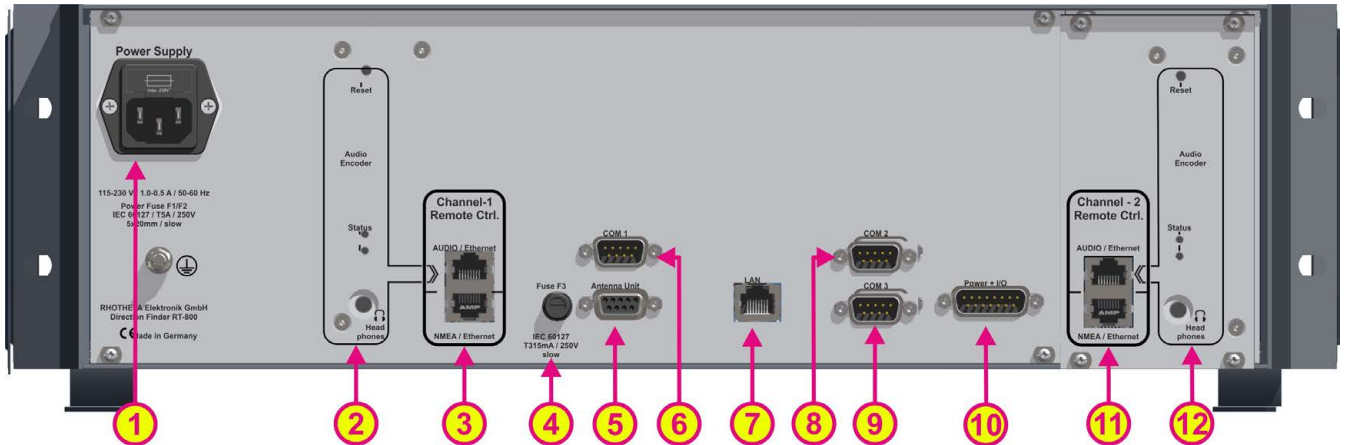

Fig. 3 Rear view

| Rear Elements | | |
|---------------|---------------------------------|---|
| Pos. | Element | Function Description |
| 1 | Power Supply | Power supply connector with replaceable fuse |
| 2 | IP-Audio Encoder (Channel-1) | Audio Output for DF and encoder configuration |
| 3 | Remote Control Channel-1 (MOXA) | <p>Ethernet ports for remote control (NMEA / Ethernet) and IP-Audio (AUDIO / Ethernet) using MOXA device (for more information s. chapter 8).</p> <p>Using the remote control via MOXA allows changing of IP data remotely and offers the possibility of setup the SNMP monitoring for RT-800 if needed.</p> <p>Note</p> <p>It is possible to use the MOXA or LAN DCU (s. 7) for remote control. If used simultaneously, use different network IP settings. For MOXA configuration (s. chapter 8). For LAN DCU configuration s. 6.4.4.2 and 6.4.4.3.</p> |
| 4 | Fuse F3 | Fuse for AU and COM ports (IEC 60127, T315mA / 250V, slow) |
| 5 | Antenna Unit | <p>Connector port for antenna unit (AU)</p> <p>Connection between DCU and AU via cable</p> <p>For more information s. chapter 7.2.</p> <p>Note</p> <p>The RT-500-M antenna unit is not compatible with the RT-800 direction finder and vice versa.</p> |

| | | |
|----|------------------------------|---|
| 6 | COM 1 | <p>Communication port NMEA 0183 Bus (RS422 / RS232):</p> <ul style="list-style-type: none"> • Connection for input of external data, such as compass, GPS, remote control, etc. • Connection for output of bearing data, e.g., for map plotter, PC etc. <p>When connecting to input use either RS232 Rx or RS422 Rx (not both)!</p> <p>For more information s. chapter 7.3.</p> |
| 7 | LAN | <p>LAN connector for network communication</p> <p>Also, please s. 3.</p> <p>For more information s. chapter 7.4 (available over DCU Settings).</p> |
| 8 | COM 2 | <p>Communication port NMEA 0183 Bus (RS422 / RS232), functions same as COM 1 (s. 6).</p> |
| 9 | COM 3 | <p>Communication port NMEA 0183 Bus (RS422 / RS232). This communication port is internally connected to MOXA for remote control purposes.</p> <p>Note Please do not use this port for other purposes or disconnect MOXA, if MOXA is used for remote control.</p> |
| 10 | Power + I/O | <p>Source connector:</p> <ul style="list-style-type: none"> • Connection for power supply • Connection for external speaker • Connection for self-bearing suppression (SBS / PTT) • Connection for audio line out • Contacts for alarm relay • Contacts for squelch out <p>For more information s. chapter 7.1.</p> |
| 11 | Remote Control Channel-2 | <p>Option: "2nd Channel Remote Control"</p> <p>Ethernet ports for remote control (NMEA / Ethernet) and IP-Audio (AUDIO / Ethernet)</p> <p>Note Please do not use LAN, if 2nd channel is used. LAN DCU is then not connected internally.</p> |
| 12 | IP-Audio Encoder (Channel 2) | <p>Option: "2nd Channel Remote Control"</p> <p>Audio Output for DF and encoder configuration</p> |

Table 4 Rear elements

6 Operation

The RT-800 is operated from the control panel (display unit) using the keys placed around the display.

In normal bearing mode, the keys call up common functions directly, opening the corresponding dialog window.

The basic structure of a page is as follows:

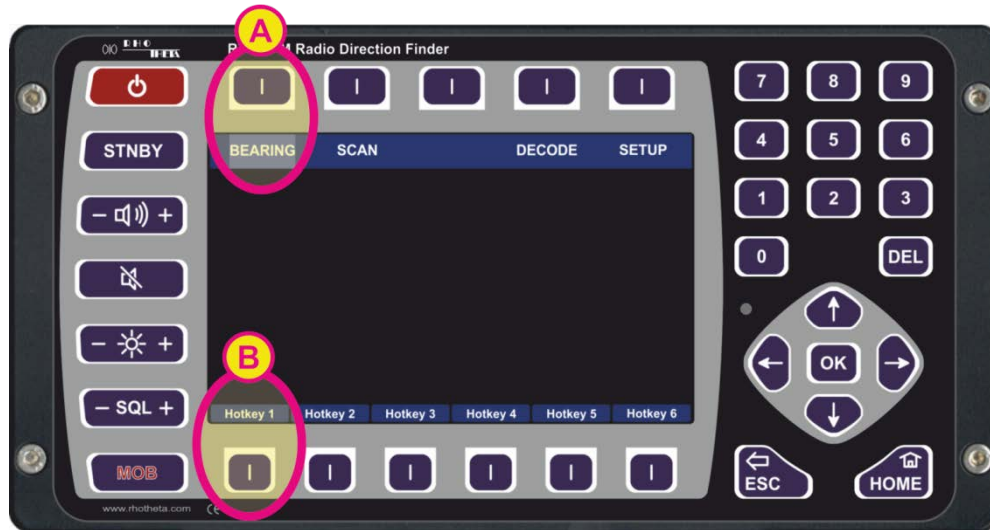

Fig. 4 Basic structure of pages

The different pages are listed on the top line of the screen and the active page is highlighted in light blue. Switching between pages is done via the corresponding navigation keys, which are located directly above the page names (s. field "A", Fig. 4).

The top line of the screen is the same for all pages except the "Setup" page, which contains all the necessary system setup options.

The hotkeys differ from page to page to provide page-specific functions or settings. Activate the hotkey function or setting by pressing the corresponding hotkey (s. field "B", Fig. 4).

6.1 Bearing Page

The bearing page is the main page of the RT-800 display unit as it provides the bearing information, settings and status reports at a glance.

This page can be opened by pressing the button “HOME” from any other page or dialog.

6.1.1 Bearing Indication

The “Bearing” page has the following structure (s. Fig. 5).

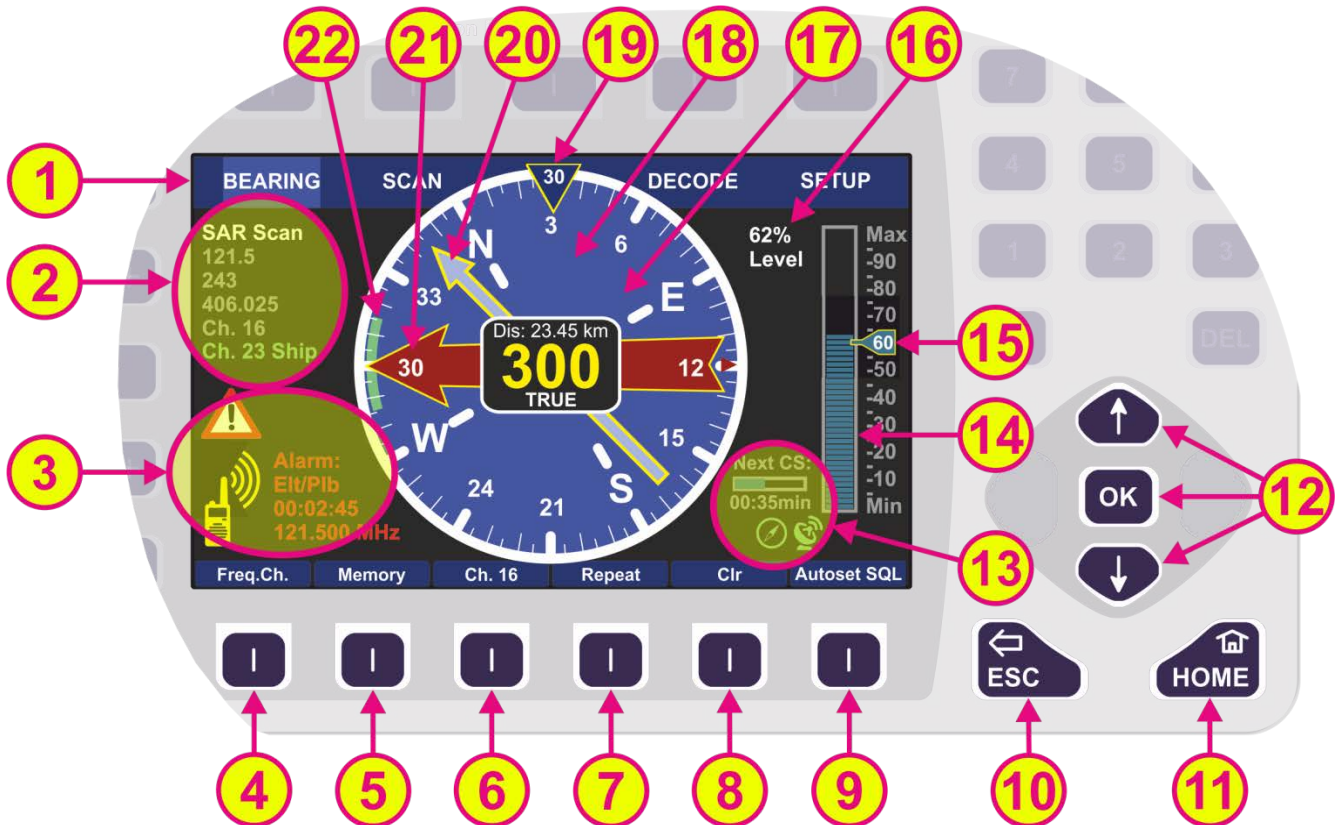
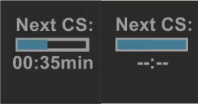





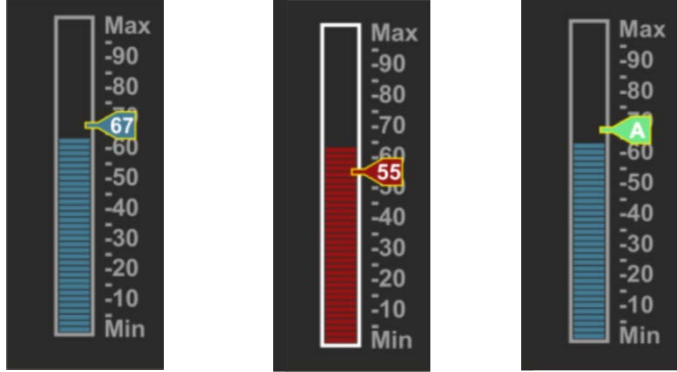



Fig. 5 Bearing display

Indication on Bearing Page

| Pos. | Element | Meaning / Description |
|------|----------------------|---|
| 1 | Top line | Navigation line of the screen, which allows switching between pages (“Bearing”, “Scan”, “Decode” and “Setup”). |
| 2 | Frequency indication | Section for frequency/channel indication during bearing and scanning. The active frequency is displayed in white color. If the scanning function is activated, the currently active frequency (or channel) is displayed in green, and the other frequencies, monitored by the scanning algorithm, are displayed in gray. If the “Repeat” hotkey (s. 7) is pressed, the old frequency value will also be shown in gray. If there is not enough space to show all frequencies, only a subset of the frequencies around the currently active frequency will be |

| | | |
|----|--------------------------------|--|
| | | displayed. |
| 3 | Alarms / Errors / Warnings | Section for indicating any faults in the system, alarms and/or warnings (s. 6.1.2.1). |
| 4 | Frequency / Channel hotkey | Pressing the “Freq.Ch.” hotkey will activate the frequency/channel input dialog (s. 6.1.2.2). If no input is detected for about 10 seconds, the dialog will be closed automatically. This waiting time can be changed in the “System” menu of the “Setup” page (s. 6.4.3.7). |
| 5 | Memory hotkey | Pressing the “Memory” hotkey will activate the memory dialog (s. 6.1.2.6). The memory dialog provides a list of saved frequencies or channels, which facilitates restoring any frequency from the list to the active bearing mode. Frequencies/channels (max. 8 frequencies) to be scanned in the mode “Fast Channel Scan” (available only with unlocked option), can be selected in the “Memory” dialog. |
| 6 | Channel 16 | Instant access to most common maritime emergency channel (or emergency frequency 121.500 MHz). |
| 7 | Repeat hotkey | Calls up last valid bearing, heading and level values. The last bearing clock in the lowermost line of the digital bearing display (s. Fig. 7) shows the time elapsed since the last valid bearing interruption. |
| 8 | Clear hotkey | Resets the internal value of the bearing averaging memory. Mutes the acoustic alarm (if such occurred, s. 6.1.2.1). |
| 9 | Autoset SQL / Squelch hotkey | Activates the automatic squelch level adjustment for the active frequency (for further information s. 6.1.6). |
| 10 | Escape button | Pressing this button while a dialog is open, will close the dialog without saving changes. If no dialog is open, pressing this button will go back to the last activated page. The “Bearing” page is the “end-point”. Pressing this button on the “Bearing” page will have no effect when no dialog is open. Monitoring/scanning operation will continue onto the next frequency/channel upon pressing the “ESC” button, if e.g. currently no data is being received on present frequency. |
| 11 | Home button | Pressing this button always leads to the “Bearing” page (home page) from any other page or dialog. If any scan is running, a dialog for leaving the scan will be opened when the “Home” button is pressed. |
| 12 | Arrows “Up” and “Down” and the | The squelch level of the main bearing frequency/channel can be adjusted manually by using the arrow buttons (this is only possible if the main frequency is active). If any scan mode is active, pressing one of these buttons will open the squelch dialog (s. 6.5.3). |

| | | |
|-----------|-----------------------------------|--|
| | <p>“OK” button</p> | <p>If no dialog is open, the “OK”- button will not have any effect on the “Bearing” page. Whereas inside a dialog this button is used to confirm an input and close the dialog.</p> |
| <p>13</p> | <p>Additional data indication</p> | <p>Section for indicating additional data, such as activated or deactivated additional hardware or elapsed time indication for the next awaited Cospas-Sarsat pulse.</p>  <p>This symbol indicates the time left until the next Cospas-Sarsat pulse. The small bar graph gets filled every second until the next Cospas Sarsat pulse arrives. If after one minute no Cospas-Sarsat pulse arrives, the bar graph will be filled out and show “--:--” for the time.</p>  <p>This symbol indicates a USB connection. If a USB stick is connected to the DCU, the USB symbol turns green. If there is no USB connection available, the symbol does not appear.</p>  <p>If this symbol is green, then there is valid heading data from an external compass present. If there is no valid heading data available, the symbol stays blue and crossed out.</p>  <p>This indicator shows whether there is valid position data from an external GPS available or not. If there is valid position data, the symbol turns green. Otherwise, the symbol stays blue and crossed out.</p> |
| <p>14</p> | <p>Indication of signal level</p> | <p>Current signal level (bar graph):</p> <ul style="list-style-type: none"> ○ Color “blue” means that the signal level is under the squelch threshold. ○ Color “red” means that the signal level is above the squelch threshold. ○ The bar graph has a numerical scale, showing the level either in [%] or in [dBm], which can be selected in the “Setup” menu. <p>See pictures below.</p> |

| | | |
|-----------|--|---|
| <p>15</p> | <p>Indication of squelch level</p> |  <p>Current squelch level in [%] or [dBm]:</p> <ul style="list-style-type: none"> The squelch level can be set manually. In this case the numerical value is shown inside the indicator.  No signal is received (squelch level > signal level). By pressing “Autoset SQL” (s. 9) the squelch level is set above the noise level by a defined value (only once every time this button is pressed). The indicator stays blue with the numerical value inside.  The signal is received (signal level > squelch level).  The option “Automatic SQL” is selected (no signal received).  The option “Automatic SQL” is selected (signal is received). The squelch level will be held continuously at the best position over the noise. If set to automatic, the indicator turns green and shows an “A” instead of the numerical value. |
| <p>16</p> | <p>Digital signal level indication</p> | <p>Signal level of active bearing frequency / channel in [%] or [dBm] (adjustable in the “Setup” page).</p> |
| <p>17</p> | <p>Digital bearing display</p> | <p>Indication of the bearing information:</p> <ul style="list-style-type: none"> Averaged bearing value in degrees as a three-digit number in the middle of the display Reference of the bearing (“True”, “Magnetic” or “Relative”) The last bearing clock is shown in the lowermost line of the digital bearing display (s. also Fig. 7) if the bearing signal has disappeared. The clock counts the time elapsed since the signal was lost. The indication is in [hh:mm:ss]. Distance from the current GPS position to the stored GPS position is shown in the uppermost line of the digital bearing display. This information is only indicated, if GPS data is available and at least one GPS arrow is displayed (Decode mode). If there is more than one GPS arrow, only the distance to the closest coordinates will be shown. |

| | | |
|----|--|--|
| | | <p>The indication is in [km] or [NM], depending on the configuration in the “Setup” menu or configuration file.</p> <ul style="list-style-type: none"> ○ GPS True Bearing: indication in degrees Shows the calculated bearing angle from the current GPS position to the stored GPS position. This information is only indicated if GPS data is available. ○ If a PTT (push to talk/self bearing suppression) signal has been detected and PTT is activated for the current frequency (“Setup” page), the letters “PTT” will be shown instead of the reference direction (e. g. “TRUE”) and the bearing value (e. g. “300”) will be replaced by “---”. |
| 18 | 360° display and compass rose indication | <p>Without compass data (bearing reference direction RELATIVE) the relative bearing will be shown in the 360°-display.</p> <p>If the antenna is mounted correctly, the 0°-value corresponds to the North alignment of the antenna (for mobile use this value corresponds to the longitudinal axis of the vessel/vehicle).</p> <p>If compass information is available, the graphic display of the bearing value will be shown within the compass rose, for the bearing reference directions TRUE or MAGNETIC (s. under Setup -> Display settings).</p> |
| 19 | Heading pointer | <p>Heading direction indicator.</p> <p>If “Compass” is used as “Bearing Scale Orientation” (s. under Setup/Display settings), the heading pointer shows a value in [°] (here: “30”). In this case, please ensure that the compass orientation matches with the antenna orientation.</p> <p>Heading pointer is fixed in the 12 o’clock position and displays the heading value, if compass information is available.</p> <ul style="list-style-type: none"> ○ If the “Bearing Reference Direction” is set as “True bearing” (s. under Setup/Display settings), then the heading direction is shown relatively to the true (geographic) North Pole direction. ○ If the “Bearing Reference Direction” is set as “Magnetic bearing”, the heading direction is shown relatively to the magnetic North Pole direction. ○ If the “Bearing Reference Direction” is set as “Relative bearing”, the heading pointer takes the zero-value. This indication stays constant. <p>Note If the “Relative Bearing” reference direction is chosen under “Setup/Display”, but valid compass data is available, the heading value will change according to the compass data.</p> <p>If “Static (North Up)” is used as “Bearing Scale Orientation” (s. under Setup/Display settings), the indication inside the heading pointer will be “N up” regardless of the “Bearing Reference Direction”.</p> |

| | | |
|----|-------------------|---|
| | | The 360° display/compass rose stays fixed in this position also regardless of the “Antenna North Adjustment” setting (s. under Setup/System). |
| 20 | GPS arrow | The GPS arrow relates to the GPS position. Therefore, this indication is only possible, if GPS data is available. This indication can be activated for pointing to GPS coordinates that were decoded from Cospas-Sarsat messages on the “Decode” page (gray arrow). For more information s. chapter 6.3. |
| 21 | Bearing arrow | The bearing arrow is the graphical indication of the bearing value on the 360° display/compass rose. The bearing arrow additionally displays the opposite direction on the compass rose. The bearing value can be indicated (s. also 19): <ul style="list-style-type: none"> ○ Relative to the North / 0° marking of the antenna respectively heading of the vessel. This is the case if no external compass is used. ○ Relative to the magnetic north pole ○ Relative to the true (geographical) north pole |
| 22 | Spread of bearing | Maximum deviation of unaveraged single bearing values. |

Table 5 Bearing page indication

6.1.2 Bearing Operation

Once the bearing frequency and the squelch level are set, the bearing operation starts. If a signal on the selected operating frequency/channel is received, its level will be indicated digitally in the range of 0% to 99% in the section for signal level indication besides the bar graph, which additionally represents the signal level in a graphical way (s. positions 14 and 16 in Fig. 5). The squelch level will then be pictured on the scale of the signal level indication at the manually (or automatically) adjusted value (s. position 15 in Fig. 5).

The bearing electronics will process data only if the signal level is above the selected **squelch level (= noise suppression)**. Even without a received signal the DF-system may display a certain signal level (**= noise**). To avoid distractions from environmental noise signals, the squelch level must be set above the noise level. For the correct setting of the squelch level, please pay attention to chapter 6.5.3.

The DF-system detects about 280 bearing values per second. These bearing values might vary significantly, depending on signal quality (signal strength and modulation). This range of spread is indicated as a green arc on the 360° display in front of the bearing arrow (s. position 22 in Fig. 5). The smaller the arc, the better the signal quality. If the signal quality deteriorates, the arc becomes larger.

The bearing electronics process the detected bearing values over a certain time interval using a sophisticated internal algorithm, which provides a steady and reliable indication of the bearing value (e.g. the bearing arrow does not react to fast-changing reflections and noise signals). This averaging procedure produces good bearing results, even if there is a wide spread of single bearing values.

The bearing arrow represents the **relative bearing value**. This value is always relative to some fixed point, which could be either heading (e.g., the bow-of-the-vessel direction in the

mobile application, presupposed the antenna is installed correctly) or one of the north pole positions (magnetic or geographic):

- in a fixed antenna installation (presupposed the antenna is installed correctly to the magnetic or geographic North Pole)
- with compass information via NMEA interface (please ensure that the compass orientation matches with the antenna orientation).

If using the heading of the vessel/vehicle as the reference direction (mobile use, no compass data available), the bearing will be shown on top of the 360° display. If using one of the North Pole directions, the bearing will be shown on the 360° display with additional indication of the cardinal points (compass rose).

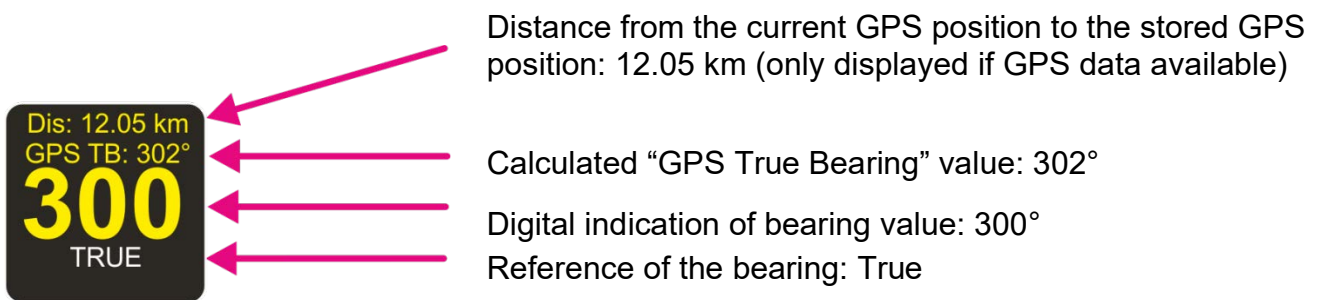

Fig. 6 Digital bearing display (active signal reception)

The digital bearing indication is a 3-digit number, rounded to the nearest degree. The reference of bearing is summarized again in the following table (s. Table 6).

| Bearing reference directions | | |
|------------------------------|--|---|
| Indication | Direction of Reference | Meaning |
| TRUE | True north pole | Bearing relative to true (geographic) North Pole. This is the case, if an external compass transmits true heading data (e. g. NMEA sentence "xxHDG" with valid variation or "xxHDT" sentence). |
| MAGNETIC | Magnetic north pole | Bearing relative to magnetic North Pole. This is the case, if an external compass is connected and transmits only magnetic heading (e. g. NMEA sentence "xxHDG" without valid variation). |
| RELATIVE | <ul style="list-style-type: none"> • North alignment of the antenna (in fixed installations) • Heading of the vessel/vehicle (in mobile use) | <p>This is the case if no external compass is used.</p> <p>Bearing relative to the heading of the vessel/vehicle or relative to the antenna North-direction.</p> |

Table 6. Bearing reference directions

If the signal stops being received, the last bearing value will be displayed as a transparent arrow for two seconds (default time value). This value is called “Bearing Hold Time” and can be changed in “Setup” (s. 6.4.2.1).

After 2 seconds, the arrow will disappear, and the time elapsed after the last signal reception will be shown inside the digital bearing display as “LB” (s. Fig. 7).

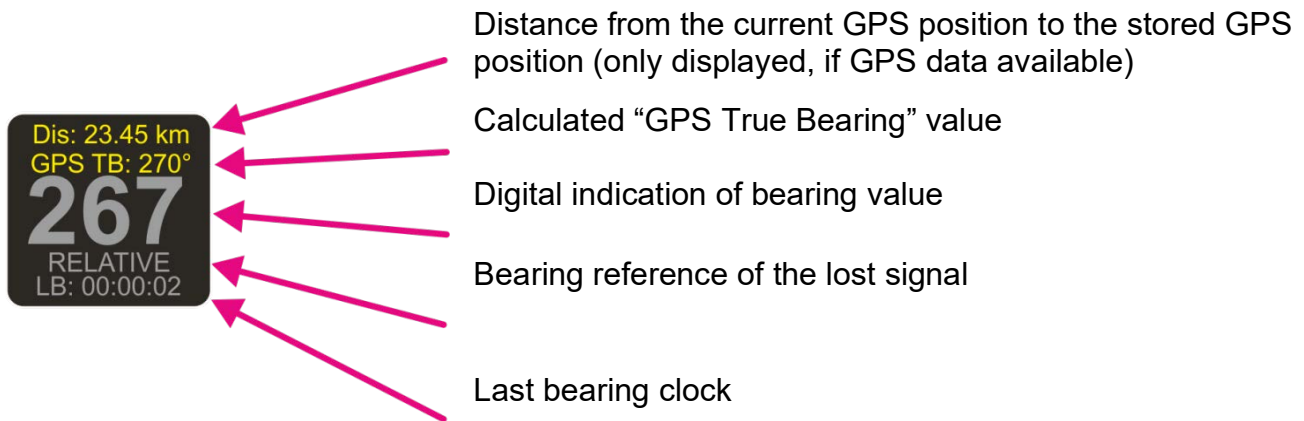

Fig. 7 Digital bearing display
(signal reception ended 2 seconds ago)

It is possible to show the arrow of the last bearing again by pressing the “Repeat” hotkey (s. position 7 in Fig. 5). The arrow will be displayed again for the time that has been set under “Bearing Indication Hold Time” in “Setup” (s. 6.4.2.1).

6.1.2.1 Alarms, Errors, Warnings

If during the operation either an emergency signal occurs, or an error is detected, or operating parameters exceed their specified limits, the system will inform the operator by activating an alarm-, error-, or warning-indication.

While a signal is being received (signal level > squelch level), it is examined in the background to determine if it is a modulated emergency signal. The emergency signals (ELT = Emergency Locator Transmitter, PLB = Personal Locator Beacon) are modulated with a typical repeating and distinct sweeping tone. Once recognized as an emergency signal, the alarm will be activated.

In addition to the graphical indication, a special internal warning tone will inform the operator about the reception of the emergency signal. The acoustic alarm will remain activated (even after the signal reception has ended) until confirmed or deactivated (hotkey “Clr”, s. position 8 in Fig. 5). If no emergency signal is received for more than a minute, the alarm will be canceled automatically.

Note

The alarm relay output will be activated as well when recognizing an emergency signal. Like the internal warning tone, the relay output can be deactivated by pressing the hotkey “Clr”. The alarm relay output may be used for an external siren or similar.



| Alarms/ Errors/ Warnings | |
|---|---|
| Indication Example | Meaning |
|  | <p>Alarm: An emergency signal has been detected. The source, the counter of the elapsed time since the last alarm, and the related frequency are shown beside the actual alarm indication.</p> <p>The hotkey “Clr” deactivates the warning signal and the alarm relay output.</p> |
|  | <p>Error: An error message will be displayed if:</p> <ul style="list-style-type: none"> ○ one or more operating parameters are out of the admitted limits ○ the system has recognized a malfunction (in this case the system is not working) <p>The hotkey “Clr” deactivates the acoustic warning.</p> |
|  | <p>Warning: The system indicates a warning, if:</p> <ul style="list-style-type: none"> ○ external signals are not available (anymore) ○ operating parameters are close to the tolerable limits <p>The warning means that the system’s basic functions are not affected yet, but it is recommended to check the system in order to prevent damages.</p> |

Table 7. Alarms, Errors, Warnings

6.1.2.2 Frequency / Channel Input Dialog

The frequency input dialog is called up by pressing the hotkey “Freq.Ch.” (s. Fig. 5, position 4) while the “Bearing” page is active.

The frequency input dialog appears in three variants with different input dialogs for:







- Frequencies (s. 6.1.2.3)
- Channels (s. 6.1.2.4)
- Cospas-Sarsat frequency groups (6.1.2.5)

The confirmed input of the dialog is displayed and stored, so after pressing the “Freq.Ch.” hotkey later again, the dialog opens with the last activated dialog variant (“Frequency Input” or “Channel Input”).

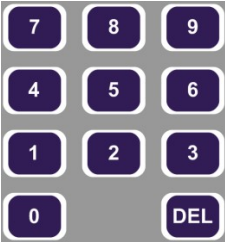
If no input is detected for 10 seconds (default value), the dialog will be closed automatically. This input time can be changed in the “Frequency Input Dialog Time” setting (s. 6.4.3.7).

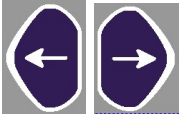
The following table explains the use of the keypad elements in the “Frequency/Channel Input” dialog.

List of Elements

| Element | Function |
|---|---|
|  | <p>Numeric keys for direct input of the frequency or channel number</p> <p>Note The input of invalid or not licensed frequency values will not be accepted.</p> |
|  | <p>This button deletes all digits in the input field.</p> |
|  | <p>The arrow buttons “up” and “down” allow the input of the frequency/channel, using a sophisticated input scheme.</p> <p>In the dialog variant selecting Cospas-Sarsat frequency groups, the “up” and “down” arrow buttons are used to select the desired frequency group.</p> |
|  | <p>These buttons are used to navigate from one digit to another inside the input field for new frequency/channel.</p> |
|  | <p>If the input of the frequency/channel is complete and valid, pressing this button saves the new value as “standby” frequency/channel.</p> <p>If the input is not correct, the system informs about it with following warnings:</p> <ul style="list-style-type: none"> ○  Ch. Spacing This indication appears for marine band frequencies, when the entered frequency is not in the typical grid (step width) but is still valid. ○  out of range This indication appears when the entered frequency is out of the reception range of the direction finder. ○  not valid This indication appears when the entered frequency is: <ul style="list-style-type: none"> ▪ not in the allowed grid (step width) of the corresponding band ▪ currently locked (s. 6.4.1.8) |



| | |
|---|--|
| |  <ul style="list-style-type: none"> ○ This indication appears when the entered frequency belongs to the optional extended range that is not licensed in the given direction finder system (s. Table 1). <p>In the drop-down menu for Selecting Cospas-Sarsat Frequency Groups, pressing this button selects the currently marked frequency group.</p> |
|  | Pressing this button closes the dialog without adopting values. |
|  | Pressing this button closes the dialog without adopting the values and opens the “Bearing” page. |
| “Frequency” | This hotkey opens the dialog variant for frequency input (s. 6.1.2.3) |
| “Channel” | This hotkey opens the dialog variant for channel input (s. 6.1.2.4) |
| “Ship” | This hotkey appears only for duplex channels (s. Fig. 10) in the dialog for channel input. It allows selecting the “Ship” frequency for a duplex channel. |
| “Coast” | This hotkey appears only for duplex channels (s. Fig. 10) in the dialog for channel input. It allows selecting the “Coast” frequency for a duplex channel. |
| “CP/SS” | This hotkey opens the dialog variant for selecting Cospas-Sarsat frequency group (6.1.2.5). |

Table 8. Frequency input dialog. List of elements

6.1.2.3 Input of Frequencies

Two ways of entering a new frequency are possible in the frequency input dialog:

- 1) input using the numeric buttons, and
- 2) input using the arrow buttons.

The “Frequency/channel input dialog” is divided into:

- Section “Active... [MHz]”, which shows the currently active frequency (s. Fig. 8, field A).
- Section “Standby ... [MHz]”, which allows the input of a new frequency (s. Fig. 8, field B).

Note

The frequency, which is simply typed in, is not immediately set to the “Standby”.
To set the new value to “Standby” value, press “OK”.

- “SWAP” function (s. Fig. 8, field C and position 3) allows switching between the two displayed frequencies.

Thus, one of them is always active and the other one can be set to “active” at one button press, whereby the previously active frequency becomes the “standby” frequency instead.

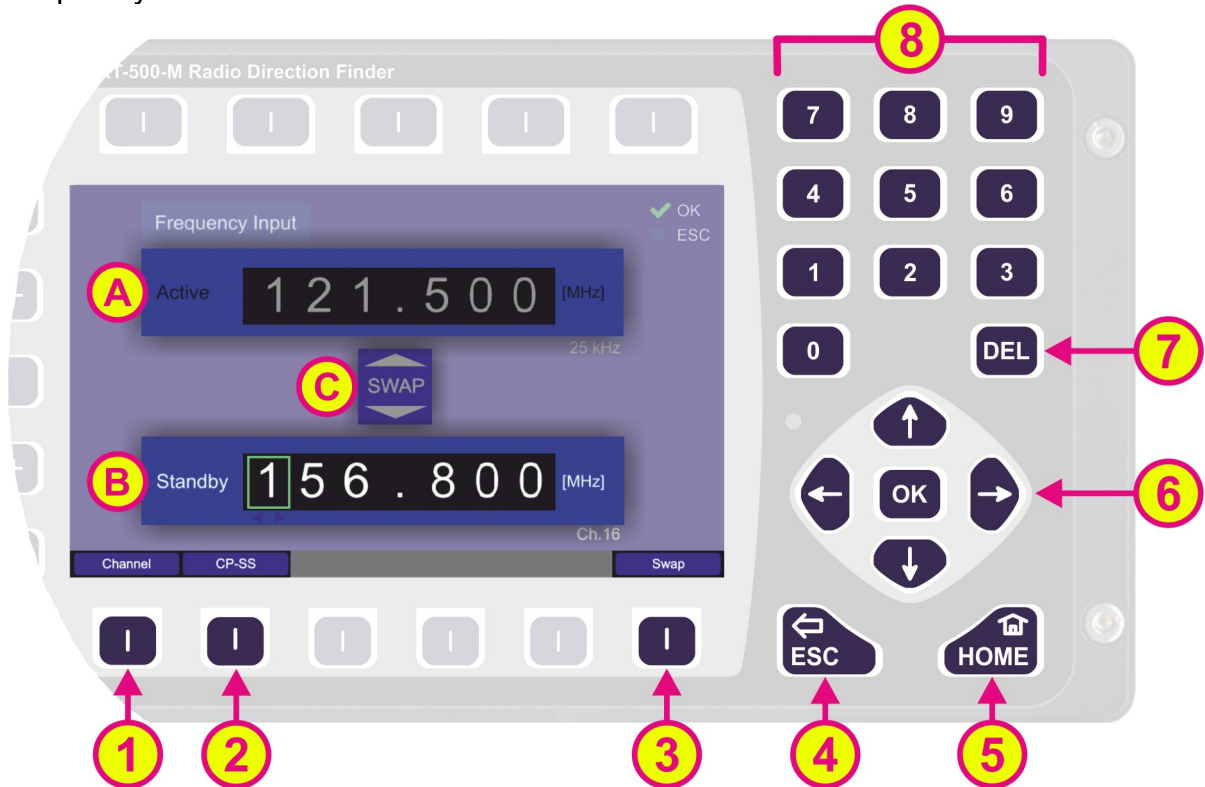

Fig. 8 Input of a new frequency

The currently selected digit is indicated by a green-colored frame.

The input of digits can be done with the numerical buttons on the front of the device (s. Fig. 8, field 8).

The arrow buttons “up” and “down” (s. Fig. 8, field 6) allow the input of the frequency/channel, using a sophisticated input scheme. Depending on the other digit values, that are already set, the system allows the selection of only correct numbers for the current digit.

Note

If the system does not allow entering the desired number for a current digit, control other digits in the input field and correct them if necessary. The system shows you, which digit is wrong by flashing the cursor-frame in red.

Note



Frequency step width depends on the selected frequency band (s. 9.1):

| | |
|---------------------|---------------------------------------|
| UHF / VHF Air Band: | 25 kHz / 8.33 kHz (s. Appendix, 13.7) |
| Marine Band: | 5 kHz |
| COSPAS-SARSAT: | 8.33 kHz |
| UHF FM Band: | 5 kHz |

Note

The input of invalid or not licensed frequency values will not be accepted.

Following actions are possible:

- Pressing  skips to and marks the next digit, left to the previous one.
The button  returns to the previous digit position / marks the next digit to the right.
- The “DEL” button (s. Fig. 8, position 7) deletes the whole input.
The input field shows “---.---”.
- Pressing the “OK” button (s. Fig. 8, field 6) adopts the frequency value as the new “Standby” value. This is not possible until the input is complete and valid from the first to the last digit (s. warnings in Table 7).

Note

After the new value for frequency was adopted, the second pressing of the “OK” button will not have any effect. To return to the “Bearing” page, use either the “ESC” or “HOME” button (s. below).

- Pressing “Swap” hotkey (s. Fig. 8, position 3 and field C) sets the “standby” frequency to the active bearing frequency and the previously active frequency is set to “standby” (s. Fig. 9).

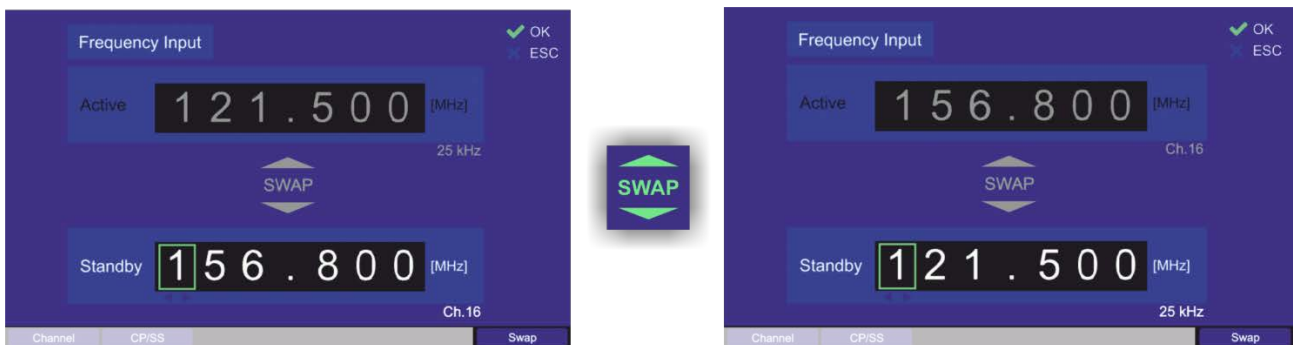

Fig. 9 Swap frequencies

If you press „Swap” hotkey again, the frequencies will switch back.

- Pressing the “CP/SS” hotkey (s. Fig. 8, position 2) opens the dialog variant for selecting “Cospas-Sarsat” frequency groups (description s. 6.1.2.5).
- Pressing the “ESC” button (s. Fig. 8, position 4) closes the dialog without saving changes.
- Pressing “HOME” button (s. Fig. 8, position 5) closes the dialog without saving changes and leads to the bearing page.

The corresponding channel spacing for the entered frequency is automatically shown in the right lower corner under the frequency input field. It is also shown for the active frequency.

For a valid input of a marine band frequency, the number of the corresponding channel is shown under the frequency input field in the right lower corner. It is also shown for the active frequency.

If a Cospas-Sarsat frequency is entered, the value will be automatically converted to an input in the 8.33 kHz grid (s. 6.1.2.5).

The inputs will be set to the following values:

406.025000 MHz = Channels: *A* (406.022 MHz), *B* (406.025 MHz), and *C* (406.028 MHz)
406.033333 MHz = Channels: *D* (406.031 MHz), *E* (406.034 MHz) and *F* (406.037 MHz)
406.041666 MHz = Channels: *G* (406.040 MHz) and *H* (406.043 MHz)
406.050000 MHz = Channels: *I* (406.046 MHz), *J* (406.049 MHz) and *K* (406.052 MHz)
406.058333 MHz = Channels: *L* (406.055 MHz), *M* (406.058 MHz) and *N* (406.061 MHz)
406.066666 MHz = Channels: *O* (406.064 MHz), *P* (406.067 MHz) and *Q* (406.070 MHz)
406.075000 MHz = Channel: *R* (406.073 MHz) and *S* (406.076 MHz)

Corresponding Cospas-Sarsat channels for the entered Cospas-Sarsat frequency are shown in the right lower corner of the “Standby” frequency field. They are also shown for the active frequency.

Note

The squelch level is set to 30% by default for the first input of the “Standby” frequency. After changing the squelch level, the new value is stored together with the corresponding frequency (active frequency with squelch / standby frequency with squelch). For Cospas-Sarsat frequencies the squelch is set to “Auto” by default. For more information about squelch s. 6.5.3.

6.1.2.4 Input of Channels

Generally, channel input works the same way as frequency input: the input dialog is divided into a section for the active channel and a section for the new channel (s. Fig. 8, fields A and B).

With the “swap” function the “standby” channel can be set to “active” and the currently active channel becomes “standby”.

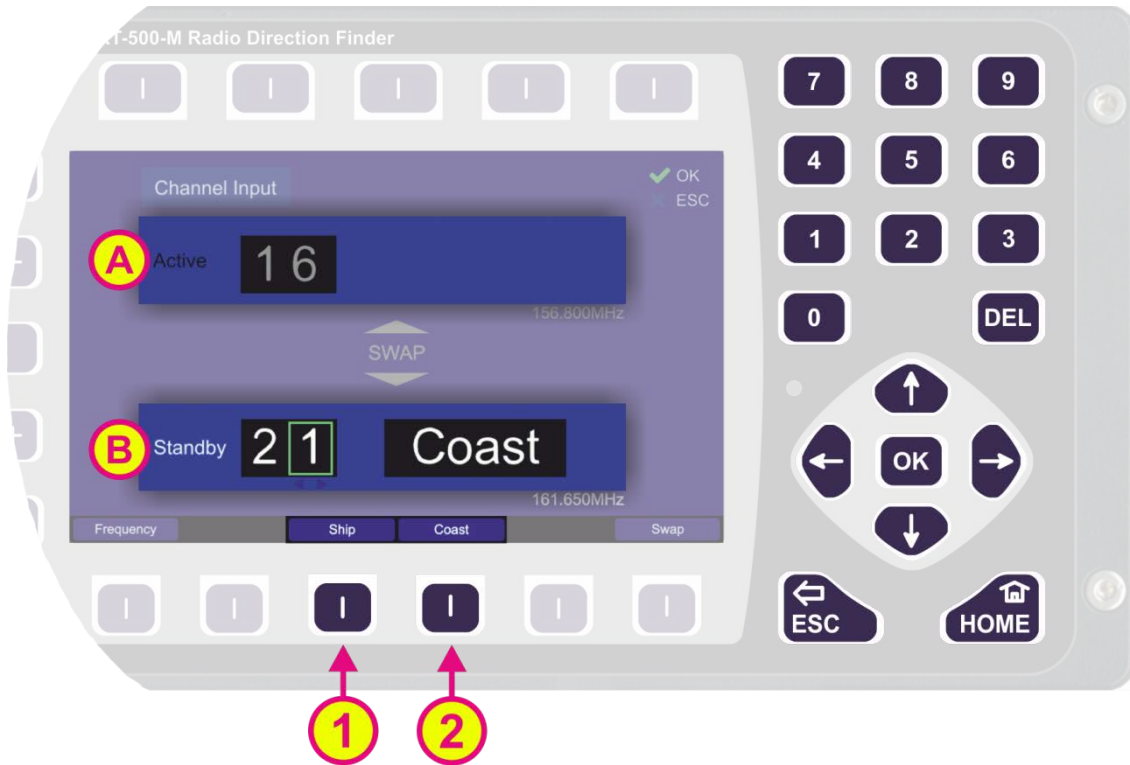

Fig. 10 Input of a new channel

However, there are two additional hotkeys: “Coast” and “Ship” (s. Fig. 10, positions 1 and 2), which allows switching between “ship”- and “coast”- frequencies in the case of a duplex channel. These hotkeys are only visible if there is a valid input for a duplex channel (e. g. the hotkeys will not be visible for an input “16”, as channel 16 is not a duplex channel). For the non-duplex channels, the new channel is entered as a number without any additional input.

Switching from “Channel” input dialog variant to “Frequency” input dialog variant while entering a channel number will have the following outcomes:

- If channel input is not completed, the frequency input dialog will show only the current frequency in the “Active” field.
- If all digits of channel input are entered and the input is valid, the frequency input dialog will show the new frequency (which belongs to the channel), in the “Standby” section.



Fig. 11 Changing from "Channel" to "Frequency" when channel input is complete

Switching from “Frequency” input to “Channel” input dialog variant when the “Standby” frequency does not belong to marine band, will show the empty “Standby” field and a warning (s. Fig. 12).

The warning will disappear as soon as a valid channel number is entered in the “Standby” field.

Changing back to “Frequency” input dialog variant from this view, the previously set standby frequency is displayed if no channel has been entered.

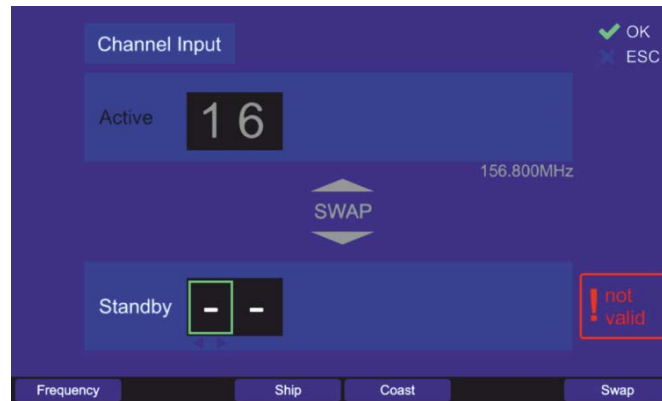

Fig. 12 Switching to "Channel" when "Standby" frequency = 121.500 MHz

Switching from “Frequency” to “Channel” input dialog variant when the “Active” frequency does not belong to marine band, will show the “Active” frequency in MHz and the “Standby” input field for the channel input (s. Fig. 13).

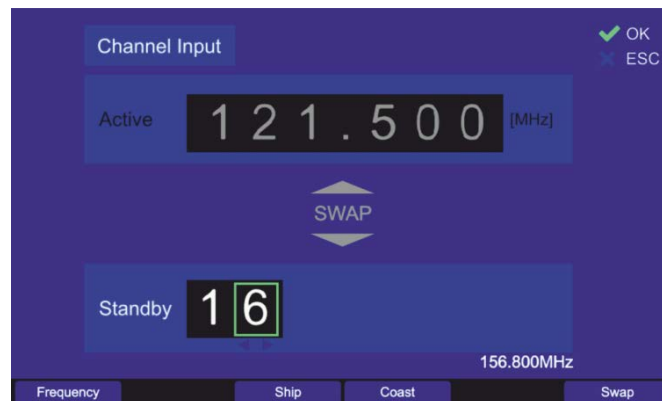

Fig. 13 Channel input with non-marine active frequency

6.1.2.5 Selecting Cospas-Sarsat Frequency Groups

The hotkey “CP-SS” (s. Fig. 8, position 2) opens a drop-down menu with selectable Cospas-Sarsat frequency groups. The currently active frequency group is highlighted in green, whereas the other groups are gray. By pressing the “up” and “down” arrows (s. Fig. 14, position 3), the green frame moves and marks next frequency group, which can be selected by pressing “OK”. Pressing “ESC” will close the dialog without adopting the new frequency.



Fig. 14 Input of a new COSPAS-SARSAT frequency

With hotkeys “Frequency” or “Channel” (s. Fig. 14, positions 1 and 2) the corresponding variant of the input dialog is selected.

As a result of the 8.33 kHz grid of the AU, after selecting any channel group, the indication on the “Bearing” page will be as follows:

- “406.025 MHz” for Channel ABC
- “406.033 MHz” for Channel DEF
- “406.042 MHz” for Channel GH
- “406.050 MHz” for Channel IJK
- “406.058 MHz” for Channel LMN
- “406.067 MHz” for Channel OPQ
- “406.075 MHz” for Channel RS

The corresponding Cospas-Sarsat channels for the entered Cospas-Sarsat frequency are shown in the right lower corner of the “Standby” frequency field. It is also shown for the active frequency.

6.1.2.6 Memory Dialog

The memory dialog (s. Fig. 5, position 5) provides a list of stored frequencies (channels), which facilitates restoring any frequency from memory to the active bearing mode.

Selection of the frequencies works by using the “up” and “down” arrows. Recalling the marked frequency into the active bearing mode is accomplished by pressing the button “OK”.

Furthermore, each frequency can be marked for the function “fast channel scan”, which means that by activating this function, the marked frequencies will be used for scanning. The fast scanning function itself is limited to a maximum of eight frequencies, so there is also a maximum of eight frequencies which can be marked for scanning in the “memory” dialog.

Inside the “memory” dialog, the sub-dialogs can be opened, e. g. frequency name editing dialog.





Note

The “List of stored frequencies” of the memory dialog is internally linked to the list of frequencies of “Fast Channel Scan” (s. 6.2.3.3). This only applies to frequencies that are marked for scanning (s. Fig. 15, “Scan”) in the memory dialog. This means that activating / deactivating or deleting a frequency in the memory dialog causes activating / deactivating or deleting the same frequency in the “Fast Channel Scan”-list.

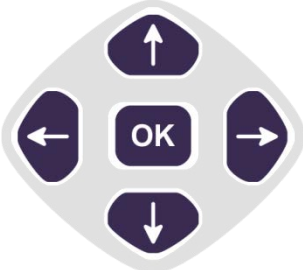

Fig. 15 Memory Dialog. Top level

| List of Elements | | |
|------------------|--------------|---|
| Pos. | Element | Function |
| ① | “New Freq.” | Creates a new entry at the end of the list. By pressing this hotkey, the “Frequency input dialog” opens immediately and the new frequency can be entered into the list. |
| ② | “Edit Freq.” | Pressing this hotkey opens the “Frequency input dialog” for changing the currently marked frequency/channel. |
| ③ | “Edit Name“ | Pressing this hotkey opens the virtual keyboard, which allows textual input of the name for the currently marked frequency/channel. |
| ④ | “Move Up” | By pressing this hotkey, the currently marked line will be moved one position upwards in the list. |
| ⑤ | “Move Down” | By pressing this hotkey, the currently marked line will be moved one position downwards in the list. |

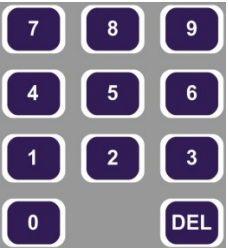
| | | |
|----|---|--|
| 6 | "Scan Yes/No" | <p>This hotkey marks the currently selected frequency for the function "Fast channel scan". That means, when "Fast channel scan" is activated, this marked frequency will be scanned as one of the eight possible frequencies for this scan function.</p> <p>If the frequency/channel is already marked for scan and the hotkey "Scan Yes/No" is pressed once again, the marking for "Fast channel scan" will be removed.</p> |
| 7 |  | <p>Pressing this button will close the dialog (or frequency / name input) without adopting the new values.</p> |
| 8 |  | <p>Pressing this button will close the dialog without adopting the values and open the "Bearing" page.</p> |
| 9 |  | <p>The "up" and "down" arrows are used to select between the stored frequencies in the "memory" dialog. When editing the name of a frequency, these buttons are used to navigate on the displayed keyboard.</p> <p>The "right" and "left" arrows are used to navigate on the displayed keyboard while editing the name of a frequency.</p> <p>Button "OK":</p> <ul style="list-style-type: none"> ○ On the top level of the "memory" dialog pressing "OK" will activate the currently marked frequency and close the dialog (previously used frequency on the "Bearing" page will be changed to the selected frequency). ○ In the sub-dialogs "New Freq.", "Edit Freq." and "Edit Name", pressing "OK" will confirm the edited values (frequency, entered letters or numbers, or the whole input). |
| 10 |  | <p>This button deletes the currently marked frequency from the list.</p> <p>Note Deleting the frequency from the list will follow immediately after pressing the "DEL" button, without asking for confirmation of the deleting procedure. Pressing the button "DEL" within the sub-dialogs "New Freq.", "Edit Freq." and "Edit Name" clears the input field (all digits).</p> |
| 11 |  | <p>The number keys can be used for inputting the frequency name (s. also 3, "Edit Name") since the names of frequencies may contain numbers and characters.</p> |

| | | |
|----|--------|--|
| 12 | "Save" | <p>Pressing the "down" arrow until the green frame reaches the "Save" button and confirming with "OK" will save all previously made modifications within the "memory" dialog (editing frequencies, names etc.). Once done, the dialog can be closed by pressing "ESC", all changes will remain saved.</p> <p>Using the "ESC" button without previously confirming the changes with "Save" will close the memory dialog without saving the changes.</p> |
|----|--------|--|

Table 9 Memory Dialog. List of elements

Edit Name Sub-Dialog

This dialog is opened from the top level of the "Memory" dialog by using the corresponding hotkey and allows editing the name for the marked frequency.

This dialog cannot be closed with the button "OK" because that button is used to confirm each individual character for the text input. The characters are selected by navigating on the virtual keypad using the arrow keys (s. position 3, Fig. 16). The dialog is closed by confirming with the button "End of User Input" on the virtual keyboard.



Fig. 16 Editing the frequency name

If the frequency name contains numbers, they can be entered using the number keys on the keypad (s. position 5, Fig. 16) since the virtual keyboard itself does not contain number keys. Using the "DEL" button (s. position 4, Fig. 16) the whole input will be deleted.

The arrow-keys **↑** **⇧** on the virtual keypad have the same function as "shift" and "caps lock" on a standard PC keyboard. The thick "up" arrow acts as "shift" (the next input will be interpreted as capital letter, but the following inputs are interpreted as lowercase letters unless this button is pressed again). The thin "up" arrow acts as "caps lock" (the following inputs will be interpreted as capital letters if the button is not pressed for the second time).

The “End of User Input” is used to confirm the whole text in the input field. By confirming this button with “OK”, the edit name sub-dialog will be closed, adopting the new name for the frequency which can be seen in the control field above (here: “Edit Name of Frequency” 121.650 MHz).

Pressing the “ESC” or “HOME” (s. positions 1 and 2, Fig. 16) will close the dialog without adopting the values (and open the “bearing” page in case of the “HOME” button).

6.1.3 Function Channel 16

Pressing hotkey “Ch. 16” (s. Fig. 5, position 6) enables instant access to maritime emergency channel 16.

If this function is activated, the hotkey name indication adopts the value of the previously active frequency, so that it can be quickly switched back if needed.

Note

Please verify correct squelch adjustment. For squelch adjustment see 6.5.3.

6.1.4 Function Repeat

Pressing the hotkey “Repeat” (s. Fig. 5, position 7) after a signal loss during the normal bearing operation shows the last valid bearing, reference and level values (s. Fig. 17, field B).

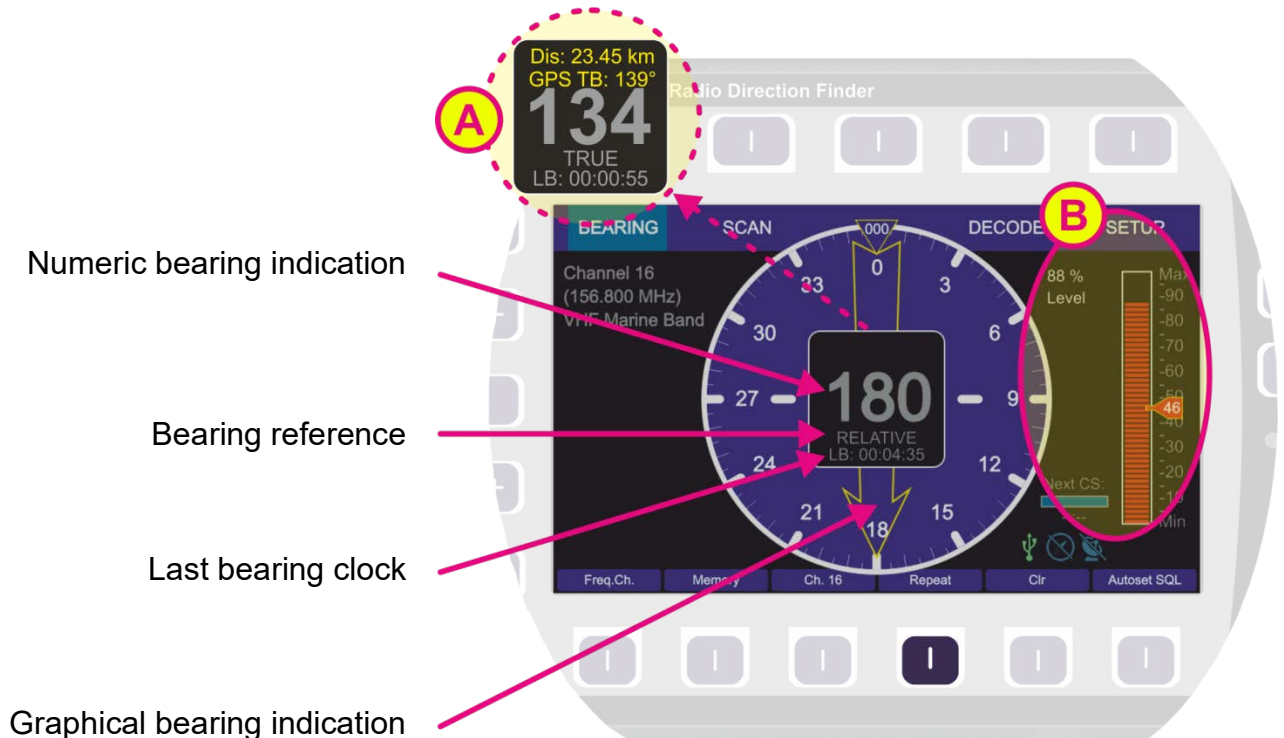

Fig. 17 Repeat indication

The last bearing clock in the lowermost line of the digital bearing display (s. Fig. 17) shows the elapsed time since the last valid bearing was interrupted/lost.

Depending on the availability of compass or GPS data, also other information can be displayed in the numeric bearing indication window (s. Fig. 17, field A).

The last valid bearing data will be shown for 2 seconds (by default) after pressing the “Repeat” hotkey. This hold time can be changed on the “Setup” page (“Bearing Indication Hold Time”, s. 6.4.2.1).

The repeat function during a scan is displayed differently depending on the current scan procedure.

For all scan procedures, except “SAR Scan”, “Fast Channel Scan” and “Monitoring”, the repeat function shows the information about the last valid bearing in the left upper corner of the DCU display e.g., as it is shown in the Fig. 39 in the chapter 6.2.4.

For “SAR Scan”, “Fast Channel Scan” and “Monitoring” the last result is shown in the digital bearing display (s. Fig. 17, digital bearing display indication with bearing arrow) and the corresponding frequency is marked with a gray circle, e.g.:

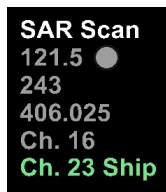

If a new signal is detected, the repeat indication interrupts and adopts the new bearing value. If an external compass is activated (“true” / “magnetic” bearing), a change in the heading of the ship is automatically considered for the bearing.

Note

If no external compass is activated (“relative” bearing), the indicated bearing value corresponds to the North/0° mark of the antenna (fixed installation) respectively vessel’s/vehicle’s heading at the time of the bearing (mobile installation). A change of heading in the meantime must be considered.

6.1.5 Function Clear

The function “Clr” (s. Fig. 5, position 8) clears the internal bearing value averaging memory.

The averaging memory improves the bearing accuracy and provides a useful bearing indication even with poorly received signals (e.g., distant transmitter, receiving gaps).

The averaging procedure can cause a dragged error, which might affect the bearing value, if the heading changes too fast¹. In this case, the indicated bearing value will slightly lag behind the actual bearing value.

Pressing the hotkey “Clr” after a distinct change of heading will correct the displayed bearing value immediately.

If an alarm was activated, this hotkey is used to mute the acoustic alarm (s. 6.1.2.1).

If the “GPS Arrow” was exported to the “Bearing” page (s. 6.3.5), keep the “Clr” hotkey pressed for a few seconds in order to remove the GPS arrow indication.

6.1.6 Function Autoset Squelch

In normal bearing mode (no scan active) the hotkey “Autoset SQL / Squelch / Automatic / Manual” hotkey is designated as “Autoset SQL” (s. Fig. 5, position 9). Pressing this hotkey will automatically set the squelch level above the noise level by 6 dB (this is a default value and can be modified in “Setup”, s. 6.4.3.13). A manual readjustment might be necessary (s. chapter 6.5.3).

¹ Typical case is a quick pass on the transmitter, which is in the near field of the DF-antenna.

When bearing a Cospas-Sarsat frequency this hotkey is designated as “Manual”/ “Automatic”, which allows switching between these squelch adjustment possibilities. For further information please refer to chapter 6.5.3.

If any scan algorithm is activated, this hotkey is designated with “Squelch”, or is empty (s. “Scan” page). Pressing this hotkey will open the squelch dialog to adjust the squelch levels for the different frequencies.

6.2 Scan Page

The “Scan” page enables starting scanning modes as simply and quickly as possible. Various scan modes are shown as a list with the currently activated mode highlighted in green. If no scan is currently active, all scan modes in the list are displayed in gray, where one of the scan modes is marked by a green frame.

The scan procedures can also be configured on this page.

If a scan procedure has been activated, all relevant data of the activated mode will be displayed after switching to the “Bearing” page.

Fig. 18 shows the most important elements of the “Scan” page.

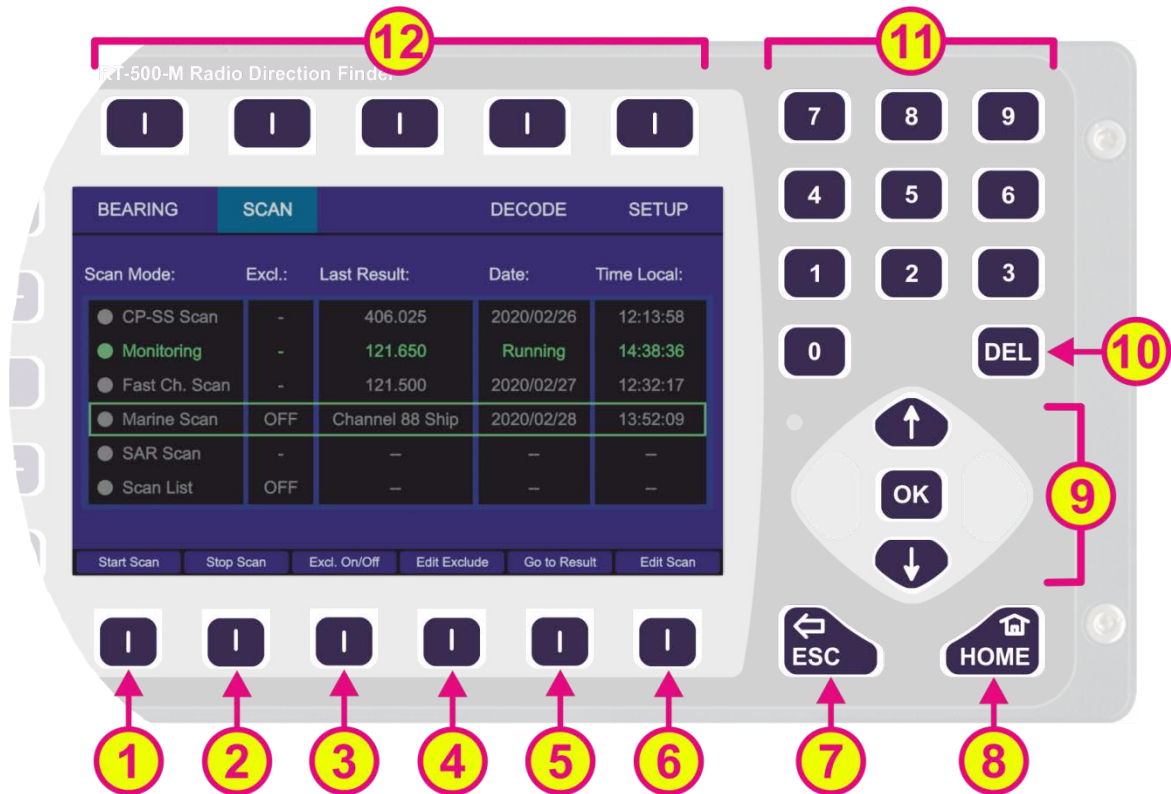

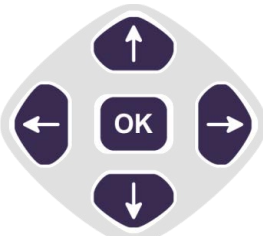



Fig. 18 Scan page. General view

| Indication on Scan Page | | |
|-------------------------|----------------|--|
| Pos. | Element | Meaning / Description |
| ① | „Start Scan“ | Activates the currently marked scan algorithm. On the “Setup” page you can set the behavior for when this hotkey is pressed (switching to the “Bearing” page or remaining on the “Scan” page, s. 6.4.3.14). |
| ② | “Stop Scan” | Stops the currently activated scanning algorithm, regardless of whether it is marked in the list or not. |
| ③ | “Excl. On/Off” | This hotkey appears only when the “Marine Scan” or “Scan List” is marked. By pressing this hotkey, the algorithm of the currently marked scan mode takes the “Exclude List” into account during the scan. If this setting was already activated for the currently marked |

| | | |
|----|---|--|
| | | scan, pressing this hotkey will deselect this option and the “Exclude List” will not be regarded during the scan. |
| 4 | “Edit Exclude” | This hotkey appears only when the “Marine Scan” or “Scan List” is marked. By pressing this hotkey, the dialog for editing the “Exclude List” is opened (s. 6.2.4.3). |
| 5 | “Go to Result” | Terminates the currently activated scan algorithm, acquires the frequency which was found during the last scan and switches to the “Bearing” page. If “Scan List” is marked, pressing this hotkey opens the corresponding dialog. This hotkey appears only if there is a result for the currently marked scan algorithm. |
| 6 | “Edit Scan” | Opens the dialog to edit the currently marked scan algorithm. |
| 7 |  | When there is a dialog opened, pressing this button will close the dialog without adopting new values. When there is no dialog opened, pressing this button will go back to the last activated page. The Bearing Page is the endpoint. |
| 8 |  | Pressing this button while on the “Scan” page will close the “Scan” page and open the “Bearing” page (home page). Pressing this button on the “Bearing” page while any scan procedure is currently active will open a confirmation dialog for ceasing the currently running scan procedure (s. Fig. 23). Confirming with “OK” terminates the scan operation and the system will change to the normal bearing mode on the previously selected frequency. By pressing the “ESC” the scan procedure will be continued. If a sub-dialog is opened, pressing this button will close it and lead to the “Bearing” page, without adopting the changed values. |
| 9 |  | “Up” and “Down” arrows are used to select between the general settings (move the green frame). Inside the dialogs (e.g. value editing) they are used to navigate between the characters of the virtual keypad. “Right and “left” arrows have no function on this page. If no scan mode is currently activated, pressing “OK” will activate the marked scan mode. With the “OK” button the confirming of values or opening the general settings dialogs is accomplished. If you want to use the frequency determined during the scan as the bearing frequency, press “OK”. This will quit the scan procedure and start the normal bearing mode on this frequency. |
| 10 |  | If any scan mode is currently activated, by pressing this button the scan mode will be stopped, regardless of whether it is |

| | | |
|----|---|---|
| | | marked in the list or not. Inside the settings dialogs, the “DEL” button is used to clear the whole input at once. |
| 11 |  | Numeric keys are used to enter the numerical characters inside the dialogs. On the top level of the “Scan” page, they have no function. |
| 12 | Top line | Navigation line of the screen, which allows switching between setup menus (“Bearing”, “Scan”, “Decode” and “Setup”). |

Table 10 Scan page. List of Elements

The last result, which was found during the last scan is displayed with frequency/channel, day and time besides the scan mode (s.Fig. 19, field A). This allows the direct opening of a frequency for bearing, which was found in an earlier scan cycle.

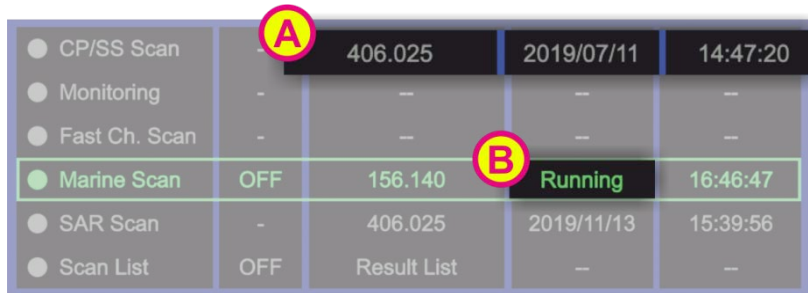

Fig. 19 Cospas-Sarsat scan mode with the last result indication

During any scan is active, the field for the day indication shows “Running” instead of the actual day indication (s. Fig. 19, field B).

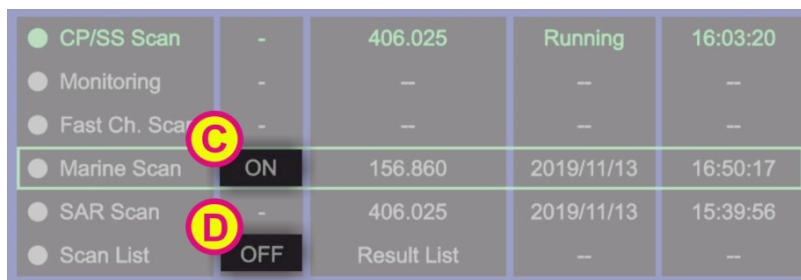

Fig. 20 "Exclude List" use indication

Further, if the “Exclude List” is used for a scan algorithm (only for “Marine Scan” and “Scan List” available), this will be shown in the table in the second column as “ON” (s. Fig. 20, field C). If the “Exclude List” is not used, it is marked with “OFF” (s.Fig. 20, field D).

6.2.1 COSPAS-SARSAT Scan

In this scan mode, the direction finder keeps scanning the entire COSPAS-SARSAT range of channels (s. 6.1.2.3 and 6.1.2.5) until a signal is detected on one of the channel groups (s. Fig. 21, field A).



Fig. 21 Cospas-Sarsat Scan indication on the "Bearing" page

After a Cospas-Sarsat frequency has been detected, the scan mode stops automatically and the direction finder changes to the normal bearing mode on this frequency (s. Fig. 21, field B).

- To start the "Cospas-Sarsat Scan" mode select the corresponding line on the "Scan" page and press "OK" or the hotkey "Start Scan" (s. Fig. 22, position 1)

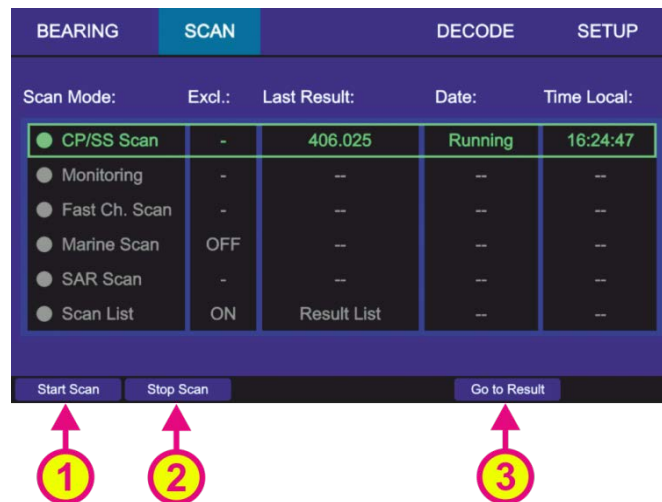

Fig. 22 "Cospas-Sarsat Scan" mode has been activated

- Pressing the hotkey "Stop Scan" (s. Fig. 22, position 2) will terminate the current scan mode and change to the bearing of the frequency, that was set before the scan mode has been activated.

Note

You can also stop the scan mode by pressing the "HOME" button on the "Bearing" page with activated scan. After you have confirmed the special dialog (s. Fig. 23), this mode will be terminated.

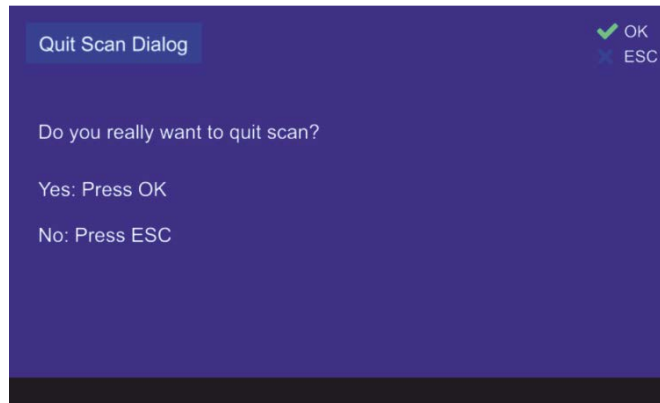

Fig. 23 Confirming of leaving the scan mode

- Pressing the hotkey “Go to Result” (s. Fig. 22, position 3) during the Cospas-Sarsat scan is running, will terminate the scan mode, adopt the frequency which was found in this scan last time and change to the “Bearing” page.
Pressing the hotkey “Go to Result” if the scan mode is not activated, will lead to the “Bearing” page with the last result as the activated frequency.
This hotkey appears only if there is a result for this scan.

6.2.2 Monitoring

The DF-system RT-800 can receive only one frequency at a given time. For simultaneous surveillance of the emergency frequency and any other frequency/channel, this monitoring function can be used.

Note

COSPAS-SARSAT frequencies cannot be set as the monitoring frequencies, but they still can be used as the main bearing frequency.

Monitoring scan has two different modes of operation, which depends on the main bearing frequency:

- Monitoring (normal): the mode of operation with any main frequency that does not belong to the COSPAS-SARSAT band.
- Monitoring CP-SS: the mode of operation with a COSPAS-SARSAT frequency as the main frequency.
This particular scan mode is convenient for the use case when the expected COSPAS-SARSAT frequency of a particular emergency beacon is not known and should be determined.
If the exact COSPAS-SARSAT frequency is known, then using the “SAR Scan” (s. 6.2.5) might be a better choice for simultaneous surveillance of several frequencies.

The surveillance of up to five different frequencies (within the specified frequency bands) is possible:

- One main bearing frequency
- And four monitoring frequencies:
The emergency frequencies 121.500 MHz and 243.000 MHz are stored permanently in the “Monitoring” algorithm.
Two more frequencies/channels can be set additionally in this scan (s. Fig. 24).

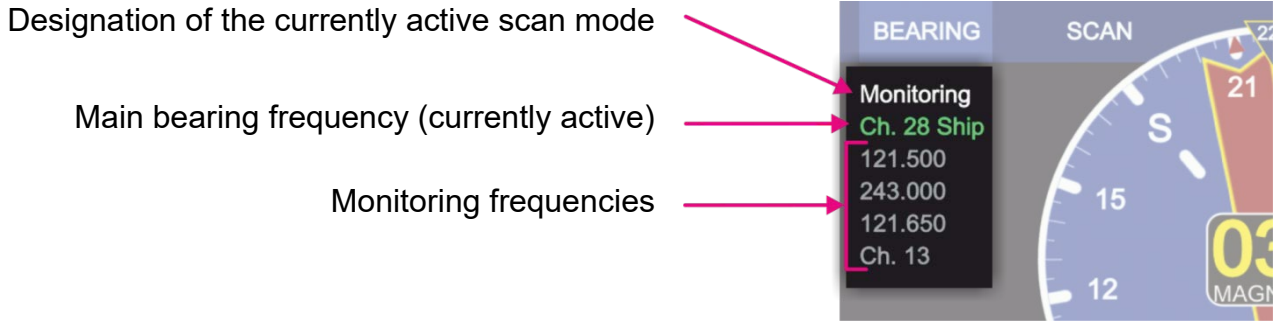

Fig. 24 “Monitoring” mode. Indication of frequencies

If the Monitoring (normal) function is activated, the DF system switches alternating from the main bearing frequency to the selected monitoring scanning frequencies (s. 6.2.2.1). The currently monitored frequency is displayed highlighted in green, so you can see, which frequency is active at a given moment (s. Fig. 24).

A frequency will be monitored for 3 seconds if ELT/PLB is not activated, and 10 seconds if ELT/PLB is activated.

If a signal is received during monitoring, the bearing value is indicated on the “Bearing” page for 30 seconds.

- In order to interrupt the current reception, press the “ESC” button. The system will continue with the next monitoring frequency.

Active reception will be interrupted after 30 seconds for a short moment in order to examine the other monitoring frequencies (safety function). This behavior can be changed under “Monitoring Settings” (s. 6.2.2.4, “Edit Scan” hotkey-description).

If the signal is lost during the monitoring procedure, the scanning process continues with the next frequency/channel after 30 seconds (depending on the settings of the bearing indication time and how many seconds (e.g. of 30 s - period) have already elapsed until the signal was interrupted).



Monitoring” On
Active frequency:
Main frequency = 131.510 MHz
Signal is received

“Monitoring” On
Active frequency:
Main frequency = 131.510 MHz
Signal has just interrupted

“Monitoring” On
Active frequency:
Monitoring frequency = 121.500 MHz
Signal is not present

Fig. 25 “Monitoring” mode. Example views of the “Bearing” page

- If at some point of scanning procedure the signal on the desired frequency is received, and monitoring of other frequencies is not desired anymore, press the “OK” button. The

frequency, that receives a valid signal at the moment of pressing the “OK” button, will be adopted as the main frequency, and the system will change to a normal bearing mode.

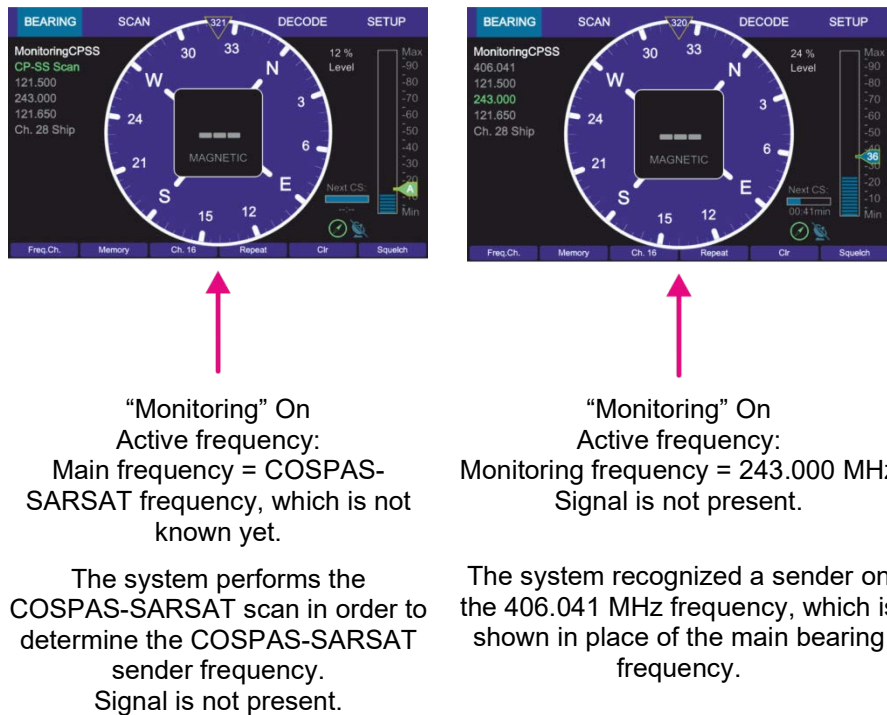

Fig. 26 “Monitoring CP-SS” mode. Example views of the “Bearing” page

In the case of COSPAS-SARSAT frequency as the main bearing frequency, the Monitoring CP-SS function is activated automatically, when the “Monitoring” scan is selected.

This operation mode differs from the normal monitoring mode with a non-CP-SS-frequency as the main bearing frequency (s. 6.2.2.2).

The “CP-SS” monitoring procedure will first look for the COSPAS-SARSAT signal and then, if no pulse has been detected for 60 seconds, it will search for other monitoring frequencies one after another (not alternating with the main frequency as it is in the standard case).

If a COSPAS-SARSAT signal is detected, the system releases an alarm and decode the pulse, which can then be seen on the “Decode” page.

Note

If a valid COSPAS-SARSAT signal is detected during the 60-seconds-period of the monitoring procedure, the correct COSPAS-SARSAT frequency channel of the sender is determined in the first cycle (first 60 seconds period of the CP-SS scan).

Only at the second cycle of this scan algorithm the bearing and decoding information of a COSPAS-SARSAT signal is stored and shown on the corresponding pages.

6.2.2.1 Timing of Normal Monitoring Operation

The main frequency (here channel 16, s. Fig. 27) is monitored with the highest priority. The duration of the monitoring cycles may be extended if signals are received on the monitoring frequencies.

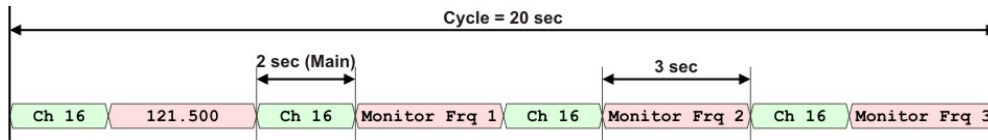

Fig. 27 Example: Timing normal monitoring

Note

Receiving on the monitoring frequencies can be triggered by the wrong adjustment of the squelch level!

Please always prove the correctness of the squelch adjustment on the scan frequencies.

6.2.2.2 Timing Monitoring with Selected Cospas-Sarsat Main Frequency

If the main frequency is adjusted to a Cospas-Sarsat frequency, the timing cycle will be changed automatically.

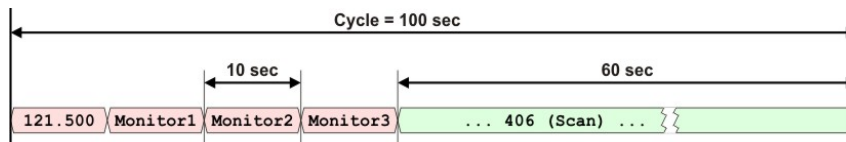

Fig. 28 Example: Timing Cospas-Sarsat monitoring

Additionally, the Cospas-Sarsat-scanning is activated, in order to catch the short pulse (duration of pulse approx. 400 msec, coming approx. every 50 seconds).

6.2.2.3 Monitoring with Filtering of Emergency Transmitters: ID-Only

Signals transmitted by emergency transmitters (PLB/ELT) are modulated with a typical sweeping tone. In order to exclude false alarms caused by disturbing signals or by not authorized radio-communication during monitoring mode, the function "emergency transmitter filtering ID-Only" can be activated.

Once activated, the alarm for all radio signals without the prescribed sweeping tone for emergency transmitters will be suppressed. Alert will be triggered only if a modulated emergency signal is recognized.

For the procedure of how to activate the emergency transmitter filtering function, see 6.2.2.4 (Fig. 31, position 6).

Note

For very weak signals the recognition of modulation may take a certain time.

Releasing an alarm can be delayed in this case.

6.2.2.4 Monitoring Settings

- To start the "Monitoring" mode select the corresponding line on the "Scan" page and press "OK" or the hotkey "Start Scan" (s. Fig. 29, position 1).

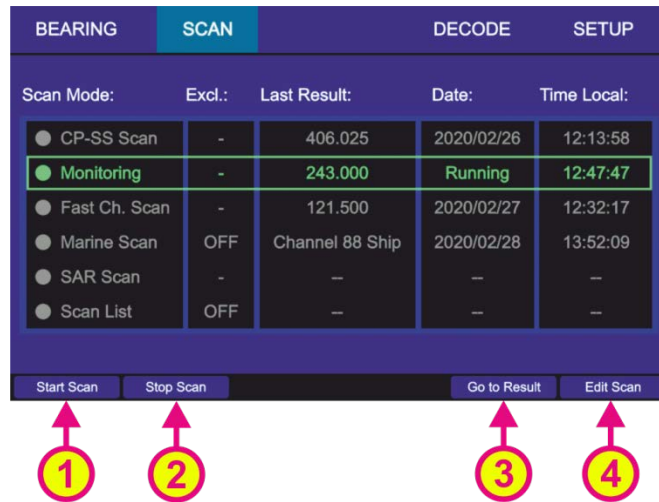

Fig. 29 "Monitoring" has been activated

- Pressing the hotkey "Stop Scan" (s. Fig. 29, position 2) will terminate the current scan mode and change to the bearing of the frequency that was set before the scan mode has been activated.
- You can also stop the scan mode by pressing the "HOME" button on the "Bearing" page with activated scan. After you have confirmed the special dialog (s. Fig. 30), this mode will be terminated.

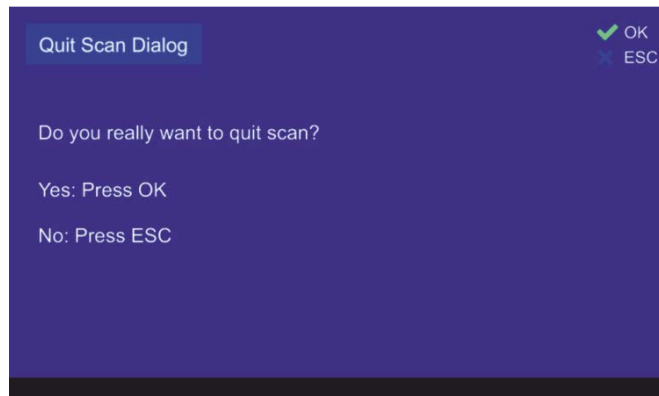

Fig. 30 Confirming of leaving the scan mode

- Pressing the hotkey "Go to Result" (s. Fig. 29, position 3) during the monitoring is currently running, will terminate the scan mode, adopt the frequency which was found in this scan last time and change to the "Bearing" page.
- Pressing the hotkey "Go to Result" if the scan mode is not activated, will lead to the "Bearing" page adopting the last result as the bearing frequency. This hotkey appears only if there is a result for this scan.
- Pressing the hotkey "Edit Scan" (s. Fig. 29, position 4) opens the dialog for changing the monitoring settings (s. Fig. 31).

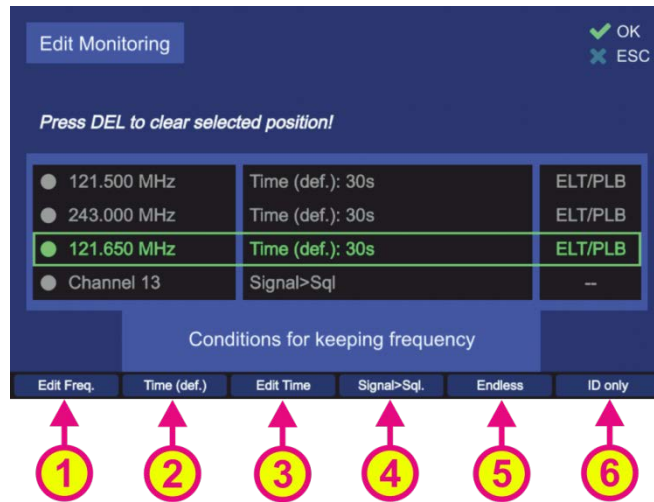

Fig. 31 Monitoring mode settings

- The hotkey “Edit Freq.” (s. Fig. 31, position 1) opens the dialog which allows the modification of the currently marked frequency. Type the new value in the input field “New Frequency” using the keyboard of the DCU. Or use one of the hotkeys (s. Fig. 32, position 1 or 2) to switch to the “Channel” or “Cospas-Sarsat” input mask.

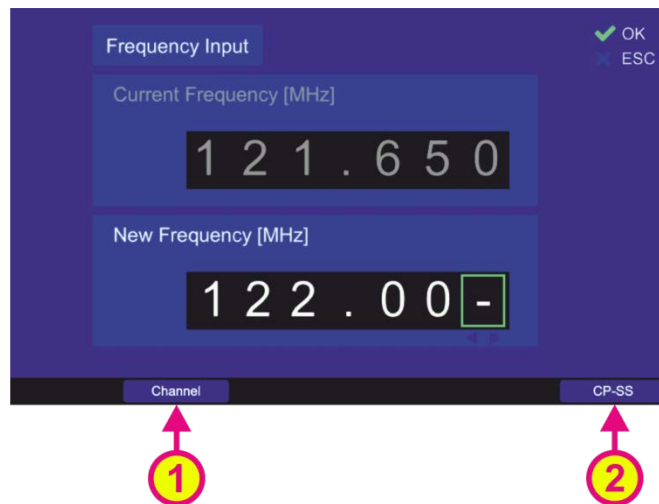

Fig. 32 Editing the current frequency

- Pressing the hotkey „Time (def)” (s. Fig. 31, position 2) will set the hold time (duration of staying in the scanning on this particular frequency) to the default value of 30 seconds.
- Pressing the hotkey “Edit Time” (s. Fig. 31, position 3) will open the sub-dialog for changing the hold time to the customized value (s. Fig. 33). Use the number keys of the DCU keypad to type the new value in and confirm it with “OK”.

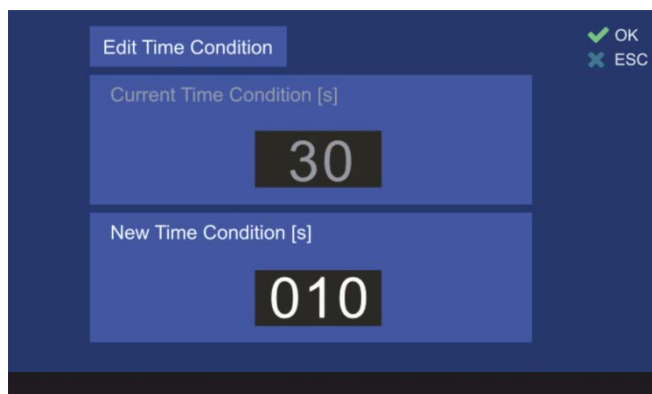

Fig. 33 Hold time setting

- The hotkey “Signal > Sql” defines the behavior of the monitoring algorithm to “signal level > squelch level” (s. Fig. 31, position 4).
If this hotkey has been pressed, the scan algorithm will stay on the active frequency until the signal level value becomes higher than the squelch value.
- The hotkey “Endless” (s. Fig. 31, position 5) defines the behavior of the monitoring algorithm when an active frequency has been found.
If this hotkey is pressed, the monitoring algorithm will stay on an active frequency as long as the user terminates the monitoring mode or skips the actual frequency.
- Pressing the hotkey “ID only” (s. Fig. 31, position 6) activates or deactivates the feature “ID Only” (s. 6.2.2.3):
 1. “**ELT/PLB**”:
The alarm is only triggered if an ELT/PLB signature is set, and the corresponding modulation has been detected. Otherwise, the alarm will not be activated.
 2. “**-**”:
Alarm is never triggered, regardless of whether the signal is modulated or not.

The hotkey “ID only” is only visible for the following frequencies:

- 121.500 MHz
- 243.000 MHz
- 121.650 MHz

6.2.3 Fast Channel Scan

The DF-system RT-800 can receive only one frequency at a given time. For simultaneous surveillance of several frequencies/channels, this scan mode can be used.

6.2.3.1 Fast Channel Scan Operation

In this scan mode, it is possible to scan up to eight freely selectable frequencies/channels across all the specified bands (available frequency bands are visible in the “Frequency Information” dialog, s. 6.4.1.8).

The selection of the 8 frequencies/channels which have to be scanned in the “Fast Channel Scan” mode, can also be done via “Memory” dialog, which can be opened by a hotkey on the “Bearing” page.

Note

If the fast channel scan is running, the hotkey “memory” does not react on pressing. Memory dialog is available after the fast channel scan mode is terminated.

Note

The “List of stored frequencies” of the “Memory” dialog (s. 6.1.2.6) internally linked to the list of frequencies of “Fast Channel Scan” (s. 6.2.3.3, Fig. 37). This only applies to frequencies that are marked for scanning (s. Fig. 15, “Scan”) in the “Memory” dialog. That means that activating/deactivating or deleting of a frequency in the “Fast Channel Scan” list causes the activating or deactivating (for scanning) of the same frequency in the “List of stored frequencies” of the “Memory” dialog.

The duration of the scan cycle for the maximal number of selectable frequencies is approximately two seconds, whereat all channels are scanned continuously one after another. If less than eight frequencies are selected, the duration of the scanning cycle decreases equivalently to their number (e.g. if four frequencies/channels are selected, one cycle of the scan procedure takes approximately one second).

In fast channel scan mode, the auto squelch is set automatically. The behavior of the auto squelch can be slightly influenced by adjusting the SNR value (Signal to Noise Ratio, s. 6.4.3.13). The SNR value indicates the number of level points above the noise level to which the auto squelch is set. For example, if the noise level on a specific channel is at 27% and the SNR value is adjusted to “7”, then the auto squelch level is set to 34%.

Since the selected frequencies in this mode can have different noise levels and originate from different bands, the SNR value for each frequency/channel can be adjusted separately.

After detection of a signal, the bearing is shown for 5 to 7 seconds for frequencies with the activated beep tone detection, additionally, the alarm is released. For frequencies with deactivated beep tone detection, the active bearing indication time is 30 seconds.

After the elapsing of this time, the scan algorithm interrupts the bearing indication and continues with scanning of other selected frequencies.

If the signal was lost, one second after the scanning process starts again at the next frequency/channel.

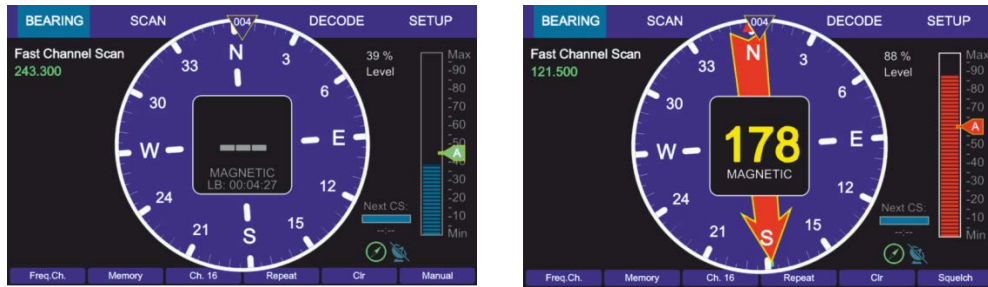

“Fast channel scan” = On
Active frequency = 243.300 MHz

Signal is not present.

“Fast channel scan” = On
Active frequency = 121.500 MHz

Signal is present.

Fig. 34 Fast channel scan indication on the "Bearing" page

In case that an unwanted signal is found, the scanning process can be proceeded immediately by pressing the “ESC” button.

If a signal is found and should be beared permanently, the scanning process can be ceased either by pressing the button “OK” (the current frequency will become the new bearing frequency on the “Bearing” page), or by pressing “HOME” (in the scan dialog “Stop Scan”) and then using the “Go to result” hotkey (s. 6.2.3.3).

Note

If there are interferences on the frequency band which are above the squelch level, scanning stops as well at these interferences (they are interpreted as signals). This may be avoided by adjusting the squelch level manually adjusting the SNR value.

Because of this, it may be possible that weak signals are not received anymore (for correct squelch adjustment see also chapter 6.5.3).

6.2.3.2 „Alarm Only Decoding“ / „Beep Tone“

If the mode “fast channel scan” is activated, a “Beep Tone” filter can be activated for each frequency additionally.

The alarm is only activated for signals with a distinct (preconfigured) audio frequency and activates an alarm immediately if such a signal was recognized.

The parameters of the audio signal (upper and lower audio frequency and the minimum required duration of the signal) can be configured on the “Setup” page (s. 6.4.3.6).

Note

This function can be used to search e.g. NOVATECH radio beacons which transmit a two-second signal with an 800Hz audio tone every six seconds.

6.2.3.3 Fast Channel Scan Settings

- To start the “Fast Channel Scan” mode select the corresponding line on the “Scan” page and press “OK” or the hotkey “Start Scan” (s. Fig. 35, position 1).

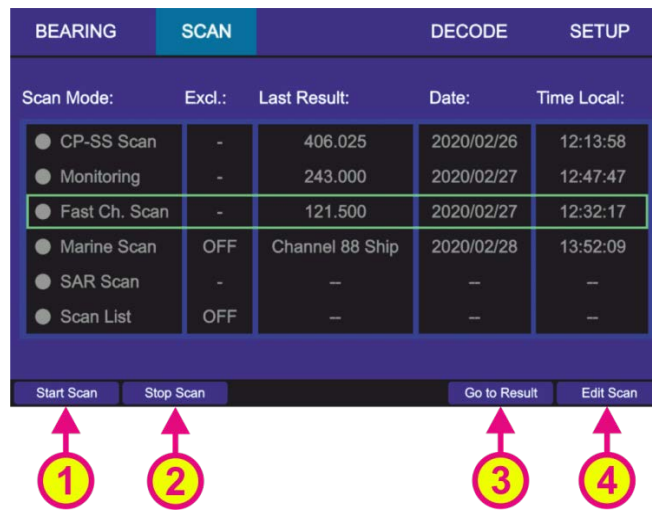

Fig. 35 Activating the “Fast Channel Scan”

- Pressing the hotkey “Stop Scan” (s. Fig. 35, position 2) will terminate the scan mode and change to the bearing of the frequency, that was set before the scan mode has been activated.
- You can also stop the scan mode by pressing the “HOME” button on the “Bearing” page with activated scan. After you have confirmed the special dialog (s. Fig. 36), this mode will be terminated.

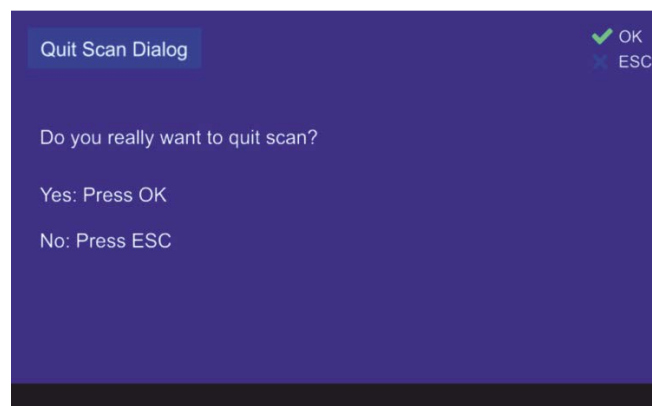

Fig. 36 Confirming of leaving the scan mode

- Pressing the button “OK” during the time of the active reception of the signal, the scanning mode will be deactivated, and the current frequency will become the new main frequency.
- Pressing the hotkey “Go to Result” (s. Fig. 35, position 3) during the fast channel scan is currently running, will terminate the scan mode, adopt the frequency which was found in this scan last time and change to the “Bearing” page into normal bearing mode.
Pressing the hotkey “Go to Result” if the scan mode is not activated, will lead to the “Bearing” page with the last result as the activated frequency.

This hotkey appears only if there is a result for this scan.

- Pressing the hotkey “Edit Scan” (s. Fig. 35, position 4) will open the dialog for changing the settings of the fast channel scan (s. Fig. 37).

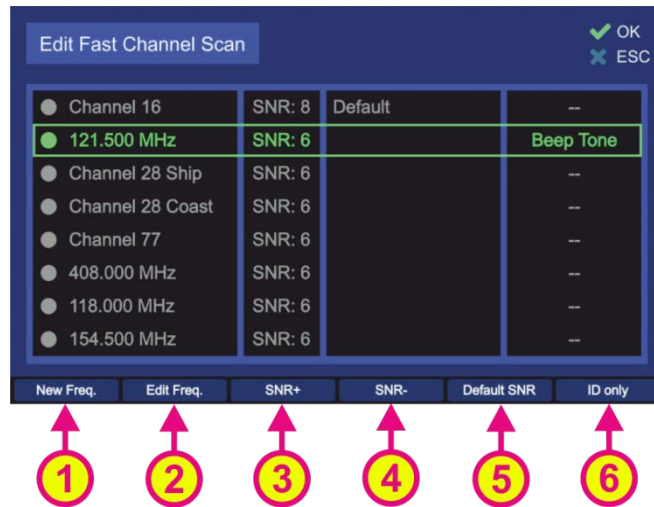

Fig. 37 Fast channel scan settings

- The hotkey “New Freq.” opens the dialog for adding the new frequency in the list (maximum 8 frequencies/channels). Use the keyboard of the DCU to input the new frequency into the corresponding input field or use one of the hotkeys (s. Fig. 38, positions 1 and 2) to open the “Channel” or “Cospas-Sarsat” input mask.

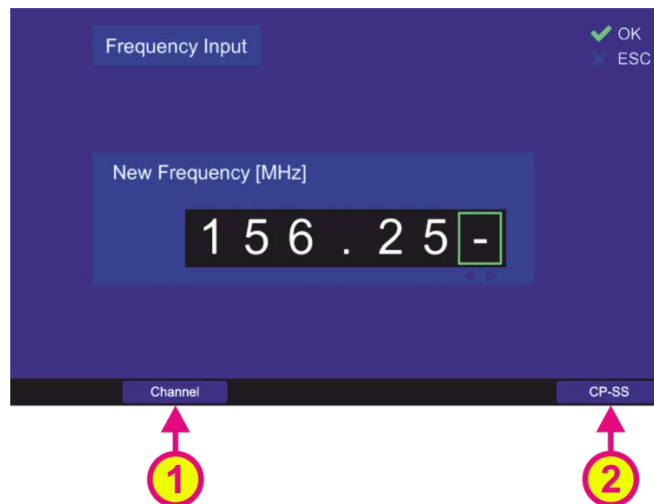

Fig. 38 Input of a new frequency to be scanned

- The hotkey “Edit Freq.” (s. Fig. 37, position 2) opens the input dialog that allows the modification of the currently marked frequency (s. Fig. 32 and its description in 6.2.2.4, the appearance of the dialog is different from the input of a new frequency that is presented in the Fig. 38).
- Pressing the hotkey „SNR+” (s. Fig. 37, position 3) will increase the SNR value of the currently marked frequency by 1%.

- Pressing the hotkey „SNR-“ (s. Fig. 37, position 4) will decrease the SNR value of the currently marked frequency by 1%.
- Pressing the hotkey “Default SNR” (s. Fig. 37, position 5) will set the SNR value of the currently marked frequency to the default value, which can be defined on the “Setup” page (s. 6.4.3.13).
- Pressing the hotkey “ID only” (s. Fig. 37, position 6) activates or deactivates the feature “ID Only” with two possible settings:
 - **“Beep Tone”:**
Alarm is only triggered if an audio tone in the valid range (configured via Setup, s. 6.4.3.6) has been detected. Else the bearing is suppressed.
 - **“--“:** Alarm is never triggered no matter if there is any modulation on it or not.

Note

“Beep Tone” is only active in “Fast Channel Scan”.

6.2.4 Marine Scan

The “Marine Scan” mode provides a quick scanning of the lower marine band.

The frequency range of the “Marine Scan” is defined from 156.050 MHz (Channel 01) to 157.425 MHz (Channel 88) and is scanned with 5 kHz frequency steps without gaps. The frequency range cannot be changed. The duration of one scanning cycle is approx. 3 seconds.

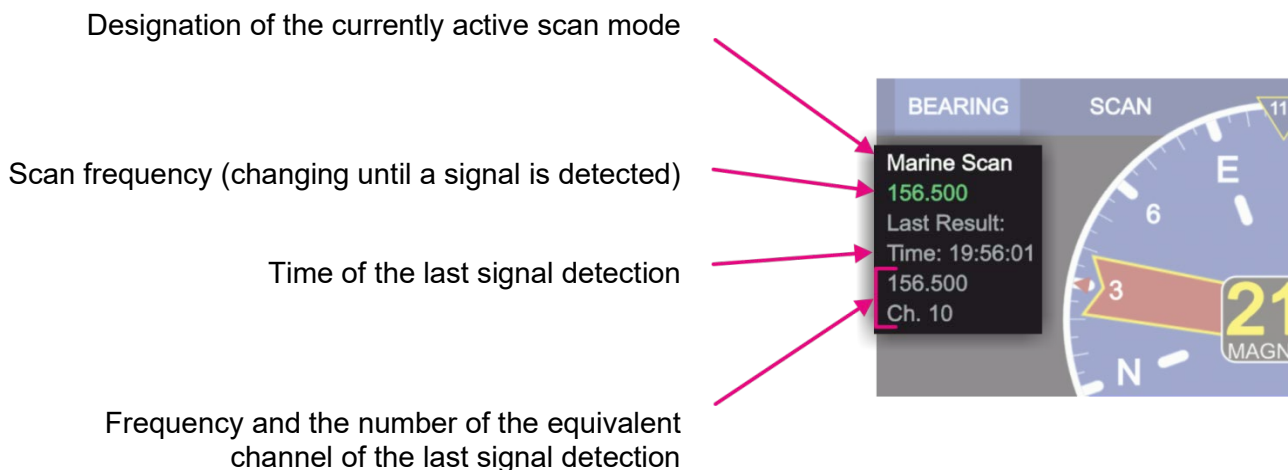

Fig. 39 Marine scan. Indication of frequencies

6.2.4.1 Marine Scan Operation

If a signal is found during the scan (signal level above squelch level), the scanning is interrupted and the bearing of the signal is held for 30 seconds (default value, which can be changed in the scan settings, s. 6.2.4.2), then the algorithm continues with scanning of next frequencies.

If the button “OK” is pressed during the time of the active reception of the signal, the scanning mode will be deactivated, and the current frequency will become the new main frequency.

If the signal was lost during the scan mode, the scanning process continues with the next frequency / channel after up to 30 seconds (depending on the setting of the bearing indication time, and how many seconds of the indication-time has already elapsed until the signal was interrupted).

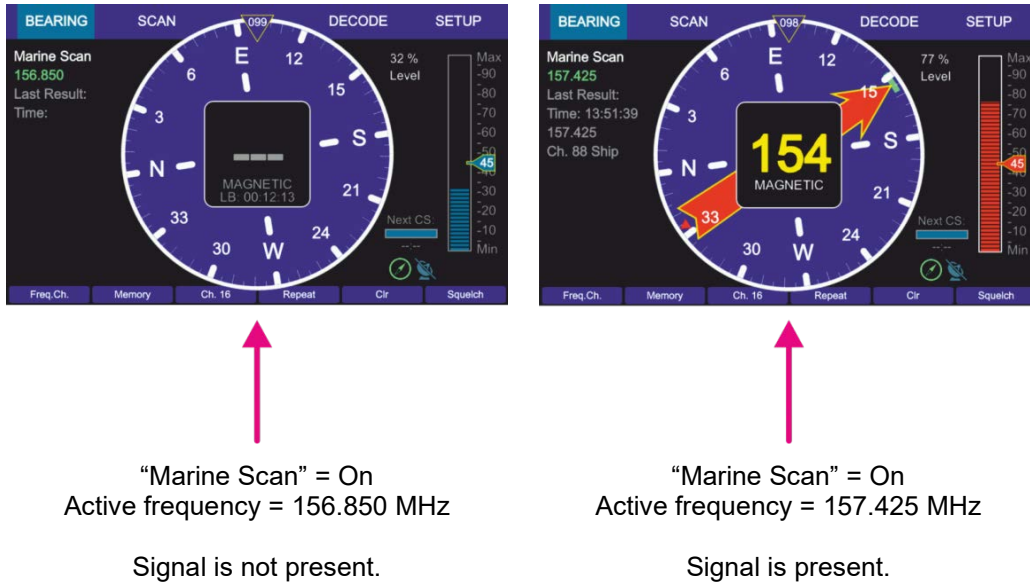

Fig. 40 Marine scan indication on the "Bearing" page

In case that an unwanted signal is found, the scanning process can be proceeded immediately by pressing the “ESC” button.

Note

If there are interferences on the frequency band which are above the squelch level, scanning stops as well at these interferences (they are interpreted as signals). This may be avoided by adjusting the squelch level manually using the “Up” and „Down“ arrow buttons. Because of this, it might be possible that weak signals are not received anymore (for correct squelch adjustment read also 6.5.3).

6.2.4.2 Marine Scan Settings

- To start the “Marine Scan” mode select the corresponding line on the “Scan” page and press “OK” or the hotkey “Start Scan” (s. Fig. 41, position 1).
- Pressing the hotkey “Stop Scan” (s. Fig. 41, position 2) will terminate the scan mode and change to the bearing of the frequency, that was set before the scan mode has been activated.
- The scanning process can be ceased also by pressing the button “HOME”. Then the direction finder changes to the bearing of the frequency, which was set before the scan mode was started.



Fig. 41 Marine scan is activated

- The hotkey “Excl. On/Off” is only visible, if “Marine scan” or “Scan List” is marked (s. Fig. 41, position 3).
By pressing this hotkey, the currently marked scan mode will proceed the “Exclude List” during the scan.
If this setting was already set for the currently marked scan mode, pressing this button will deselect this option and the “Exclude List” will be ignored during the scan procedure.
- “Edit Exclude” is only visible, if “Marine scan” or “Scan List” is marked (s. Fig. 41, position 4). By pressing this hotkey, the dialog for editing the “Exclude List” will be opened (s. 6.2.4.3).
- Pressing the hotkey “Go to Result” (s. Fig. 41, position 5) during the marine scan is currently running, will terminate the scan mode, adopt the frequency which was found in this scan last time and change to the “Bearing” page into normal bearing mode. Pressing the hotkey “Go to Result”, if the scan mode is not activated, will lead to the “Bearing” page with the last result as the activated frequency. This hotkey appears only, if there is a result for this scan.
- Pressing the hotkey “Edit Scan” (s. Fig. 41, position 6) will open the dialog for changing the settings of the marine scan (s. Fig. 42).

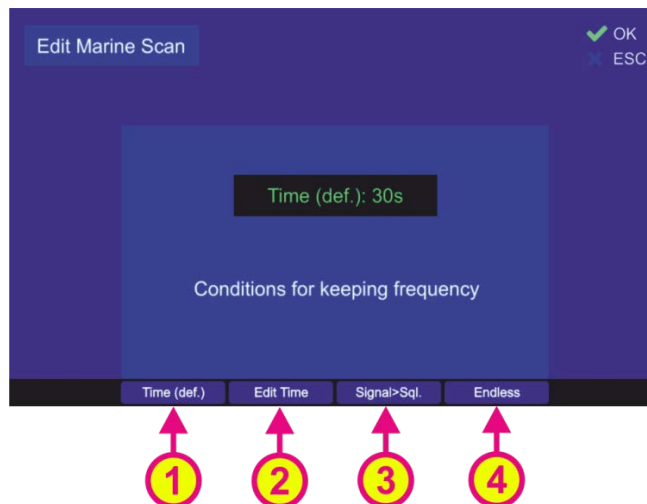

Fig. 42 Marine scan settings

- “Time (def.)” hotkey (s. Fig. 42, position 1) defines the behavior of the marine scan algorithm if the active frequency (signal level > squelch level) has been found. If this hotkey is pressed, the default time of 30 seconds will be adopted after confirming this setting with “OK”. Marine scan algorithm will stay for the default time of 30 sec on an active frequency before continuing with scanning of the lower marine band.
- Pressing the hotkey “Edit Time” (s. Fig. 42, position 2) will open a dialog for editing the time of staying on the actively received frequency before continuing with the scan procedure.
- Pressing the hotkey “Signal>Sql.” hotkey (s. Fig. 42, position 3) defines the time of staying on the actively received frequency before continuing with the scan procedure. If this setting is confirmed, the scanning procedure will stay on the actively received frequency as long as the signal level is higher than the squelch level.
- If the hotkey “Endless” (s. Fig. 42, position 4) was pressed and confirmed with “OK”, the marine scan algorithm will stay on the actively received frequency as long as the user terminates the scan or skips the current frequency.

6.2.4.3 Exclude List (for “Marine Scan” and “Scan List” modes)

The “Exclude List” (s. Fig. 41, position 4) is a dialog that allows defining single frequencies or frequency ranges that are to be excluded from the scanned frequency ranges for scan modes “Scan List” and “Marine Scan”.

Due to generating the scan algorithms in the AU (that always run through all the defined frequencies of the mode without the possibility of skipping), in case of signal reception of the “Exclude List”-frequency, this frequency will not be completely suppressed but there will be a short bearing indication. After less than one second, the indication interrupts and the marine scan procedure continues immediately with the next frequencies of the defined band.

- After pressing the hotkey “Edit Exclude” on the “Scan” page (see e.g., Fig. 41, position 4), the dialog for editing the “Exclude List” will be opened. In the case of first opening this dialog, all fields will be empty.



Fig. 43 „Exclude List“ configuration

- To insert a new frequency/channel or a range of frequencies/channels, press the hotkey „New Freq.“ (s. Fig. 43, position 1). The dialog for entering a new frequency will

be opened (s. Fig. 38 and its description in 6.2.3.3), where you can input any desired frequency.

In order to define a scope of frequencies “from ... to ...”, it is necessary to input any new frequency first. Then it is possible to proceed with editing the start- and stop-frequencies.

- Mark any line in the list and press the hotkey “Edit Start F.” (s. Fig. 43, position 3) to edit the start-frequency of the desired range to be excluded. The dialog for editing the frequency will be opened, where you can input any desired frequency (s. Fig. 32 and its description in 6.2.2.4).
- Mark any line in the list and press the hotkey “Edit Stop F.” (s. Fig. 43, position 4) to edit the stop-frequency of the desired range to be excluded. The dialog for editing the frequency will be opened, where you can input any desired frequency (s. Fig. 32 and its description in 6.2.2.4).

Note

Start- and stop-frequencies must be in the same frequency band (s. Table 1 in chapter 4), as the AU cannot switch from one band to another while running the fast scan algorithms.

- By pressing the hotkey “Delete Freq.” (s. Fig. 43, position 2), the marked line will be deleted immediately, regardless of whether it is a single frequency or a whole frequency range.
Leaving the dialog by pressing “OK”, the deleted frequency (or range) will not be excluded from the scanning procedure anymore.

6.2.5 SAR Scan

The main purpose of the “SAR scan” is finding COSPAS-SARSAT beacons, which usually transmit a signal on one of the 406-MHz-frequencies and additionally a continuous signal on other emergency frequency (mostly 121.500 MHz).

A COSPAS-SARSAT signal is a strong emergency signal (approx. 5 W), but its disadvantage is, that it is sent in the form of once-per-minute short pulses. They can be used to determine an activated emergency beacon over major distances. But since the direction of a pulsed signal, received from the great distance, might be influenced by reflections, noise, and distortions, it is still a rough ascertainment of the target.

The signals on other emergency frequencies are generally sent out with less power (approx. 100 mW) than the COSPAS-SARSAT pulses, but they are continuous, which allows better bearing performance compared to pulses. The bearing result becomes more precise the closer the direction finder antenna comes to the target.

The “SAR scan” procedure is organized in a way that facilitates the bearing of a COSPAS-SARSAT frequency and using breaks between the COSPAS-SARSAT pulses to observe other emergency frequencies. After a valid COSPAS-SARSAT signal was detected, it is possible either to change to the normal bearing mode on this frequency or stay in the scan mode in order to receive the continuous emergency signal on another emergency frequency after coming closer to the target.

The surveillance of up to five different frequencies (within the specified frequency bands) is possible:

- The main frequency is always a COSPAS-SARSAT frequency.
It is not possible to set other frequencies as the main frequency.

For the case that the exact COSPAS-SARSAT frequency of the emergency beacon is not known, there is a possibility to set “All CP-SS” in place of the main frequency, which will then trigger the COSPAS-SARSAT scan as the first step of this scan algorithm. After the first COSPAS-SARSAT impulse is detected, the exact COSPAS-SARSAT frequency will be identified automatically and used for the further bearing in this scan mode.

- Two next frequencies of this algorithm are always set by default and are not changeable:
 - 1) 121.500 MHz
 - 2) 243.000 MHz
- The two remaining scan frequencies are freely selectable.

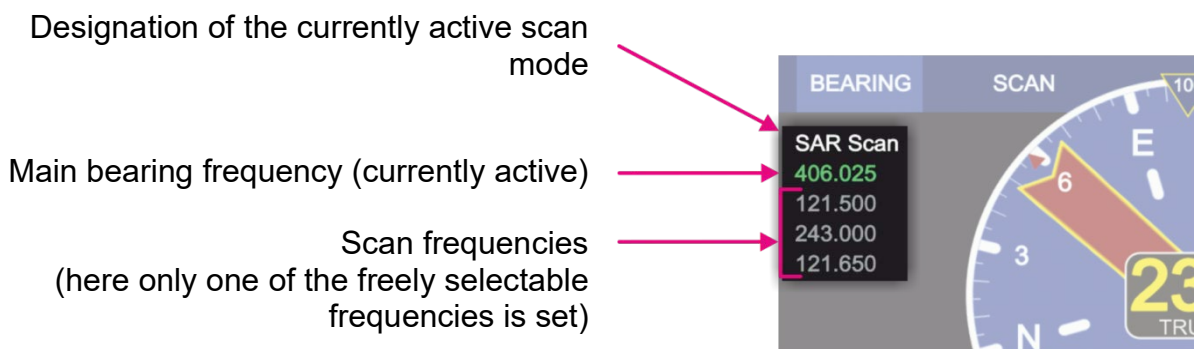

Fig. 44 SAR scan. Indication of frequencies

If the SAR scan function is activated, the DF system switches alternating from searching of the COSPAS-SARSAT pulse (main bearing frequency) to scanning of the other emergency frequencies using the breaks between the pulses (s. 6.2.5.1).

The currently monitored frequency is displayed highlighted in green, so you can see which frequency is active at a given moment (s. Fig. 44).

If a signal is received during the scan procedure, the bearing value is indicated on the “Bearing” page.

- In order to interrupt the current reception, press the “ESC” button. The system will continue with the next scan frequency.



“SAR scan” On
Active frequency:
Main bearing frequency = “All CP-SS”
The system performs the COSPAS-SARSAT scan in order to determine the COSPAS-SARSAT sender frequency.
Signal is not present.

“SAR scan” On
Active frequency:
Scan frequency = 243.000 MHz
Signal is present.
The system recognized a sender on the 406.058 MHz frequency, which is shown in place of the main bearing frequency.

Fig. 45 “SAR scan” mode. Example views of the “Bearing” page

- If at some point of scanning procedure, the signal on the desired frequency is received, and monitoring of other frequencies is not desired anymore, press the “OK” button. The frequency, that receives a valid signal at the moment of pressing the “OK” button, will be adopted as the main frequency, and the system will change to a normal bearing mode.

6.2.5.1 Timing of the SAR Scan Operation

The SAR scan procedure has slightly different timing in the cases of the unknown COSPAS-SARSAT frequency and the already determined COSPAS-SARSAT frequency after the first reception of the valid pulse.

In the case that COSPAS-SARSAT frequency is not known and the setting “All CP-SS” is set instead of an exact frequency, the system performs the COSPAS-SARSAT scan (s. 6.2.1) first.

The duration of this step is always 60 seconds, if the pulse is not detected. After elapsing of 60 seconds the system proceeds with the next frequencies.

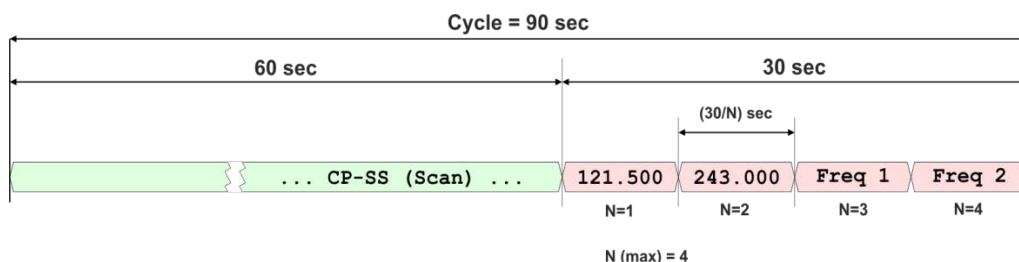

Fig. 46 Example: Timing SAR scan, if no frequency is detected

If during the 60 seconds-cycle a COSPAS-SARSAT pulse is detected, the scan procedure shows the bearing of the main frequency for approx. 3 seconds and then continues with the

scan frequencies. So if the pulse is detected at the beginning of the 60 seconds cycle, this cycle shortens down to 3 seconds.

If the COSPAS-SARSAT pulse is not detected, after elapsing of 60 seconds, the total time for scanning of the scan frequencies is 30 seconds, which enables the faster run-through of them.

The scanning time for each scan frequency depends on the number of the selected frequencies ($30 \text{ sec} / N$, N = number of frequencies).

This total time changes to 45 seconds after the first reception of the COSPAS-SARSAT pulse, which enables the efficient scanning of the selected frequencies without missing the next COSPAS-SARSAT pulses.

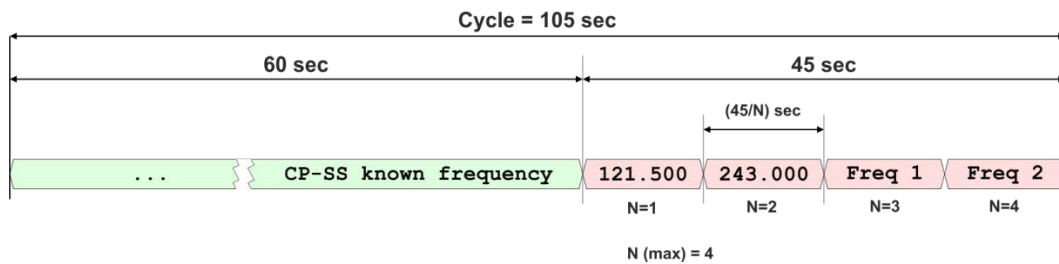

Fig. 47 Example: Timing SAR scan, if only COSPAS-SARSAT frequency is detected

If any of the selected emergency frequencies is detected, the scan algorithm will stay on this frequency (releasing the alarm, if this setting is activated under scan settings) until the 45-seconds-time elapses.

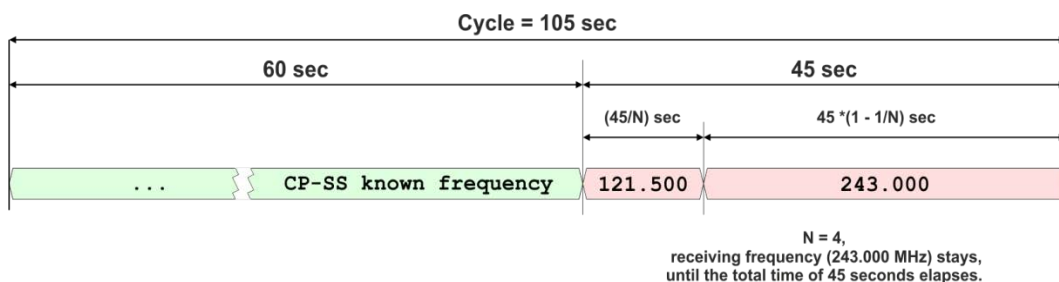

Fig. 48 Example: Timing SAR scan, if no CP-SS pulse but a signal on an emergency frequency is detected

The algorithm returns to the scanning of the main COSPAS-SARSAT frequency.

6.2.5.2 SAR Scan Settings

- To start the "SAR scan" mode select the corresponding line on the "Scan" page and press "OK" or the hotkey "Start Scan" (s. Fig. 49, position 1).

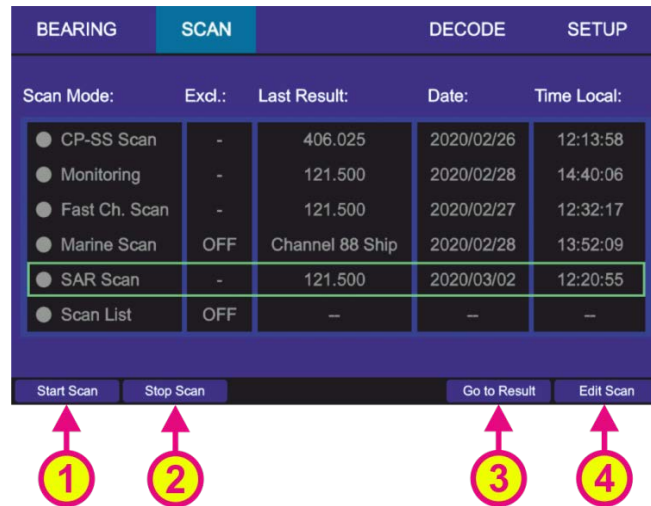

Fig. 49 Selecting SAR scan

- Pressing the hotkey “Stop Scan” (s. Fig. 49, position 2) will terminate the current scan mode and change to the bearing of the frequency, that was set before the scan mode has been activated.
- You can stop the scan mode by pressing the “HOME” while on the “Bearing” page with activated scan. After you confirm the dialog (s. Fig. 50), this mode will be terminated.

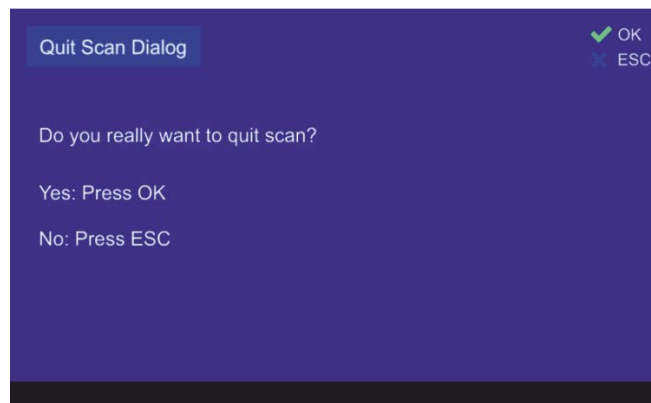

Fig. 50 Confirming of leaving the scan mode

- Pressing the hotkey “Go to Result” (s. Fig. 49, position 3) during the scan mode is currently running, will terminate the scan mode, adopt the frequency which was found in this scan last time and change to the “Bearing” page. Pressing the hotkey “Go to Result” if the scan mode is not activated, will lead to the “Bearing” page adopting the last result as the bearing frequency. This hotkey appears only, if there is a result for this scan.
- Pressing the hotkey “Edit Scan” (s. Fig. 49, position 4) opens the dialog for changing the SAR scan settings (s. Fig. 51).

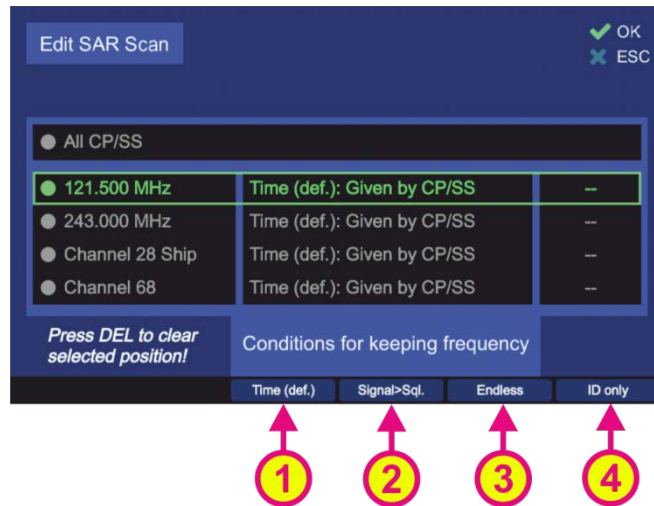

Fig. 51 SAR scan. Edit scan settings

- The hotkey “Edit Freq.” (s. Fig. 52, position A) is only visible if the COSPAS-SARSAT frequency (top frequency) or one of the free selectable frequencies is marked.

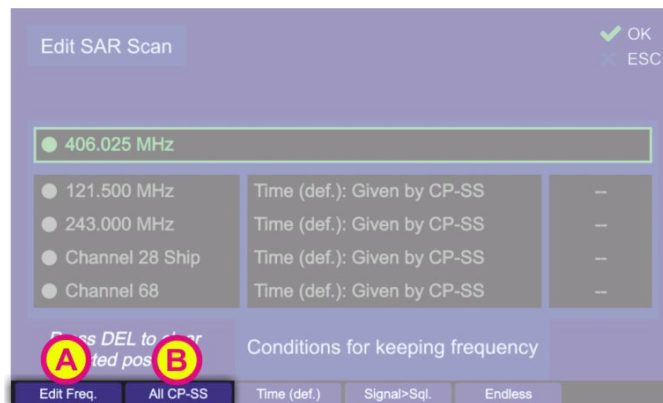

Fig. 52 Alternating hotkeys

The hotkey “Edit Freq.” opens the input dialog that allows the modification of the currently marked frequency (s. Fig. 32 and its description in 6.2.2.4). This hotkey only appears for the frequencies that are configurable (the last two displayed frequencies: Channel 28 Ship and Channel 68, s. Fig. 51).

- The hotkey “All CP-SS” is only visible if the COSPAS-SARSAT frequency is marked (s. Fig. 52, position B). By pressing this hotkey a COSPAS-SARSAT scan will be started in order to find an active COSPAS-SARSAT frequency during SAR scan algorithm.
- Pressing the hotkey „Time (def.)“ (s. Fig. 51, position 1) will set the hold time (duration of staying in the scanning on this particular frequency) to the value that is given by the CP-SS setting (30/N or 45/N), s. 6.2.5.1.
- The hotkey “Signal>Sql.” defines the behavior of the scan algorithm to “signal level > squelch level” (s. Fig. 51, position 2). If this hotkey is pressed, the scan algorithm will stay on the active frequency until the signal level value becomes higher than the squelch value.
- The hotkey “Endless” (s. Fig. 51, position 3) defines the behavior of the scan algorithm when an active frequency has been found.

If this hotkey is pressed, the scan algorithm will stay on an active frequency as long as the user terminates the scan mode or skips the actual frequency.

- Pressing the hotkey “ID only” (s. Fig. 51, position 4) activates or deactivates the feature “ID Only” (s. 6.2.2.3):

3. “**ELT/PLB**”:

The alarm is only triggered if an ELT/PLB signature is set and the corresponding modulation has been detected. Otherwise the alarm will not be activated.

4. “**-**”:

An alarm is never triggered, regardless of whether the signal is modulated or not.

The hotkey “ID only” is only visible for the following frequencies:

- 121.5 MHz
- 243 MHz

6.2.6 Scan List

The function “Scan List” provides a comfortable scanning feature of different frequency bands in one scan procedure.

The scan algorithm in the full scan list mode compares “Search List” (accessible over “Edit Scan”) and “Exclude List” (s. 6.2.4.3) and out of this comparison it generates an internal list of frequencies which is scanned. All results (received signals) are saved in a “Result List”.

Note

To make any changes in the “Scan List” or “Exclude List” please always stop the running scan procedure first.

Note

The “Start” and the “Stop” frequencies of one scan section to be entered (either in the search- or in the scan-list) have to be inside one frequency band (s. Table 1 in chapter 4).

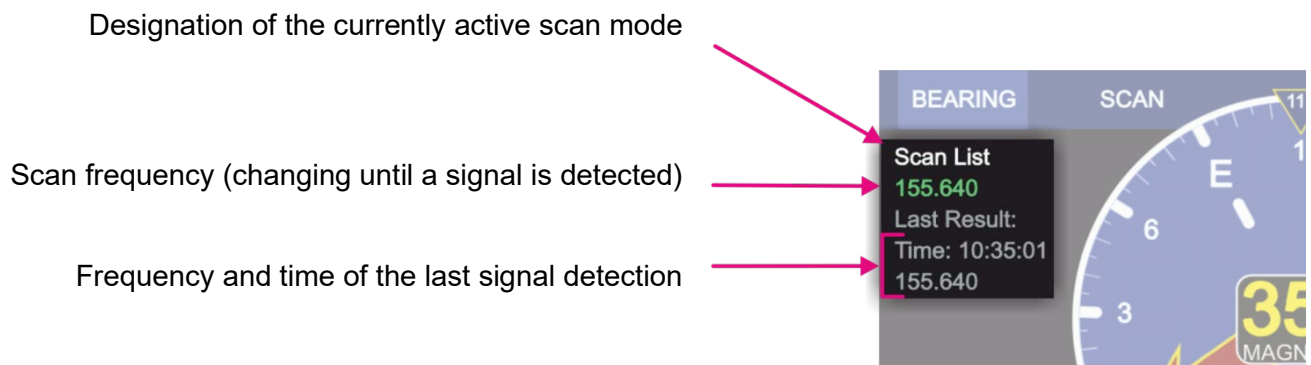

Fig. 53 Scan List. Indication of frequencies

Note

When restarting the “Scan List” mode, there is a possibility to scan the full-range-procedure that is given by comparison of search and exclude lists, or to scan only the result list.

The scan algorithm in the **“Result List” mode** starts the scan procedure, which runs only around the searched frequencies (last results). If the gap between the two frequencies is too large, the scan procedure will slightly slow down.

The actual scan operation works the same way as the scanning operation of “Marine Scan” (s. 6.2.4.1).

- To start the “Scan List” mode select the corresponding line on the “Scan” page and press “OK” or the hotkey “Start Scan” (s. Fig. 54, position 1).

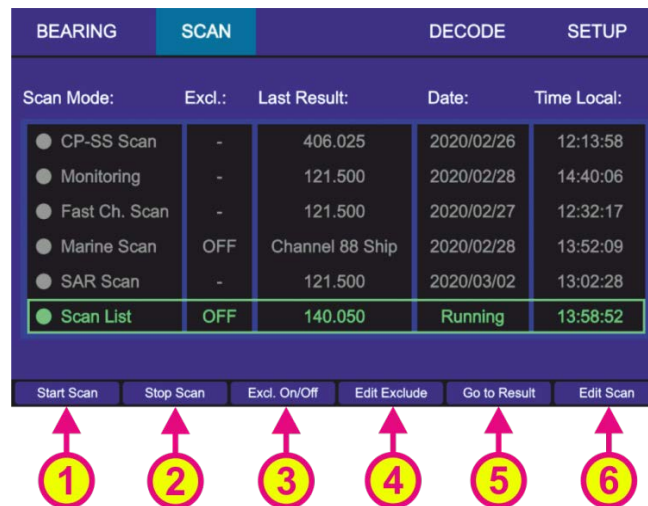

Fig. 54 "Scan List" is activated

- Pressing the hotkey “Stop Scan” (s. Fig. 54, position 2) will terminate the scan mode and change to the bearing of the frequency, that was set before the scan mode has been activated.
- The scanning process can be ceased also by pressing the button “HOME” while on “Bearing” page. Then the direction finder changes to the bearing of the frequency, which was set before the scan mode was started.
- The hotkey “Excl. On/Off” is only visible if “Marine scan” or “Scan List” is marked (s. Fig. 54, position 3).
By pressing this hotkey the currently marked scan mode will proceed the “Exclude List” during the scan.
If this setting was already activated for the currently marked scan mode, pressing this button will deselect this option and the “Exclude List” will be ignored during the scan procedure.
- “Edit Exclude” is only visible, if “Marine scan” or “Scan List” is marked (s. Fig. 54, position 4). By pressing this hotkey, the dialog for editing the “Exclude List” will be opened (s. 6.2.4.3).
- Pressing the hotkey “Go to Result” (s. Fig. 54, position 5) during the scan list mode is currently running, will interrupt the scan mode, and open the “Result List”, where you can select the next action (s. Fig. 55). This hotkey appears only if there is a result for this scan.

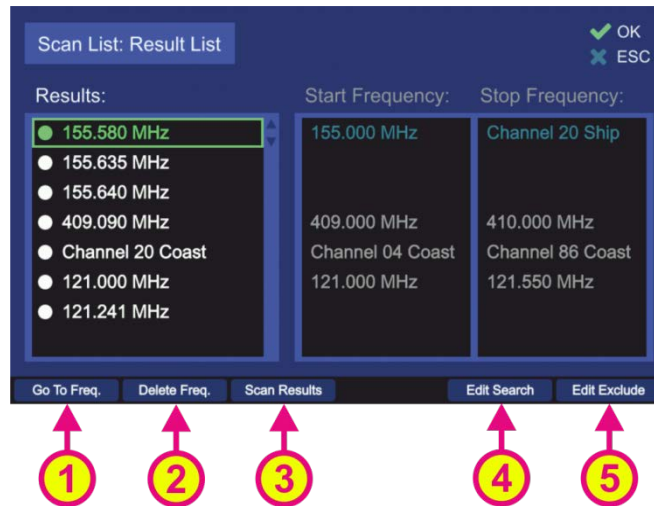

Fig. 55 Result List Settings

- Pressing the hotkey “Go to Freq.” (s. Fig. 55, position 1) adopts the currently marked frequency as main bearing frequency and switches to the normal bearing mode on the “Bearing” page.
 - Pressing the hotkey “Delete Freq.” (s. Fig. 55, position 2) deletes the currently marked frequency from “Result List”. The deleted frequency will not be skipped anymore, when the results are scanned after pressing “Scan Results”.
 - Pressing “Scan Results” (s. Fig. 55, position 3) starts the scan list mode, which runs only around the frequencies which had a result during the last scan (frequency span around 100 kHz).
 - Pressing “Edit Search” (s. Fig. 55, position 4) will open the “Search List” dialog (s. “Edit Scan” below).
 - Pressing “Edit Exclude” (s. Fig. 55, position 5) will open the “Exclude List” dialog (s. 6.2.4.3).
- Pressing the hotkey “Edit Scan” (s. Fig. 54, position 6) will open the dialog for changing the settings of the “Search List” (s. Fig. 56).



Fig. 56 "Search List" settings

- Pressing the hotkey “New Freq.” (s. Fig. 56, position 1) generates a new line in the “Search List” and opens the dialog for frequency/channel input (s. Fig. 32 and its description in 6.2.2.4). When entering a new start frequency, the stop frequency is automatically set to the same value as the start frequency.
- Pressing the hotkey “Delete Freq.” (s. Fig. 56, position 2) deletes the currently marked line from the “Search List”. After an entry has been deleted and the dialog left by pressing “OK”, the deleted frequency range will not be scanned anymore, when you restart the scan.
- Pressing the hotkey “Edit Start F.” (s. Fig. 56, position 3) opens the “Frequency Input Dialog” (s. 6.1.2.2), which allows modifying the “Start” frequency of the currently marked frequency range.
- Pressing the hotkey “Edit Stop F.” (s. Fig. 56, position 4) opens the “Frequency Input Dialog” (s. 6.1.2.2) which allows modifying the Stop Frequency of the currently marked frequency range.

Note

Start- and stop-frequencies must be in the same frequency band (s. Table 1 in chapter 4), as the AU cannot switch from one band to another while running the scan algorithms.

Note

When choosing a COSPAS-SARSAT frequency as “Start” frequency, the AU will perform a COSPAS-SARSAT scan and scan all CP-SS frequencies. A “Stop” frequency cannot be set for this option, as always all CP-SS frequencies are scanned.

Note

The squelch adjustment is only possible for a maximum of 8 frequency bands in the search list.

If there are more than 8 frequency bands in the search list, the squelch adjustment for the remaining bands, will be 30% (default value).

In order to avoid the bearing of the noise, it is recommended to stay in the number of eight bands. If a set-up of more bands is needed, you can set wider bands and split them into narrow bands using the “Exclude List”.

- Pressing the hotkey “Edit Cond.” (s. Fig. 56, position 5) opens the “Scan List Conditions” dialog.

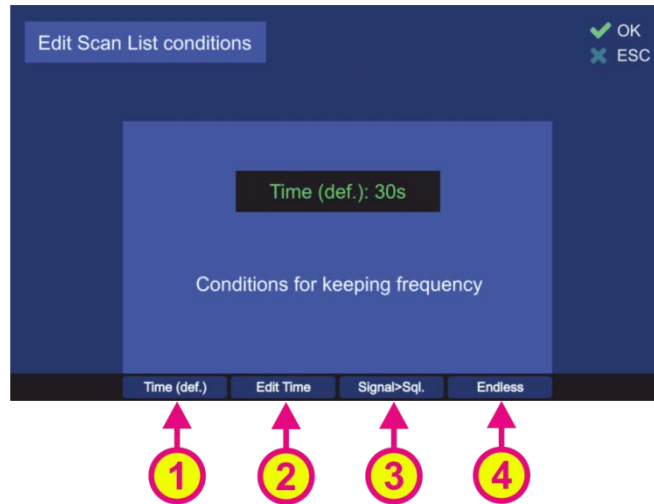

Fig. 57 "Scan List Conditions" dialog

- "Time (def.);" hotkey (s. Fig. 57, position 1) defines the behavior of the "Scan List" algorithm if the active frequency (signal level > squelch level) has been found. If this hotkey is pressed, the default time of 30 seconds will be adopted after confirming this setting with "OK". The scan algorithm will stay for the default time of 30 sec on an active frequency before continuing with scanning of the next frequencies.
- Pressing the hotkey "Edit Time" (s. Fig. 57, position 2) will open a dialog for editing the time of staying on the actively received frequency before continuing with the scan procedure.
- Pressing the hotkey "Signal>Sql." hotkey (s. Fig. 57, position 3) defines the time of staying on the actively received frequency before continuing with the scan procedure. If this setting is confirmed, the scanning procedure will stay on the actively received frequency as long as the signal level is higher than the squelch level.
- If the hotkey "Endless" (s. Fig. 57, position 4) was pressed and confirmed with "OK", the scan algorithm will stay on the actively received frequency as long as the user terminates the scan or skips the current frequency.

6.3 Decode Page

The “Decode” page manages the decoded COSPAS-SARSAT data. It does not only display the decoded COSPAS-SARSAT information but also stores the messages over time and calculates the true bearing and distance to the emergency beacon if the GPS data is available in the message. Furthermore, the calculated true bearing can be exported to the ”Bearing” page which is displayed as a “GPS-Arrow” in gray.

Press on “DECODE” in order to open the decode page.

When switching to “Decode” page, the active COSPAS-SARSAT frequency is determined by the following conditions:

- By switching from “Bearing” page, the COSPAS-SARSAT frequency, which was active in the “Bearing” page, will be adopted.
- If no COSPAS-SARSAT frequency was active on the “Bearing” page, the last active frequency on the “Decode” page will be used.
- If on the “Decode” page no frequency was set or used, the frequency group “406.022...028” is selected per default (s. 6.1.2.5).

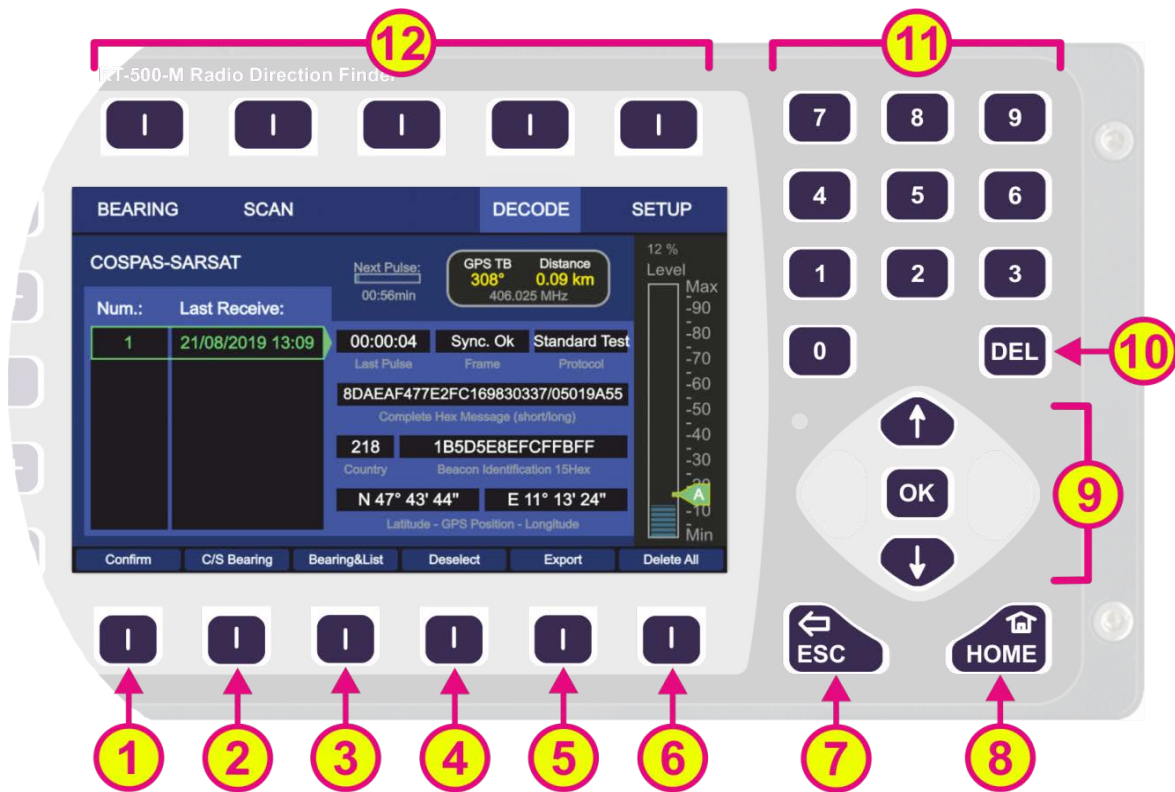

Fig. 58 Decode Page. General view

Indication on Decode Page

| Pos. | Element | Meaning / Description |
|------|-----------------------|---|
| 1 | „406.025“ / „Confirm“ | Pressing this hotkey will open the “Frequency Input Dialog” with the COSPAS-SARSAT frequency groups (6.1.2.5). The hotkey label corresponds to the current operating frequency. |





| | | |
|----|---|--|
| 2 | “C/S Bearing” | Pressing this hotkey will activate the view for “COSPAS-SARSAT Bearing”. |
| 3 | “Bearing&List” | Pressing this hotkey will activate the view for “Bearing&List”. |
| 4 | “Deselect” | Pressing this hotkey deselects the currently marked line. Deselected lines are indicated by gray text. |
| 5 | “Export” | Pressing this hotkey will export the selected messages to the “Bearing” page. On the “Bearing” page the GPS coordinates of these messages will be shown with “GPS arrows”. |
| 6 | “Delete All” | Pressing this hotkey will open a dialog for deleting all stored CP-SS messages. |
| 7 |  | If the dialog is opened, pressing this button will close the dialog without saving new values. If no dialog is opened, pressing this button will lead you back to the last activated page. The Bearing Page is the end point. |
| 8 |  | Pressing this button always leads to the “Bearing” page. Even an opened dialog will be closed. If a sub-dialog is opened, pressing this button will close it and lead to the “Bearing” page, without saving the changed values. |
| 9 |  | “Up” and “Down” arrows are used to select between the different lines from the list of received messages (move the green frame). Using “Left” and “Right” on the selected line, switches between decoded COSPAS-SARSAT messages with the same beacon ID but different time stamp. Pressing the “OK” button will select the currently marked line from the list of received messages. |
| 10 |  | Pressing the “DEL” button will open a dialog for deleting the currently shown COSPAS-SARSAT message of the currently marked line from the list of received messages. |
| 11 |  | Numeric keys are used to enter the numerical characters inside the dialogs. No function on the top level of the “Decode” page. |
| 12 | Top line | Navigation line of the screen, which allows switching between pages (BEARING, SCAN, DECODE, SETUP). |

Table 11 Decode page, list of elements

6.3.1 Selecting a COSPAS-SARSAT frequency

In order to receive a COSPAS-SARSAT data pulse and to decode its content, the main frequency has to be adjusted to a COSPAS-SARSAT frequency. This can be done on the “Bearing” page or directly on the “Decode” page using the hotkey „406.025“ (s. Fig. 58, position 1).

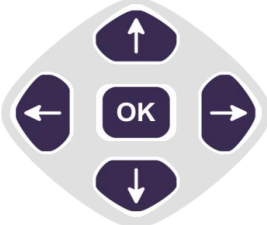
6.3.2 COSPAS-SARSAT List View

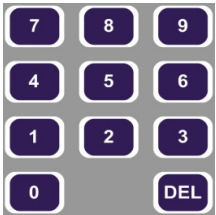
Press the hotkey “C/S List” (s. Fig. 61, position 2) in order to get to the COSPAS-SARSAT list view.

This view shows the list with the received COSPAS-SARSAT pulses.

When an emergency beacon is activated, it transmits a COSPAS-SARSAT pulse every 50 sec (± 5 sec). As soon as a valid pulse is received, the hotkey “406.025” changes its label to “Confirm” and blinks in yellow (s. Fig. 59). Additionally, an acoustic warning tone is emitted. Press “Confirm” in order to accept the message and to clear the alarm.

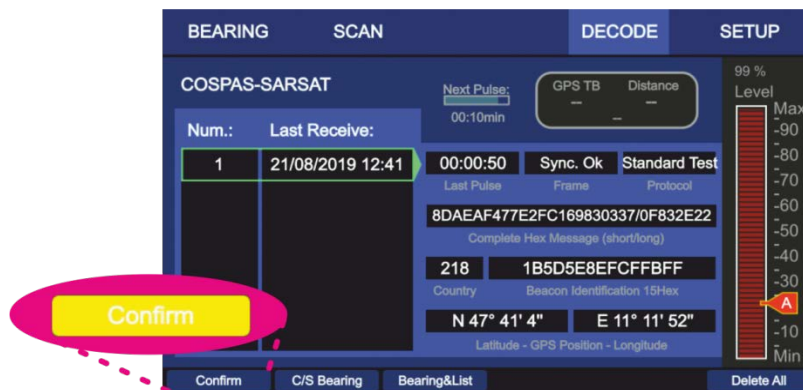

Fig. 59 Confirming a new COSPAS-SARSAT message

For each new received ID (different beacon) a new line is generated so that messages are sorted according to the beacon ID. Each line number (column “Num.:”) is related to a certain COSPAS-SARSAT beacon ID. The time entry in the line shows the receiving time of the message (s. Fig. 60, “A”). The corresponding COSPAS-SARSAT message content of the selected beacon ID is displayed in the area “B” on the right side of the screen.

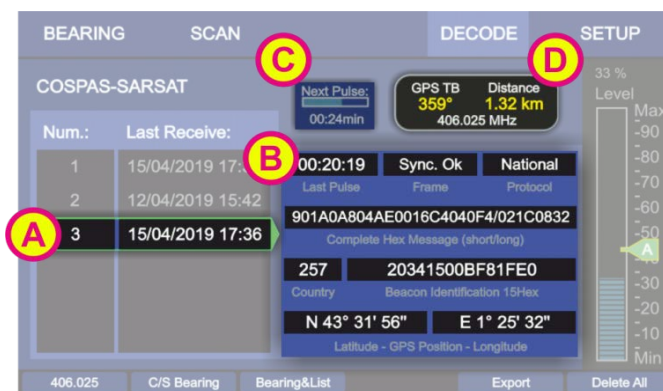

Fig. 60 Decode Page. COSPAS-SARSAT List View

Pressing the “Left” and “Right” arrow buttons of the keypad switches between the older and newer messages of the same emergency beacon.

Press “DEL” button of the keypad to delete a selected message.
Press hotkey “Delete All” in order to delete all COSPAS-SARSAT messages.
A detailed explanation of all hotkeys can be found in the next chapters.

Area “C” indicates the time when the next COSPAS-SARSAT pulse is expected. If after one minute no COSPAS-SARSAT pulse is received, the bar-graph-indicator is fully filled and shows the text “--:--”.

The indicator in the area “D” (s. Fig. 60, “D”) shows the following values:

- Direction from the current GPS position to the position of the marked COSPAS-SARSAT message (“GPS TB” = GPS True Bearing).
- Distance from the current GPS position to the position of the actually marked COSPAS-SARSAT message (the indication “km” or “NM” is adjustable in the “Setup”, s. 6.4.2.6).
- Frequency:
 - By viewing an old message frequency may be other than the current frequency. In this case the frequency is displayed in gray.
 - The current frequency is displayed in white. The current frequency is also displayed in the label of the hotkey for adjusting frequency.

Note

GPS TB data can be shown only if compass and GPS are available.
The distance can be shown without connection of vessels compass if GPS is connected to DCU.

6.3.3 COSPAS-SARSAT Bearing View

This COSPAS-SARSAT bearing view allows the graphical indication of the decoded COSPAS-SARSAT information of the selected beacon ID.
Press the hotkey “C/S Bearing” (s. Fig. 58, position 2) to open the “COSPAS-SARSAT Bearing” view.

Note

Please note that the label of the hotkey will turn to “C/S List” in order to get to the list page again (s. 6.3.2).

The “C/S Bearing” page displays the following information, which corresponds to the selected beacon ID:

- The numerical bearing indication (True Bearing)
- The indication of the calculated bearing as the gray arrow (“GPS Arrow”)
- The calculated distance to the target
- The COSPAS-SARSAT frequency
- The heading of the ship indicated by the compass rose and the top triangle (here: 61°)
- Corresponding number and beacon ID and
- the time of the last received pulse

Pressing the “Left” and “Right” arrow buttons of the keypad switches between the older and newer messages of the same emergency beacon.

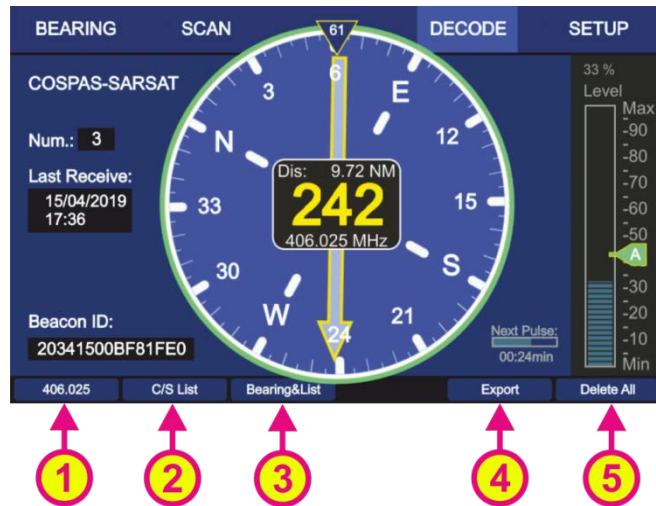

Fig. 61 Decode Page: Bearing View

- Change the active COSPAS-SARSAT frequency by using the hotkey “406.025” (s. Fig. 61, position 1).
- Pressing the hotkey “C/S List” (s. Fig. 61, position 2) will open to the “COSPAS-SARSAT List” view (s. 6.3.2).
- Pressing the hotkey “Bearing&List” (s. Fig. 61, position 3) will change to the “COSPAS-SARSAT Bearing and List” view (s. 6.3.4).
- Like in the “COSPAS-SARSAT List” view, it is possible to delete all stored COSPAS-SARSAT messages by pressing the hotkey “Delete All” (s. Fig. 61, position 5). This action must be confirmed.

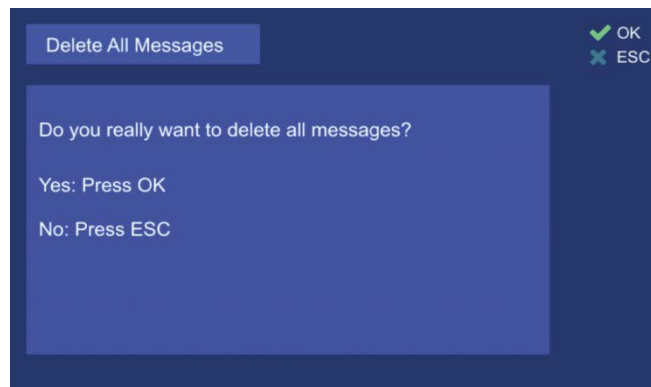

Fig. 62 Dialog for confirming of deleting all CP-SS messages

- Hotkey “Export” exports the GPS coordinates of the currently displayed COSPAS-SARSAT message to the “Bearing” page. (s. Fig. 61, position 4). See also chapter 6.3.5 “Export to Bearing Page”.

6.3.4 COSPAS-SARSAT Bearing and List

This view combines the “COSPAS-SARSAT Bearing” and “COSPAS-SARSAT List” views for the last arrived COSPAS-SARSAT messages (s. Fig. 63).



Fig. 63 "Decode" page. "Bearing and List" view

- Use the hotkey “406.025” for changing the frequency (s. Fig. 63, position 1).
- Pressing the hotkey “C/S Bearing” (s. Fig. 63, position 2) will change to the “COSPAS-SARSAT Bearing” view (s. 6.3.3).
- Pressing the hotkey “C/S List” (s. Fig. 63, position 3) will change to the “COSPAS-SARSAT List” view (s. 6.3.2).
- Hotkey “Export” exports the GPS coordinates of the currently displayed COSPAS-SARSAT message to the “Bearing” page (s. Fig. 63, position 4). See also chapter 6.3.5 “Export to Bearing Page”.
- Like in the “COSPAS-SARSAT List” view, it is possible to delete all stored COSPAS-SARSAT messages by pressing the hotkey “Delete All” (s. Fig. 63, position 5).

6.3.5 Export to Bearing Page

The calculated bearing of an emergency beacon, which is based on the decoded GPS position, can be exported to the “Bearing” page by pressing the hotkey “Export” (s. Fig. 61 or Fig. 63, position 4). In this case, the RT-800 is operating on the selected COSPAS-SARSAT frequency in the normal bearing mode.

The GPS based information like:

- numerical indication of the GPS true bearing,
- indication of the GPS true bearing as the “GPS Arrow” in gray,
- the calculated distance to the emergency beacon

is displayed at the same time.



Fig. 64 Indication of the GPS based bearing on the Bearing page

In order to remove the indication of the “GPS Arrow” from the “Bearing” page, keep the “Clr” hotkey pressed for a few seconds until the arrow disappears (the indication of GPS true bearing as well as the calculated distance will disappear together with the arrow).

6.4 Setup Page

After the AU and power supply were connected to the DCU and the system was switched on, it is ready to work with the default settings.

All system settings, configurations etc. are made in the "Setup" page.

The screen top line of the "Setup" page contains navigation keys that include system setup menus sorted by the common concept. The settings of these menus will be explained further in this chapter.

The bearing runs in the background while changing settings on the "Setup" page. That means e. g. when bearing on 121.5 MHz and switching from "Bearing" page to the "Setup" page, an ELT signal will be detected and the alarm will be provided.

Note

Incorrect settings may lead to considerable malfunctions of the DF system RT-800. Therefore, sensitive parameters concerning the bearing operation are password-protected against not authorized alterations. Any changes of settings, which require password approval, are to be made only by instructed personnel.

6.4.1 General

After selecting the "Setup" over the corresponding hotkey (Fig. 2, pos. 16) on the "Bearing" page, the following menu page opens (s. Fig. 65).

The menu "General" contains uncritical settings which can be changed any time without influence on the important system parameters, therefore it is not password protected and can be used by the operator.

Furthermore, the menu provides general information like serial numbers and software versions of DCU and AU.

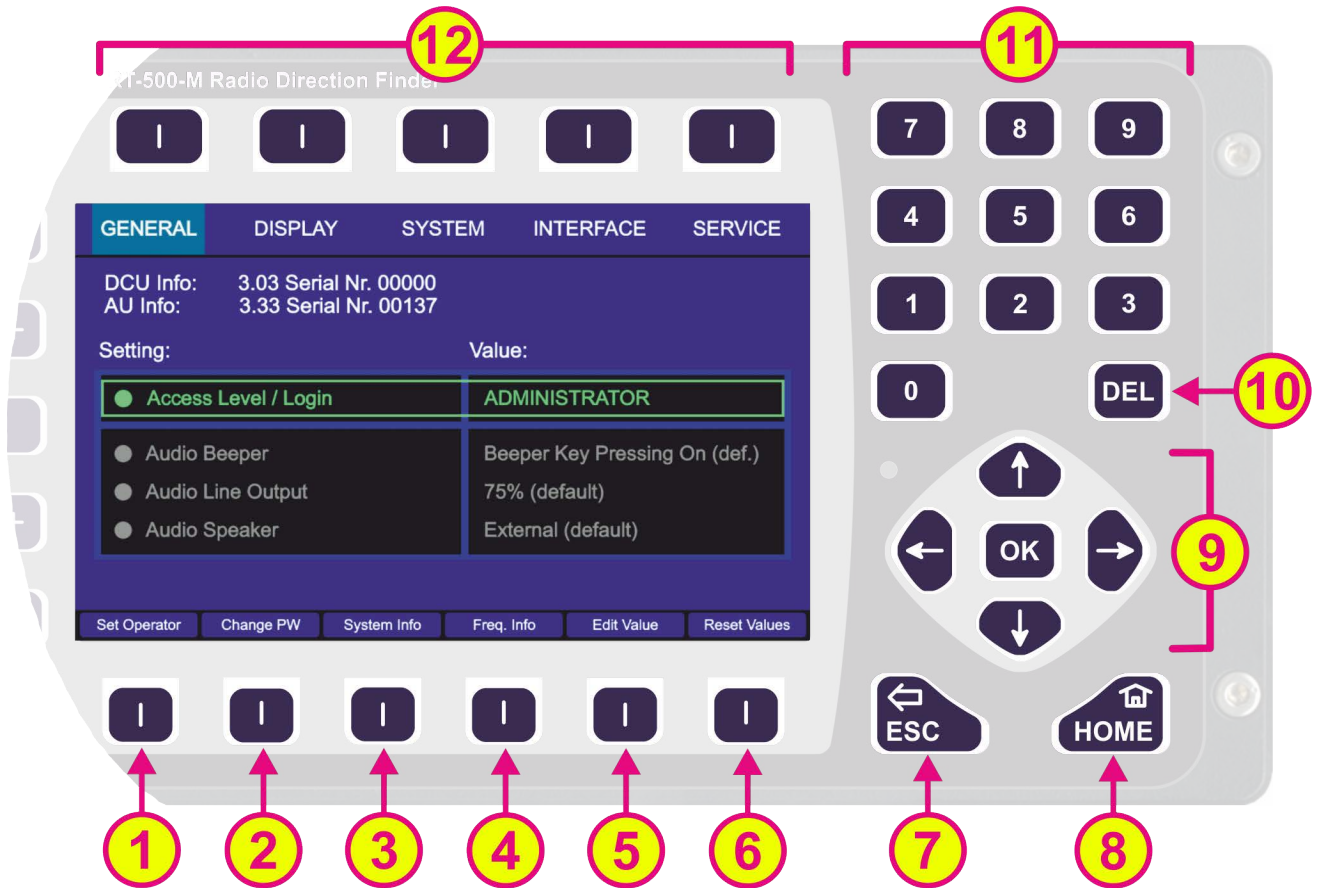

Fig. 65 Setup page. General settings (administrator view)

Indication on Setup Page, General Settings

| Pos. | Element | Meaning / Description |
|------|------------------------------|--|
| ① | „Set Operator” / „Set Admin” | Switches between two states: - Access level: operator - Access level: administrator |
| ② | “Change PW” | Pressing this hotkey will lead to the dialog for changing the password for the “Administrator” access level, where a password has to be entered (old password has to be entered first, whereupon the new password can be defined). |
| ③ | “System Info” | Opens a dialog which shows the information about the revisions status of the used system components (s. 6.4.1.9). |
| ④ | “Freq. Info” | Opens a dialog which shows the currently available frequencies (also not available or locked frequencies are shown) (s. 6.4.1.8). |
| ⑤ | “Edit Value” | Depending on the currently marked line, using this hotkey will open the dialog for changing the corresponding value (s. descriptions below). |
| ⑥ | “Reset Values” | Resets all values to the default settings (s. 13.4). The default values themselves cannot be changed by the user (RHOTHETA specification). |





| | | |
|----|--|--|
| 7 |  | When there is a dialog opened, pressing this button will close the dialog without adopting new values. When there is no dialog opened, pressing this button will go back to the last activated page. The Bearing Page is the end-point. |
| 8 |  | Pressing this button always leads to the Bearing Page. Even an opened dialog will be closed, without adopting the changed values. |
| 9 |  | “Up” and “Down” arrows are used to select between the general settings (move the green frame). Inside the dialogs (e.g. password or value editing) they are used to navigate between the characters of the virtual keypad. “Right and “left” arrows have a function inside the dialogs, but not on the top level of the “Setup” page. With the “OK” button the confirming of values or opening the general settings dialogs is accomplished. |
| 10 |  | Inside the general settings dialogs the “DEL” button is used to clear the whole input at once. On the top level of the “Setup” page, this button has no function. |
| 11 |  | Numeric keys are used to enter the numerical characters inside the dialogs. On the top level of the “Setup” page they have no function. |
| 12 | Top line | Navigation line of the screen, which allows switching between setup menus (“General”, “Display”, “System”, “Interface” and “Service”). |

Table 12 Setup page, general settings. List of elements

6.4.1.1 Access Level / Login

Depending on the access level of the user, the scope of accessible and visible settings on the “Setup” page is different.

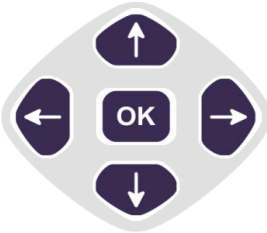
Operator:

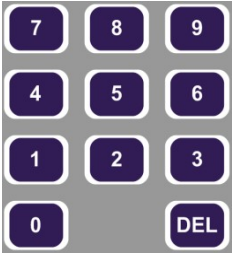
The “Setup” page will only allow making settings in the menu “General”. This ensures that no essential system settings can be influenced or corrupted by mistake.

The access level “Operator” does not require any password as the operator has the minimum set of options for possible setup of the system.

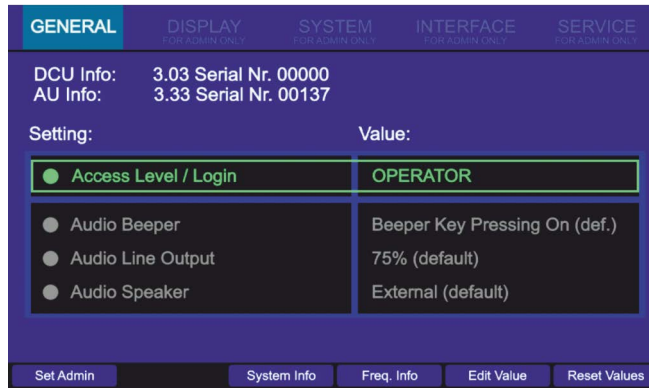

Fig. 66 Setup page, General settings appearance for the access level "Operator"

Administrator:

The Administrator has the maximum access to the possible settings (except a set of settings, which are predefined for RHOTHETA specialists for maintenance and support purposes). After powering on the system for the first time, the device will be started with the default access level "Administrator". It is also possible to set the access level to "Administrator" (e.g., after the hotkey "Set Operator" was pressed) using the default password:

admin

All essential settings of the system, that have a direct influence on the bearing, must be done by authorized personnel.

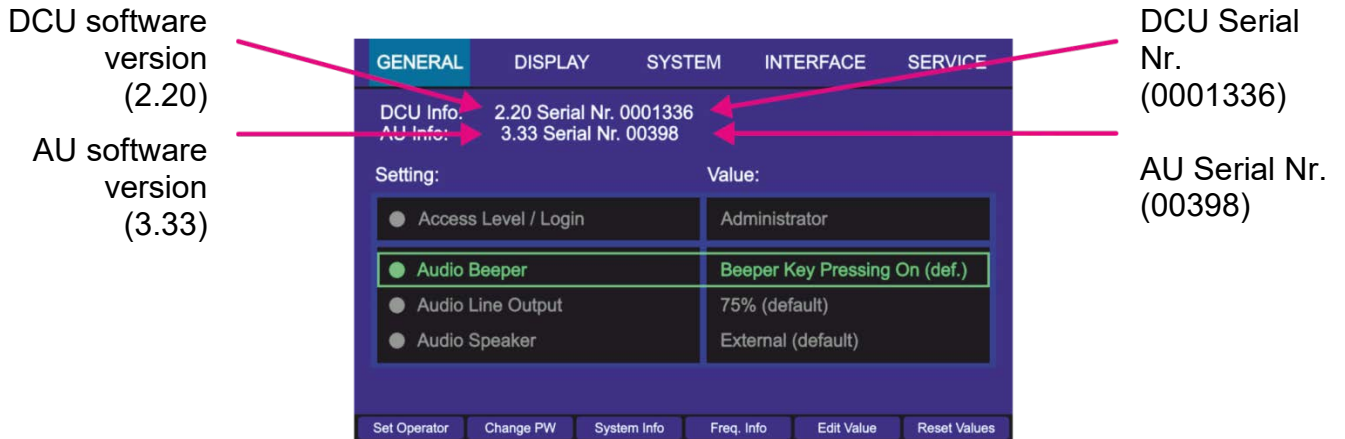

Fig. 67 Setup page, General settings appearance for the access level "Administrator"

Note

After the setting up of the system, it is recommended to change the password from default to a new value (s. 6.4.1.6) and set the access level to "Operator" (s. 6.4.1.7). The access level is then stored permanently on the device and remains after the restart of the device.

6.4.1.2 Audio Beeper

Pressing any key of the DCU keypad produces a short beep.

This behavior is defined as the default setting for “Audio Beeper” after the first booting of the DCU. The acoustic reaction on the key pressing can be changed anytime in the setup menu “General”.

Setting for the beeper can be changed by pressing “OK” or the hotkey “Edit Value”, while the line “Audio Beeper” is marked. Both actions call up the same dialog (s. 6.4.1.7, Edit value for setting “Audio Beeper”).

Pressing the hotkey “Beep On/Off” will directly switch between the “On” and “Off” settings.

6.4.1.3 Audio Line Output

Audio line output signal can be found at the POWER + IO connector. It can be used for connection to the audio system of the vessel.

The level of the line out signal is adjustable from 0% to 100% (s. 6.4.1.7, Edit value for setting “Audio Line Output”). Audio line exit has a determined output level and is independent of the volume adjustment.

6.4.1.4 Audio Speaker

The RT-800 DCU has an internal speaker that can be used to monitor the audible signals or acoustic alarms. Alternatively, the external speaker can be used e.g., for release an alarm on the ship.

6.4.1.5 Set Operator / Set Admin Dialog

If the “Administrator” access mode is currently active and the hotkey “Set Operator” is pressed, it will instantly set the access level to “Operator” without asking for permission or password. The appearance of the “Setup” page will change immediately, and the hotkey designation will change to “Set Administrator.”

If the “Operator” access mode is active, pressing the hotkey “Set Admin” will open the “Input Password” dialog, where either the default or the own (previously changed from the default) password should be entered into the “Input Password for Administrator” field.



Fig. 68 Accessing the administrator level

After the input of the password is complete it should be confirmed using the “End of User Input” button.

The validity message: “Password valid, press OK!” or “No valid password!” will appear.

If the password is not valid, delete the input (s. Fig. 68, “Input delete key”) and proceed with the next try.

If the password is valid, by confirming with “OK” the administrator access level will be achieved.

6.4.1.6 Change Password Dialog

Pressing the hotkey “Change PW” (s. Fig. 69) will open the dialog for changing the current (or default) administrator access level password. This hotkey is only visible in the administrator access mode.

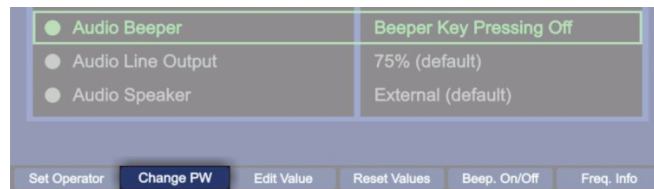

Fig. 69 Changing password

Continue with the next instructions in order to change the password.

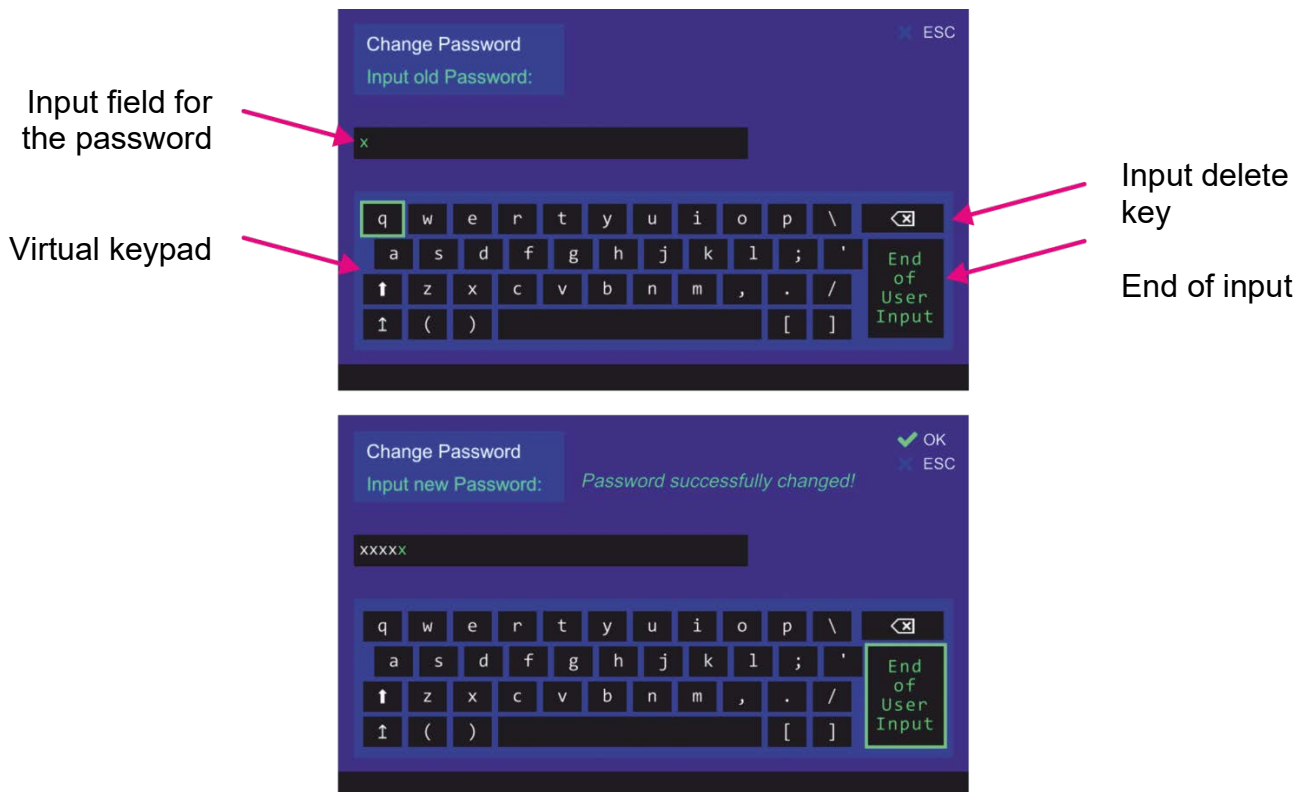

Fig. 70 Changing the administrator password

First, the old password will be requested (“Input old Password”).

If the input is correct, the new password will be requested in the next step (“Input new Password”).

The password change dialog can be canceled by pressing "ESC" at any step, except after confirming the new password value.

If all the inputs are correct and confirmed, the message “Password successfully changed!” will appear (s. Fig. 70) and the dialog can be left by pressing the “OK” button.

6.4.1.7 Edit Value Dialog

Depending on the currently marked line, pressing the hotkey “Edit Value” (s. Fig. 65, position 5) will lead to the corresponding dialog.

Edit value for setting “Access Level /Login”



Fig. 71 Edit value dialog for access level

1. Pressing the hotkey “Set Admin” will lead to the “Set Admin” dialog, where the password input is required (s. 6.4.1.5). Pressing the hotkey “Set Operator” will change the “New Access Level /Login” field to access level “Operator” (s. Fig. 72):

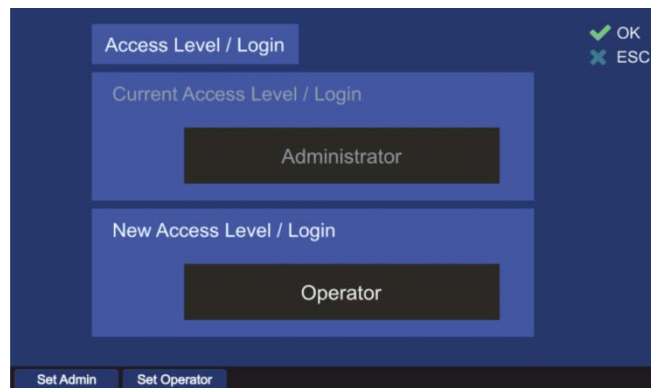

Fig. 72 Editing the access level to "Operator"

2. By pressing “OK” the new access level will be accepted and pursued. Pressing “ESC” closes the dialog and administrator access level will be retained.

Edit value for setting “Audio Beeper”

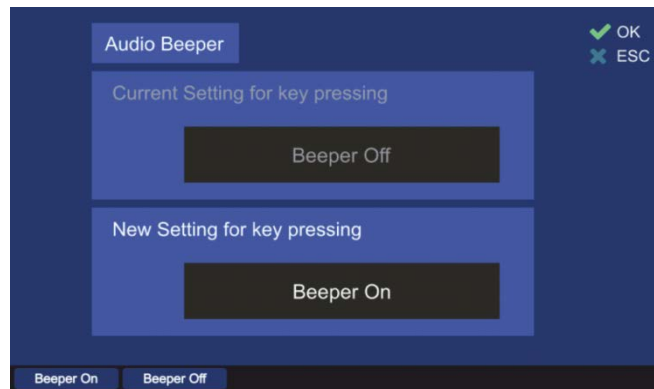

Fig. 73 Editing the value for the audio beeper

1. Pressing the hotkey “Beeper On” or “Beeper Off” will write the corresponding message into the “New Setting for key pressing”.
2. By confirming with “OK” the setting will be accepted, and the dialog will be closed. For discarding the changes press “ESC” at any step and escape the dialog without saving the new value.

Edit value for setting “Audio Line Output”

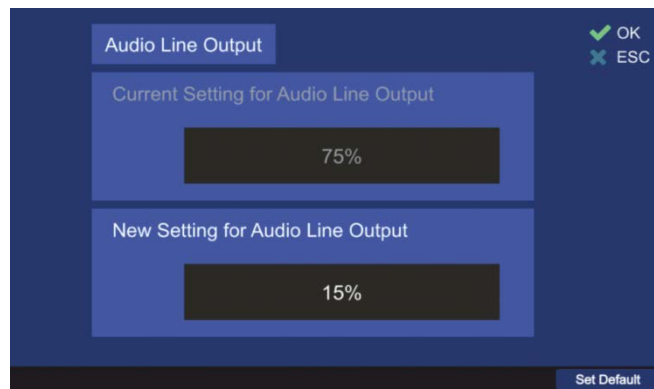

Fig. 74 Edit value of the audio line output level

1. In the edit value dialog, the level of the audio line output in percent can be changed using the numeric keys of the DCU keypad.
2. Pressing the “Set Default” hotkey will set the line output to the default value of 75%.
3. Press “OK” to confirm the input and leave the dialog. For discarding the settings, press “ESC” at any step and escape the dialog without saving the new value.

Edit value for setting “Audio Speaker”

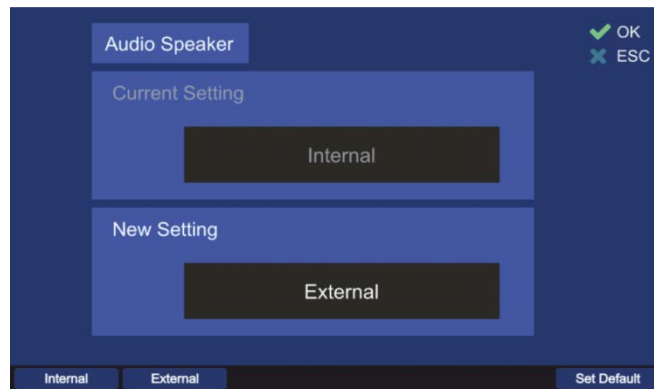

Fig. 75 Edit value for the speaker

1. Pressing the hotkey “Internal” or “External” will write the corresponding message into the “New Setting” field.
2. By confirming with “OK” the setting will be accepted, and the dialog will be closed. For discarding the settings, press “ESC” at any step and escape the dialog without saving the new value.

6.4.1.8 Frequency Information Dialog

After pressing the hotkey “Freq. Info” (s. Fig. 65, position 4) the frequency information dialog opens.

The frequency information is presented in the form of a list of the available and not available frequency bands.

| Available Frequency Bands: | Status: |
|--|---------------|
| Std.:VHF Emergency Band [118.000 ... 124.000] MHz | Available |
| Std.:VHF Marine Band [154.000 ... 163.000] MHz | Available |
| Std.:UHF Emergency Band [240.000 ... 246.000] MHz | Available |
| Std.:COSPAS-SARSAT [400.000 ... 406.092] MHz | Available |
| Std.:UHF FM Band [406.100 ... 410.000] MHz | Available |
| F1: VHF Air Band [118.000 ... 136.992] MHz | Not available |
| F2: Ext. VHF Marine Band [137.000 ... 224.995] MHz | Not available |
| F3: UHF Air Band [225.000 ... 399.975] MHz | Not available |
| F4: Additional UHF FM Band [406.100 ... 470.000] MHz | Not available |

Available: Licensed for DCU and AU Std.: Standard Range
 Not available: Not licensed for DCU and / or AU F1 ... F4: Optional Range
 Locked frequencies s. under „See Locks”

See locks

Explanation of the status indication

Explanation of the abbreviations

Hotkey for additional information about locked frequencies

Fig. 76 Frequency information dialog

- The frequency bands that are marked with „Std.” are basic frequency ranges. These frequencies are always licensed in the standard version of RT-800 and thus always appear as “Available”.
- The frequency ranges designated with “F1 ... F4” are optional extended ranges. In the standard version of RT-800, they are not licensed and thus marked as “Not available”. These optional frequency bands can be acquired separately (please contact RHOTHETA Elektronik GmbH).
- However, it is possible to lock some particular frequencies as well as certain frequency bands, if these are licensed. After a frequency has been locked by the user, it will not be possible to set this frequency for the bearing operation.
- Locking of frequencies is the responsibility of the administrator.

The operator can only view the frequencies which have been locked by the administrator.

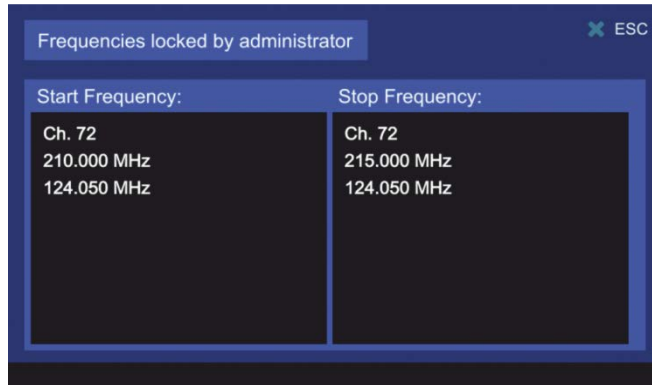

Fig. 77 Locked frequencies. Operator view

Locked frequencies can be viewed in the embedded separate dialog, which is available over the hotkey “See locks” (s. Fig. 76).

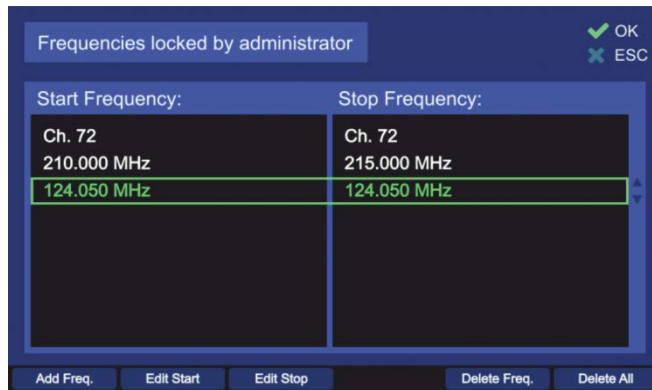

Fig. 78 Locked frequencies. Administrator view

Lock / Unlock Frequencies Procedure

Locking or unlocking of frequencies is only available over the administrator access level. To mark any frequency as locked/unlocked following steps are required:

- 1) Press the “See locks” hotkey in the “Freq. Info” dialog. The window, which is shown in Fig. 78 appears.
- 2) To lock a single frequency, press the hotkey “Add Freq.” The “Frequency input” dialog appears (for further information s. 6.1.2.2), where a frequency, channel number or a Cospas-Sarsat frequency can be entered. After confirming with “OK” a single frequency is added. It appears then in the list of locked frequencies as “Start Frequency” as well as “Stop Frequency”.
- 3) To lock a certain frequency band proceed with step 2), adding the start frequency first. Then by pressing “Edit Stop” hotkey the last frequency of the to-be-locked band can be entered. In the same way, the start frequency can be changed using the “Edit Start” hotkey.
- 4) Unlocking (deleting) of a frequency or a frequency band is accomplished with pressing the hotkey “Delete Freq.”

Note

Pressing this hotkey will delete the marked frequency immediately without asking for confirmation!

- 5) To unlock the whole list of frequencies, use the hotkey “Delete All”. The difference to deleting the single frequency or frequency band is that for leaving the dialog the action has to be confirmed with “OK”.

Note

If after deleting all locked frequencies the dialog will be left by pressing “ESC”, the dialog will be closed without saving any changes. That means, the list will not be deleted and is accessible again after pressing the hotkey “See locks”.

6.4.1.9 System Info Dialog

This dialog provides important information about the status (revision) of the used system components (s. Fig. 79). This information may be helpful in service or remote support cases.

To view the system information press the hotkey “System Info” (s. Fig. 65, position 3) and skip between the items with “Up” and “Down” arrow buttons of the DCU keyboard.

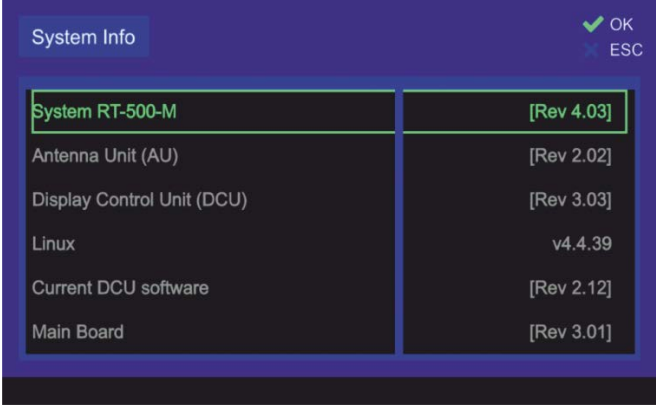

| System RT-500-M | [Rev 4.03] |
|----------------------------|------------|
| Antenna Unit (AU) | [Rev 2.02] |
| Display Control Unit (DCU) | [Rev 3.03] |
| Linux | v4.4.39 |
| Current DCU software | [Rev 2.12] |
| Main Board | [Rev 3.01] |

Fig. 79 "System Info" dialog

6.4.2 Display

On the “Setup” page, the “Display” menu can be selected via the administrator access level only (by pressing the “Display” hotkey on the navigation line, s. Fig. 80, position 11).

The “Display” page enables modifying of settings that affect the graphical representation of the application.

After pressing the “Display” navigation key, following menu page opens (s. Fig. 80).

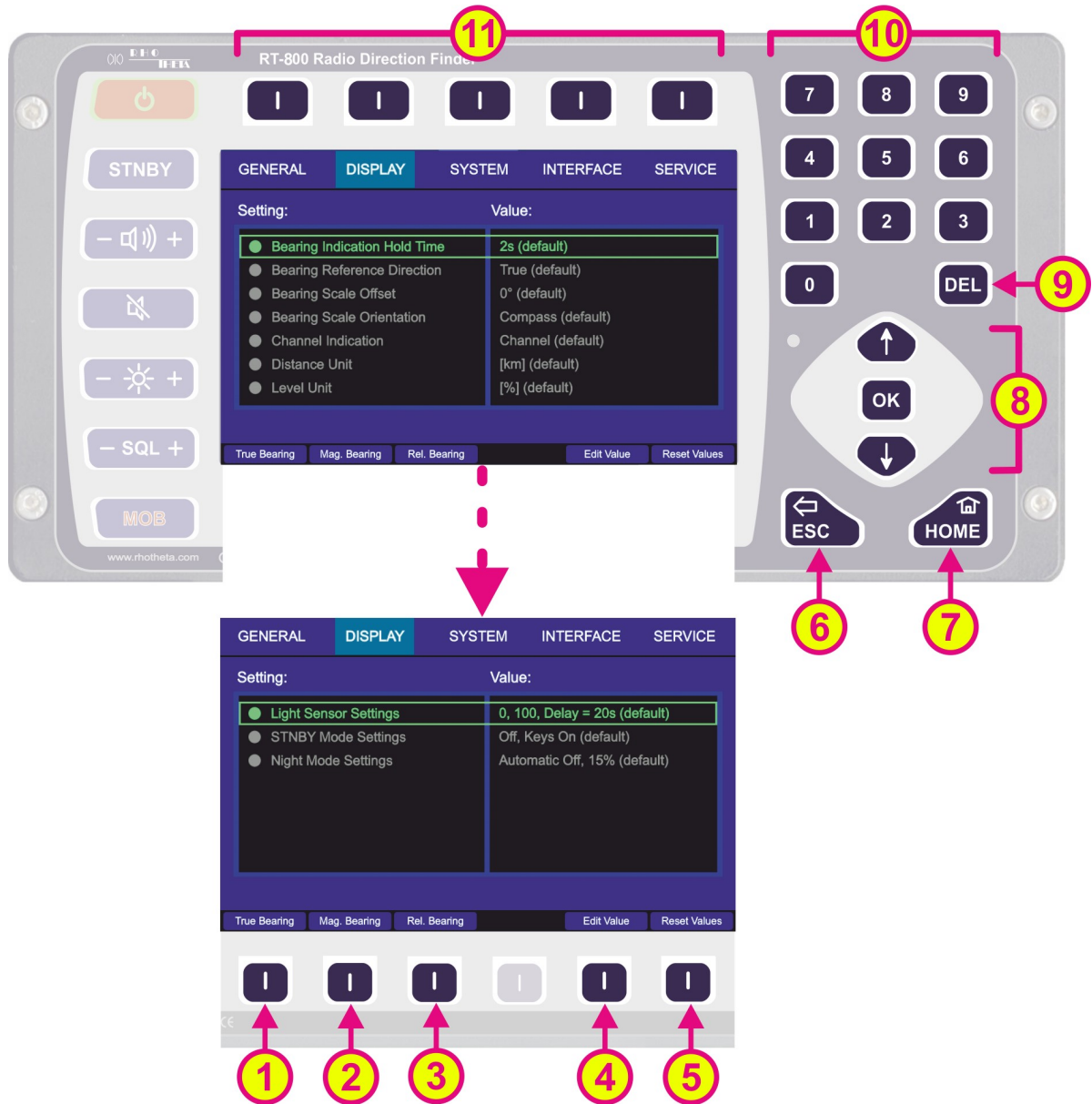

Fig. 80 Setup page. Display settings

| Indication on Setup Page, Display Settings | | |
|--|----------------|---|
| Pos. | Element | Meaning / Description |
| 1 | “True Bearing” | Sets the bearing reference direction to “TRUE” without opening the corresponding dialog (s. Table 6. Bearing reference directions). |





| | | |
|----|---|--|
| 2 | "Mag. Bearing" | Sets the bearing reference direction to "MAGNETIC" without opening the corresponding dialog (s. Table 6. Bearing reference directions). |
| 3 | "Rel. Bearing" | Sets the bearing reference direction to "RELATIVE" without opening the corresponding dialog (s. Table 6. Bearing reference directions). |
| 4 | "Edit Value" | Depending on currently marked line, using this hotkey will open the dialog for changing the corresponding value (s. descriptions in the subsequent chapters). |
| 5 | "Reset Values" | Resets all values to the default settings (s. 13.4). The default values themselves cannot be changed by the user (RHOTHETA specification). |
| 6 |  | When there is a dialog opened, pressing this button will close the dialog without adopting new values. When there is no dialog opened, pressing this button will go back to the last activated page. The "Bearing" page is the endpoint. |
| 7 |  | Pressing this button always leads to the Bearing Page. Even an opened dialog will be closed, without adopting the changed values. |
| 8 |  | "Up" and "Down" arrows are used to move between the display settings. "Right and "left" arrows have no function inside the display settings page. With the "OK" button confirming of values or opening the display settings dialogs is accomplished. |
| 9 |  | Inside the display settings dialogs, the "DEL" button is used to clear the whole input at once. On the top level of this page, this button has no function. |
| 10 |  | Numeric keys are used to enter the numerical characters inside the dialogs. On the top level of the page, they have no function. |
| 11 | Top line | Navigation line of the screen, which allows switching between setup menus ("General", "Display", "System", "Interface" and "Service"). |

Table 13 Setup page, display settings. List of elements

6.4.2.1 Bearing Indication Hold Time

The “bearing indication hold time” defines how long the bearing value is indicated after the signal fell under the squelch level.

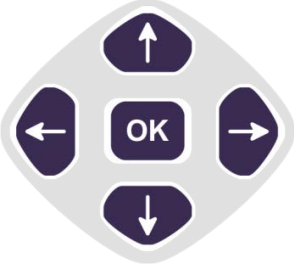
If there is no more valid bearing information available, the last bearing data (bearing arrow, life values and digital bearing display) is displayed on the “Bearing” page for a defined period of time. This time is set to 2 seconds by default and configurable via this setting.

By pressing the “OK” button or the hotkey “Edit Value” (s. Fig. 80, positions 4 or 8), the following dialog is opened.

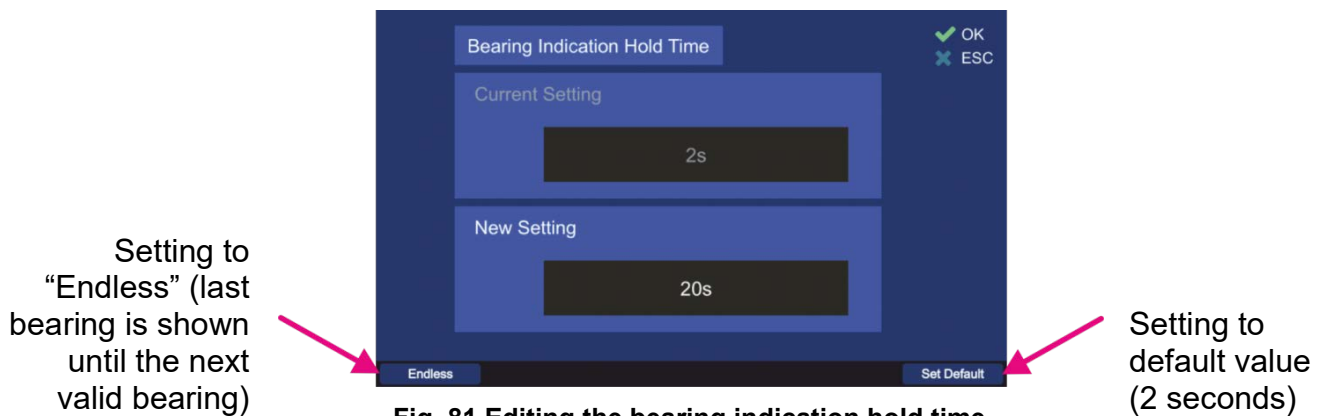

Fig. 81 Editing the bearing indication hold time

- The new value for the bearing hold time can be entered in the input field “New Setting”, using the numeric keys of the keypad.
- Use the hotkey “Endless” to set the bearing hold time to an “endless” value, which means that (after the signal was interrupted) the last valid bearing information will be shown as long as the new valid bearing needs to arrive.
- To set the bearing hold time to the default value (2 s), press the hotkey “Set Default”.
- For the final confirmation, press “OK” or use the “ESC” button to leave the dialog without adopting the new value.

6.4.2.2 Bearing Reference Direction

The bearing reference direction is significant for the bearing indication. The direction of the bearing arrow in the 360° display (and compass rose indication) is always referred to a defined point in space.

This reference point can be the **magnetic** north position, **true** north position and **relative** (reference is the direction to the vessels bow). For further explanation refer to chapter 6.1.2. Pressing “OK” or “Edit Value” (s. Fig. 80, positions 4 or 8) while the line “Bearing Reference Direction” is marked opens the corresponding dialog.

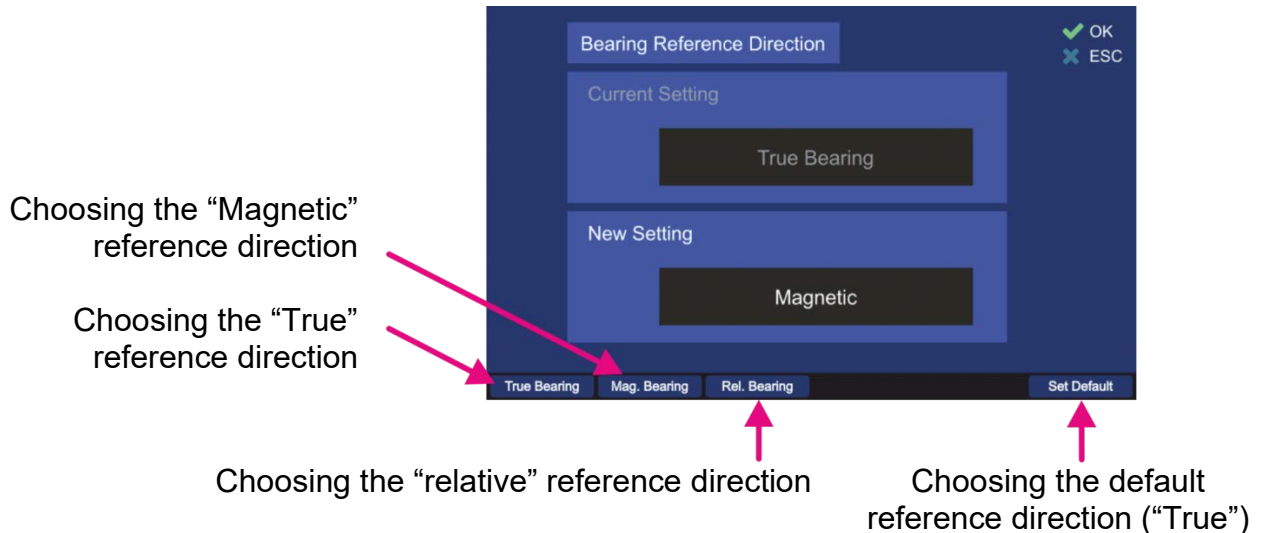

Fig. 82 Bearing reference direction dialog

- Press the hotkey “True Bearing” to set the bearing reference direction relative to true (geographic) north (only if compass data is available). If no compass data is available, the bearing page will not adopt the “True” setting. The relative bearing and “No Compass” warning will be shown.
- Press the hotkey “Mag. Bearing” to set the bearing reference direction relative to magnetic north (only if compass data is available). If no compass data is available, the bearing page will not adopt the “Magnetic” setting. The relative bearing and “No Compass” warning will be shown.
- Press the hotkey “Rel. Bearing” to set the bearing reference direction relative to the heading of the vessel (for mobile installation) / to North/0° alignment of the antenna (for permanent installation).

Note

If the “Rel. Bearing” reference direction is chosen and the compass data is available, then the heading (value in the triangle on the top of the bearing rose) will change its value according to the compass data.

- Press “Set Default” to use the default value (true north direction, only if compass data is available).
- To save the changed value, press “OK”.
- Pressing the “ESC” button will leave the dialog without adopting the changed value.

6.4.2.3 Bearing Scale Offset

In this menu an offset for the bearing rose can be set. This is useful for better visual comprehension of the bearing direction indication. It can be used, for instance, if the window of the vessel’s control cabin shows to another direction than the bow of the ship and it is desired to take this direction as the relative direction.

After setting the bearing scale offset to a certain value that differs from 0°, the bearing rose will turn according to this value.

To set the bearing scale offset, press “OK” or “Edit Value” (s. Fig. 80, positions 4 or 8) while the line “Bearing Scale Offset” is marked. The corresponding dialog will open.

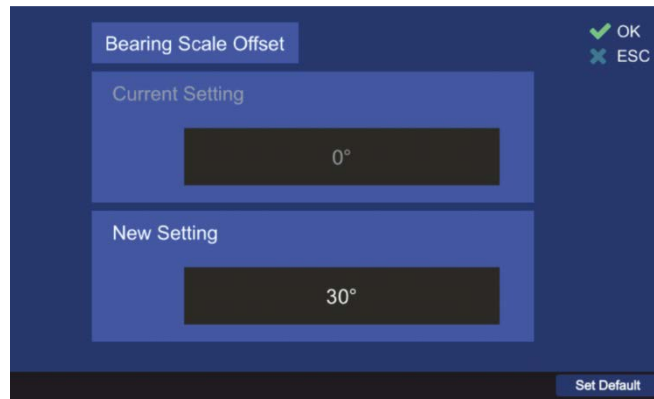

Fig. 83 Bearing scale offset editing dialog

- Type any value in the “New Setting” input field by using the numeric keys of the keypad to set the value of the scale offset.
- Press the hotkey “Set Default” to set the default value for the bearing scale offset (0°).
- Confirm the changed value with “OK” or press “ESC” to leave the dialog without changing the previous value.

6.4.2.4 Bearing Scale Orientation

The bearing scale orientation is another setting for the graphical representation of the bearing value, which is convenient for the two different types of use of the RT-800 DF system: mobile use or fixed (permanent) installation (s. 6.4.3.4).

“Compass” (default setting), and the “Static (North Up)” are possible to select.

If “Compass” is used as “Bearing Scale Orientation”, the heading pointer shows a value in [°] that corresponds to the current alignment in space and the compass rose rotates accordingly to the compass data (please ensure that the compass orientation matches with the antenna orientation).

If “Static (North Up)” is used as “Bearing Scale Orientation”, the indication inside the heading pointer will be “N up” regardless of the “Bearing Reference Direction”. The 360° display/compass rose stays fixed in this position also regardless of the “Antenna North Adjustment” setting (s. under Setup/System).

To set the bearing scale orientation, press “OK” or “Edit Value” while the line “Bearing Scale Orientation” is marked. The corresponding dialog will open.

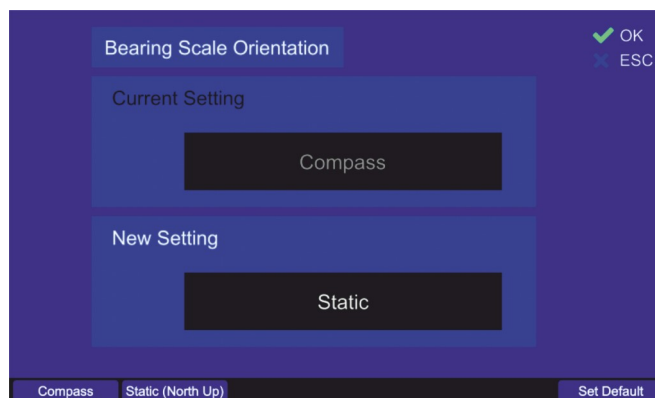

Fig. 84 Bearing scale orientation editing dialog

- Pressing the hotkeys “Compass” or “Static (North Up)” selects the corresponding value for the “New Setting” field.

- Press the hotkey “Set Default” to set the default value for the bearing scale orientation (“Compass”).
- Confirm the changed value with “OK” or press “ESC” to leave the dialog without changing the previous value.

6.4.2.5 Channel Indication

It is possible to configure the indication of frequency/channel, which is then shown on the “Bearing” page, in the left upper corner of the display (s. Fig. 85).

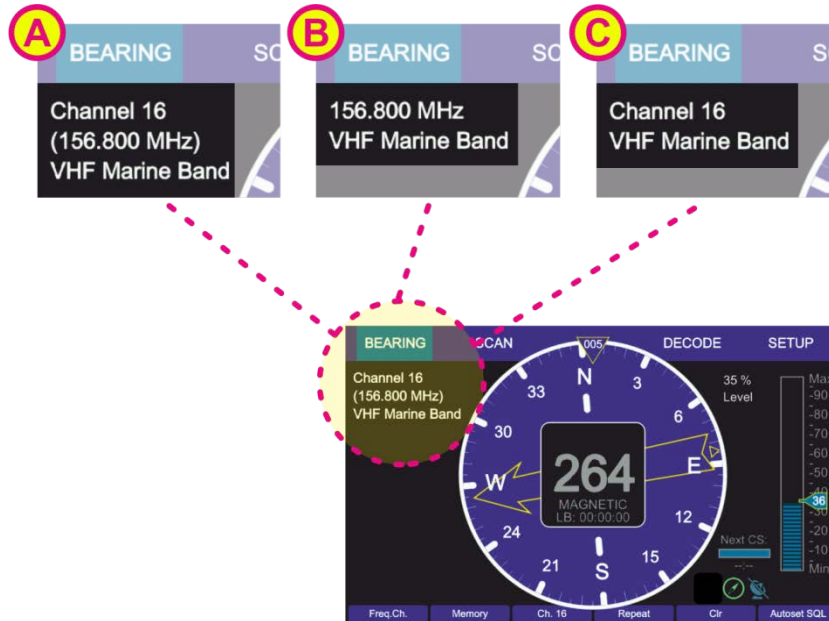

Fig. 85 Types of the frequency/channel indication

To change the type of frequency/channel indication, press “Edit Value” or “OK” (s. Fig. 80, positions 4 or 8) while the line “Channel Indication” is marked. The corresponding dialog will open (s. Fig. 86).

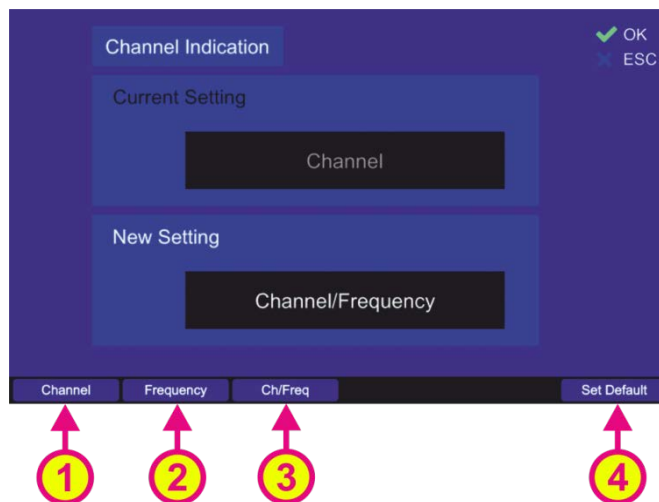

Fig. 86 "Channel Indication" dialog

- Choose the desired type of frequency/channel indication pressing one of the hotkeys:

- “Channel” (s. Fig. 86, position 1): the corresponding appearance on the “Bearing” page will be as shown in Fig. 85, field C.
 - “Frequency” (s. Fig. 86, position 2): the corresponding appearance on the “Bearing” page will be as shown in Fig. 85, field B.
 - “Ch/Freq” (s. Fig. 86, position 3): the corresponding appearance on the “Bearing” page will be as shown in Fig. 85, field A.
- Press the hotkey “Set Default” to set the default value for frequency/channel indication (“Channel”).
 - Confirm the changed value with “OK” or press “ESC” to leave the dialog without changing the previous value.

6.4.2.6 Distance Unit

The indicating of distances can be either in kilometers [km] or in nautical miles [NM]. The default value is “[km]”.

To change the indication of the distance unit, press either the “OK” or “Edit value” (s. Fig. 80, positions 4 or 8) while the setting is marked by the green frame.

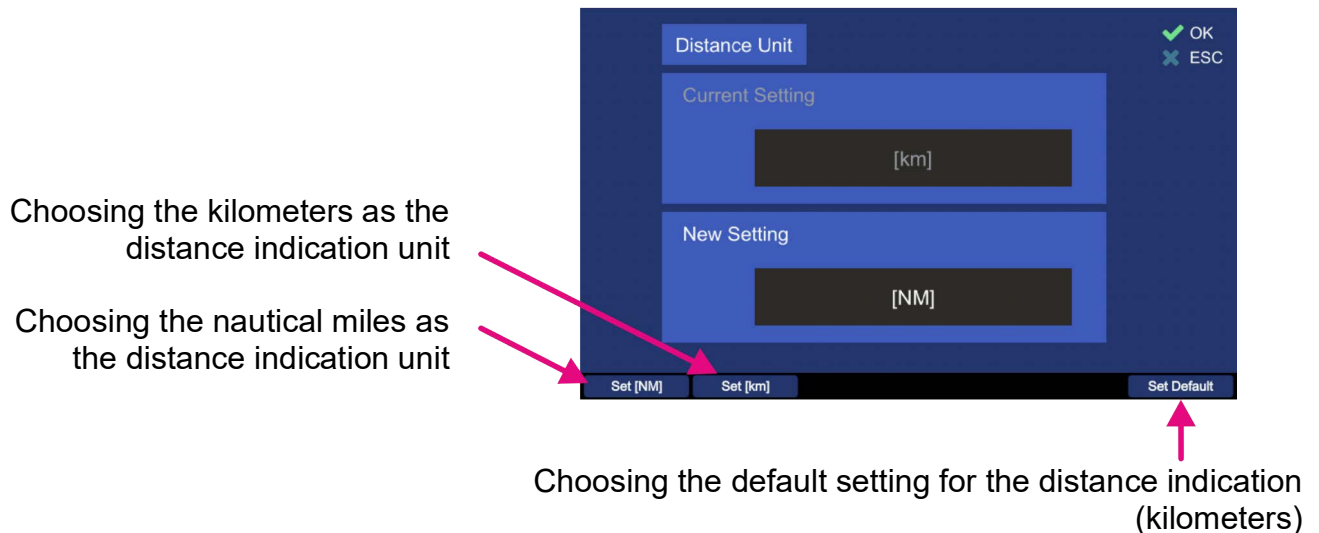

Fig. 87 Changing the distance unit

- Press the hotkey “Set [NM]” to set the distance unit to “[NM]” (Nautical Miles). Each distance indication in the application will be indicated in nautical miles.
- Pressing the hotkey “Set [km]” will set the distance unit to “[km]” (kilometers). Each distance indication in the application will be indicated in kilometers.
- Press the hotkey “Set Default” to set the distance indication to the default value (kilometers).
- Confirm the changed value with “OK” or press “ESC” to leave the dialog without changing the previous setting.

6.4.2.7 Level Unit

Indicating of levels (like signal level, or squelch level) can be either in “[%]” or in “[dB]”.

To change the currently chosen unit for the levels indication press either the button “OK” (s. Fig. 80, positions 4 or 8) or “Edit Value”, during the setting “Level Unit” is marked.

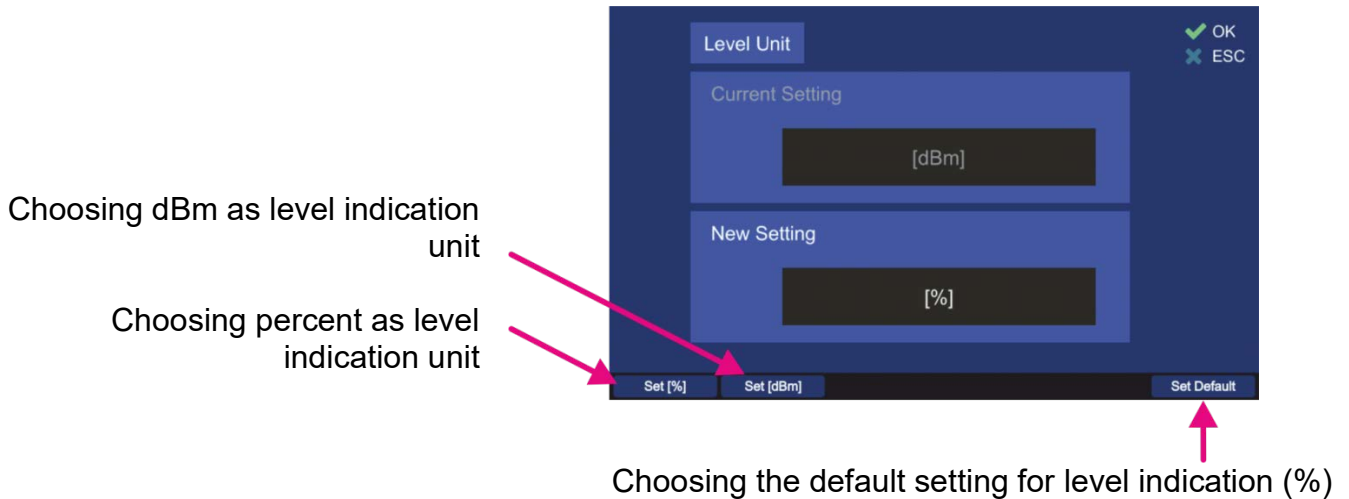

Fig. 88 Changing the level unit

- Press the hotkey “Set [%]” to set the level unit to “[%]” (percent). Each level indication in the DCU application will be indicated in percent.
- Pressing the hotkey “Set [dBm]” will set the level unit to “[dBm]”. Each level indication in the application will be indicated in dBm.
- Press the hotkey “Set Default” to set the distance indication to the default value (%).
- Confirm the changed value with “OK” or press “ESC” to leave the dialog without changing the previous setting.

6.4.2.8 Light Sensor Settings

The light sensor is used in the DCU to adjust the brightness of the display, legends and “Keys” (s. 6.5.4) automatically according to the ambient light level.

In this menu point, which contains three settings, the characteristics of the light sensor can be defined.

After pressing “OK” or “Edit Value” (s. Fig. 80, positions 4 or 8) while the menu point “Light Sensor Settings” is marked, the following dialog opens.

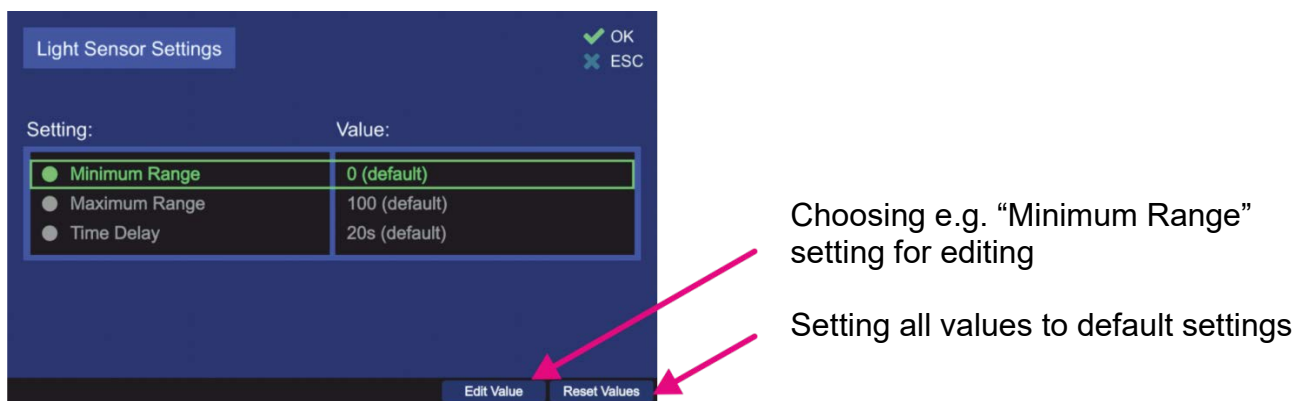

Fig. 89 Light sensor settings

With the minimum / maximum range settings one can influence the spacing of changing the brightness of display, legends or “Keys”.

- Other than with other dialogs of the “Display” menu, editing of the values is only available over the “Edit Value” hotkey (pressing “OK” is valuated as accepting of the present values and will lead out of the dialog).

- Leaving the top level dialog (s.Fig. 89) always press “OK” for the second time (after confirming the actual setting), otherwise, the changed settings will not be adopted.

Minimum Range

The minimal value of the light sensor is “0” (default value).

To change this value, press the hotkey “Edit Value”, while “Minimum Range” is marked.

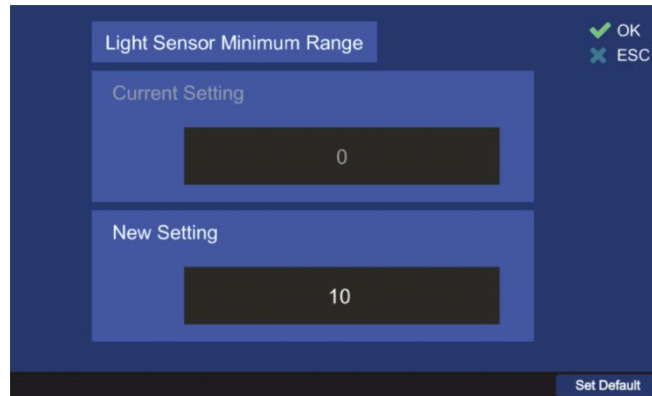

Fig. 90 Changing the minimum range value of the light sensor

- Type the new value for the minimum range of the light sensor in the “New Setting” input field, using the numeric buttons of the DCU keypad.
- Use the “Set Default” hotkey to reset the value to the default setting.
- Confirm the changed value with “OK” or press “ESC” to leave the dialog without changing the previous setting.

Maximum Range

The maximal value of the light sensor is “1000”.

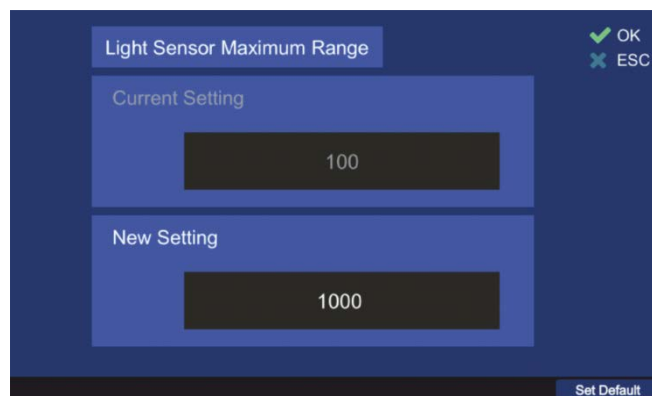

Fig. 91 Changing the maximum range value of the light sensor

- Type the new value for the maximum range of the light sensor in the “New Setting” input field, using the numeric buttons of the DCU keypad.
- Use the “Set Default” hotkey to reset the value to the default setting.
- Confirm the changed value with “OK” or press “ESC” to leave the dialog without changing the previous setting.

Time Delay

This setting determines how fast the system brightness reacts to the changing of ambient brightness.

The adjustable range is between 0 s and 999 s.

Recommended value is the default value of 20 seconds, which ensures that e.g. the shadow of a person that quickly passes by, influences the brightness of the system.

To change this value, press the hotkey “Edit Value”, while “Time Delay” is marked.

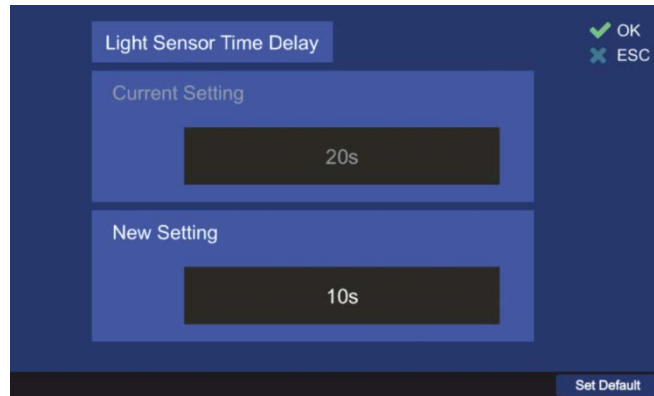

Fig. 92 Changing the time delay value for the light sensor

- Type the new value for the delay value of the light sensor in the “New Setting” input field, using the numeric buttons of the DCU keypad.
- Use the “Set Default” hotkey to reset the value to the default setting.
- Confirm the changed value with “OK” or press “ESC” to leave the dialog without changing the previous setting.

6.4.2.9 Standby Mode Settings

This menu point defines the display brightness and key illumination during the standby mode.

To change the standby settings, press the “Edit Value” hotkey (s. Fig. 80, positions 4), while “Standby Brightness” is marked.

Following dialog appears (s. Fig. 93).

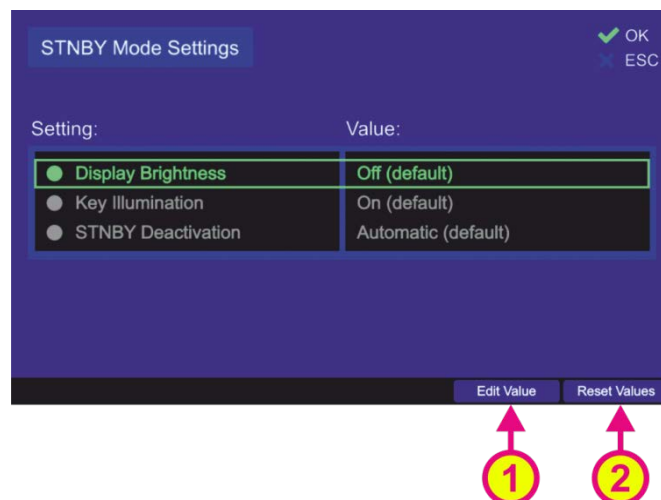

Fig. 93 Standby mode settings dialog

Note

If you press "OK" in this view, the current settings will be interpreted as the ones to be saved, which will cause the dialog to close, saving these values.

In order to change the single settings always use the "Edit Value" hotkey (s. Fig. 93, position 1).

Note

Pressing the "Reset Values" hotkey resets all settings that are displayed in this view to their default values. If the "OK" button is used then to leave the dialog, the default values will be saved.

Display Brightness

This setting defines, which brightness value the display will take in the standby mode.

To change this value press the "Edit Value" hotkey, while "Display Brightness" is marked.

Following dialog opens (s. Fig. 94).

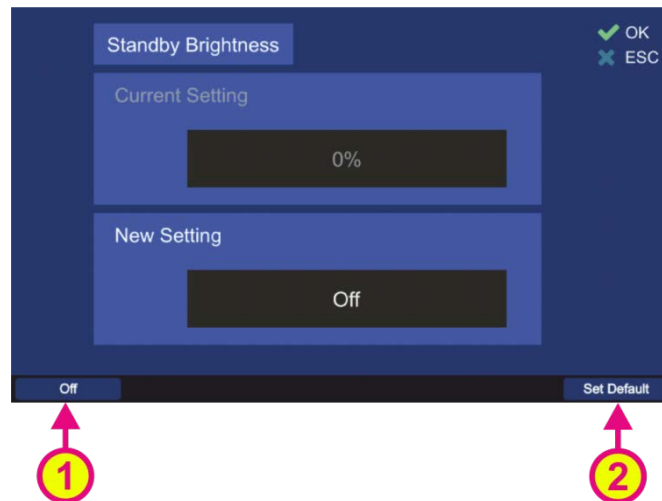

Fig. 94 Adjusting the standby brightness

- Type the new value for the standby brightness value in the "New Setting" input field, using the numeric buttons of the DCU keypad or use the hotkey "Off" (s. Fig. 94, position 1) in order to set the standby brightness to a "black screen"-value. If the setting "Off" is confirmed with "OK", the display will be turned off after the button "Standby" is pressed.
- Use the "Set Default" hotkey (s. Fig. 94, position 2) to reset the value to the default setting (Off).
- Confirm the changed value with "OK" or press "ESC" to leave the dialog without changing the previous setting.

Key Illumination

This setting defines the behavior of the keys (colored illumination of the function keys "Power", "Mute" and "Standby") in standby mode.

- If "Off" is set, the key illumination is turned off after the button "Standby" is pressed.
- If the setting "On" is chosen, the illumination of the keys stays at the brightness value, which was previously defined (s. 6.5.4).
- With the setting "Flashing" the keys blink in the standby mode.

To change this setting value press the "Edit Value" hotkey (s. Fig. 93), while "Display Brightness" is marked.

Following dialog opens (s. Fig. 95).

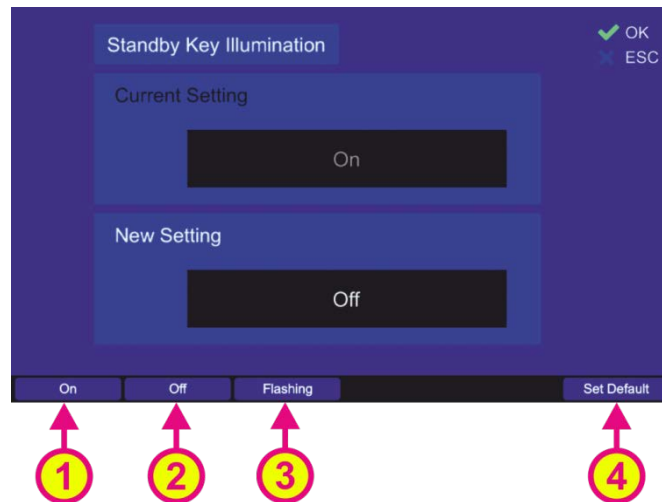

Fig. 95 Changing the standby key illumination setting

- Choose the “On”, “Off” or “Flashing” hotkey to set the desired variant of the key illumination (s. Fig. 95, positions 1, 2 or 3).
- Use the “Set Default” hotkey (s. Fig. 95, position 4) to reset the value to the default setting (Off).
- Confirm the changed value with “OK” or press “ESC” to leave the dialog without changing the previous setting.

STNBY Deactivation

This setting defines, which event can return the RT-800 device from the standby mode to the normal operation.

- If “Automatic” is set, the device will get back to the normal operation by the occurrence of an event, e.g. reception of a valid signal (s. 6.5.1).
- If “User” is set, the standby mode can only be deactivated manually by pressing any key (except the On/Off (“Power”) button).

Note

To completely turn off the DCU’s illumination in the “Dark Mode”, the settings “Display Brightness” and “Key Illumination” must be set to “Off”. This means that the DCU remains dark even if a signal is received.

The communication with the DCU in this mode can be maintained over NMEA or LAN interfaces (using NMEA data protocol), if desired.

Note

If the “Dark Mode” is activated while either the main bearing frequency is an emergency frequency or a scan with any emergency frequency is active, the occurrence of the corresponding signal will be indicated by the acoustic alarm even in the “Dark Mode”.

To switch off the alarm in this case, the device must first be returned to the normal operation, or a corresponding NMEA sentence (“ALARMCFM”, for more information s. “NMEA Protocol Description RT-800”) can be sent out over the NMEA interface to confirm the alarm.

Note

Do not use the “Power” button in order to return the DCU from the “Standby Mode” into normal operation!

Pressing the “Power” button for about 2 seconds leads to switching off the DCU and after restarting the device, it works in the normal operation mode (with normal display brightness).

To change the “STNBY Deactivation” value, press the “Edit Value” hotkey (s. Fig. 93), while “STNBY Deactivation” is marked.

Following dialog opens (s. Fig. 96).

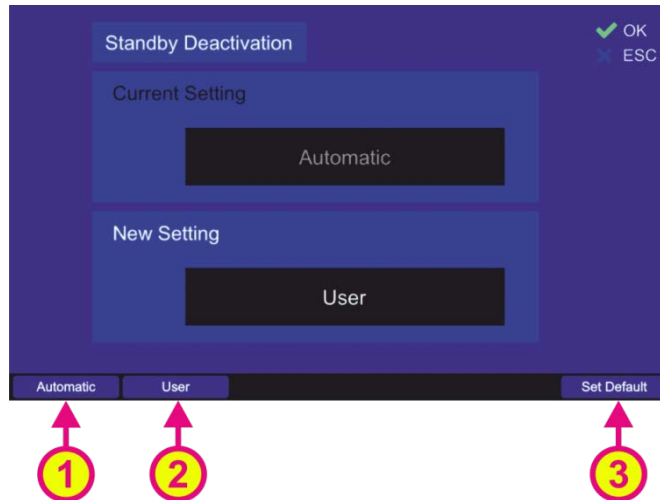

Fig. 96 Changing the standby deactivation setting

- Press the hotkey “Automatic” (s. Fig. 96, position 1) in order to enable the automatic standby mode deactivation.
- Press the “User” hotkey in order to deactivate the standby mode manually.
- Use the “Set Default” hotkey to change to the default setting (“Automatic”).

If the “STNBY Deactivation” setting is changed to “User”, leaving the “Standby Mode Settings” dialog by pressing “OK” will generate a warning (s. Fig. 97) in order to indicate the only manual deactivation of the standby mode from then on.

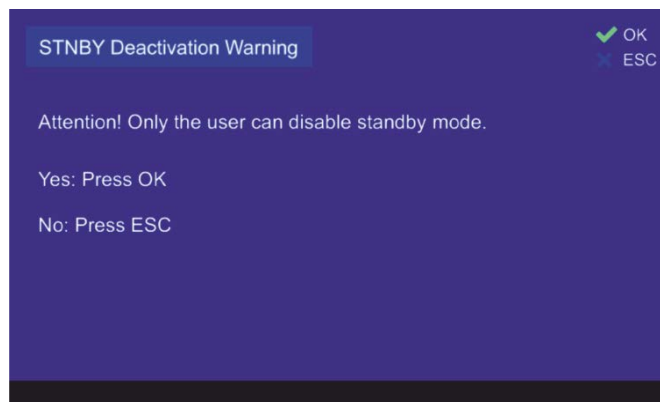

Fig. 97 Dark mode activation warning

If this variant of “Dark Mode” is activated, the “STNBY Mode Settings” line on the “Display” page will show the current settings of the “Display Brightness” and “Key Illumination” (s. Fig. 98).

The result on the “Display” page after pressing “OK” will be as shown in the Fig. 98.

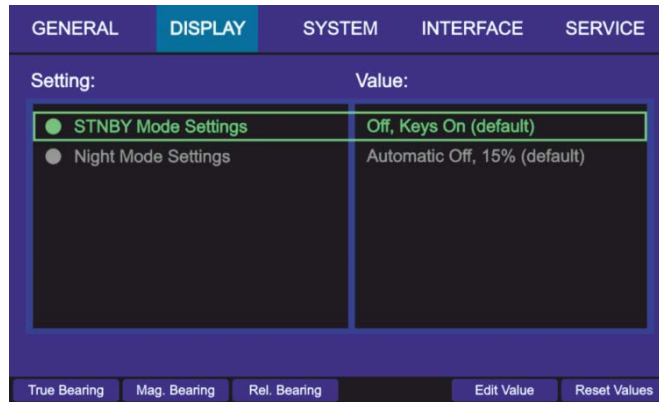

Fig. 98 Manual deactivation of the standby mode is turned on

If the DCU’s illumination is completely turned off for the “Dark Mode”,

- “Display Brightness” and “Key Illumination” are set to “Off” and
- “STNBY Deactivation is set to “User”,

leaving the “Standby Mode Settings” dialog by pressing “OK” will generate a “Dark Mode” warning (s. Fig. 99) in order to indicate that all the device illumination is going to be disabled and only manual deactivation of the standby mode will be possible.

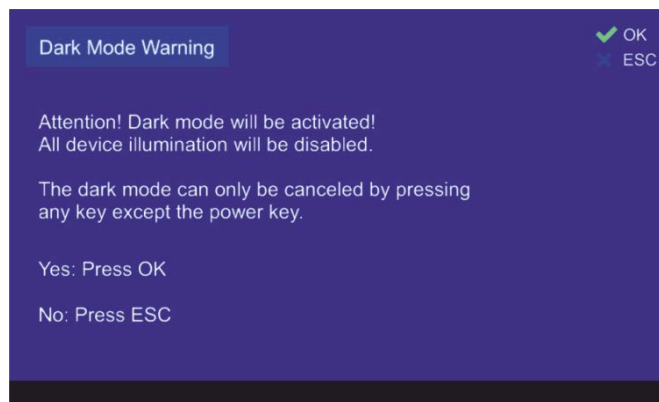

Fig. 99 Activation of the dark mode with disabled illumination

If this warning is accepted by pressing “OK”, the activation of the “Dark Mode” is also indicated on the “Display” page as follows (s. Fig. 100).

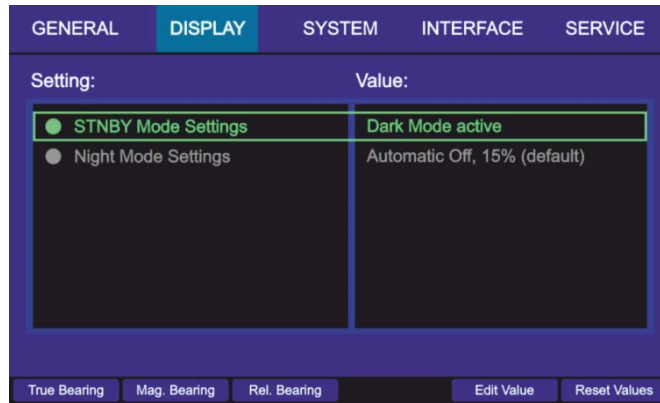

Fig. 100 Dark mode indication on the "Display" page

6.4.2.10 Night Mode Settings

The night mode settings allow the adjustment of the night mode behavior. To change these settings, press the hotkey "Edit Value", while the line "Night Mode Settings" is marked (s. Fig. 101, position 1).

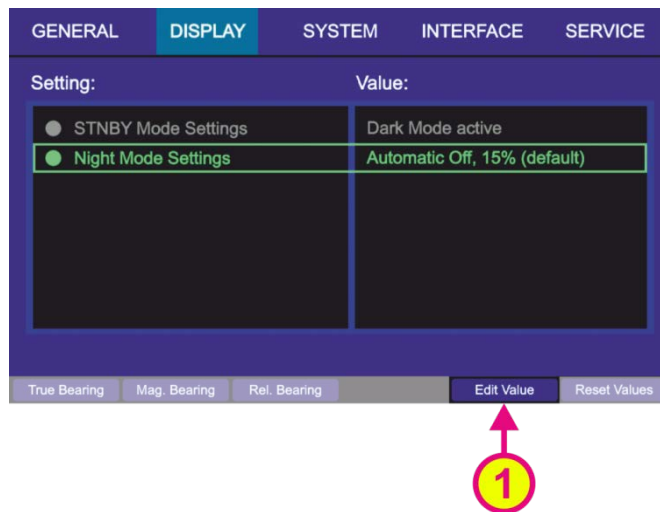

Fig. 101 Selecting the night mode settings

The following dialog opens (s. Fig. 102).

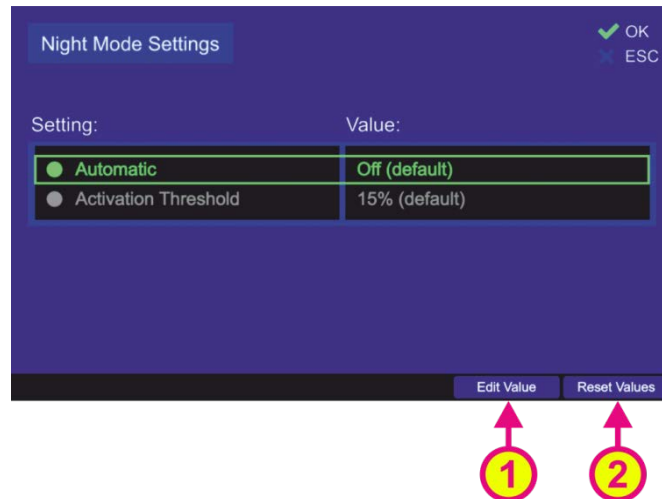

Fig. 102 "Night Mode Settings" dialog

Note

If you press "OK" in this view, the current settings will be interpreted as the ones to be saved, which will cause the dialog to close again, saving these values. In order to change the single settings always use the "Edit Value" hotkey.

Automatic

Defines, whether or not to automatically activate the night mode.

If the automatic activation is turned on, the night mode is activated after 30 seconds when a certain threshold for ambient brightness (measured by the light sensor) is reached. This threshold can be defined with the "Activation Threshold" setting (s. below). The display automatically returns to "Day" mode after 30 seconds when the ambient brightness is above the threshold.

To set the behavior of the night mode to default, press the "Reset Values" hotkey (s. Fig. 102, position 2).

To turn the auto-activation of the night mode on/off, press the hotkey "Edit Value", while "Automatic" is marked (s. Fig. 102, position 1).

Following dialog appears (s. Fig. 103).

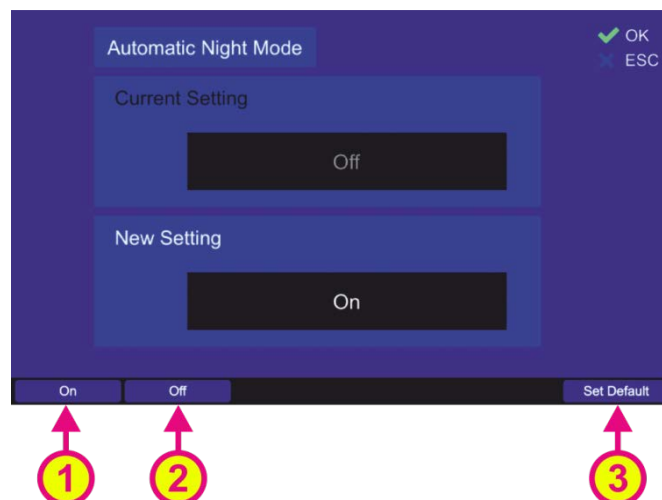

Fig. 103 Turning on/off the automatic activation of night mode

- Press the hotkey “On” (s. Fig. 103, position 1) in order to enable the automatic night mode activation (at the ambient brightness level adjusted in the “Activation Threshold” setting).
- Use the “Off” hotkey to disable the automatic activation of the night mode. In this case, switching between night and day modes is only possible manually in the “Adjust Brightness” dialog (s. 6.5.4).
- Use the “Set Default” hotkey to reset the value to the default value (“Off”).
- Confirm the changed value with “OK” or press “ESC” to leave the dialog without saving the change.

Activation Threshold

This setting can be used to define the ambient brightness level (measured by the light sensor) at which the night mode is triggered, if the “Automatic” activation is enabled (s. previous setting).

The display will change back to “Day” mode automatically after reaching:

ambient brightness value = “Activation Threshold” value [%] + 10 [%] (light sensor hysteresis).

To change the threshold value, press the hotkey “Edit Value”, while “Activation Threshold” is marked.

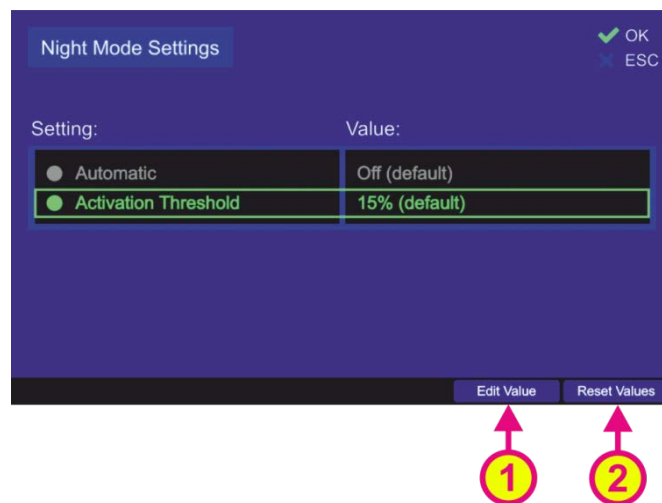

Fig. 104 Selecting the „Activation Threshold“ for editing the value

Following dialog appears (s. Fig. 105).

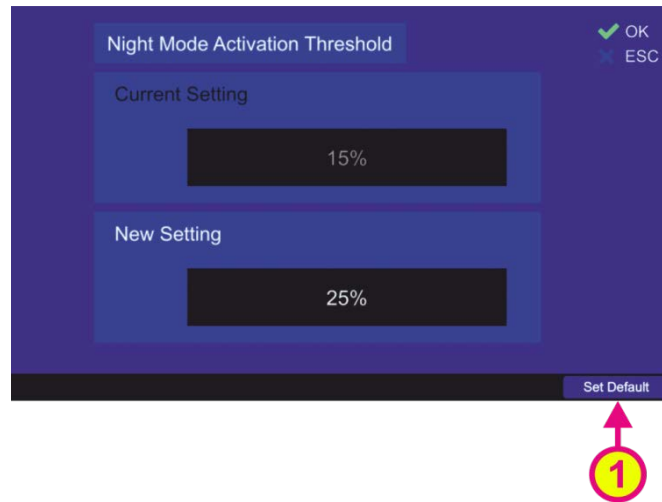

Fig. 105 Changing the value for the night mode activation threshold

- Enter the new value for the night mode activation threshold in the “New Setting” input field, using the numeric buttons of the DCU keypad.
- Use the “Set Default” hotkey (s. Fig. 105, position 2) to reset the value to the default value (15%).
- Confirm the changed value with “OK” or press “ESC” to leave the dialog without changing the current setting.

6.4.3 System

The “System” settings page contains a number of the internal system settings, which are only available over the administrator access level.

All settings are organized alphabetically in order to improve the handling of the page.

Caution

Incorrect system settings may lead to malfunctions of the system.

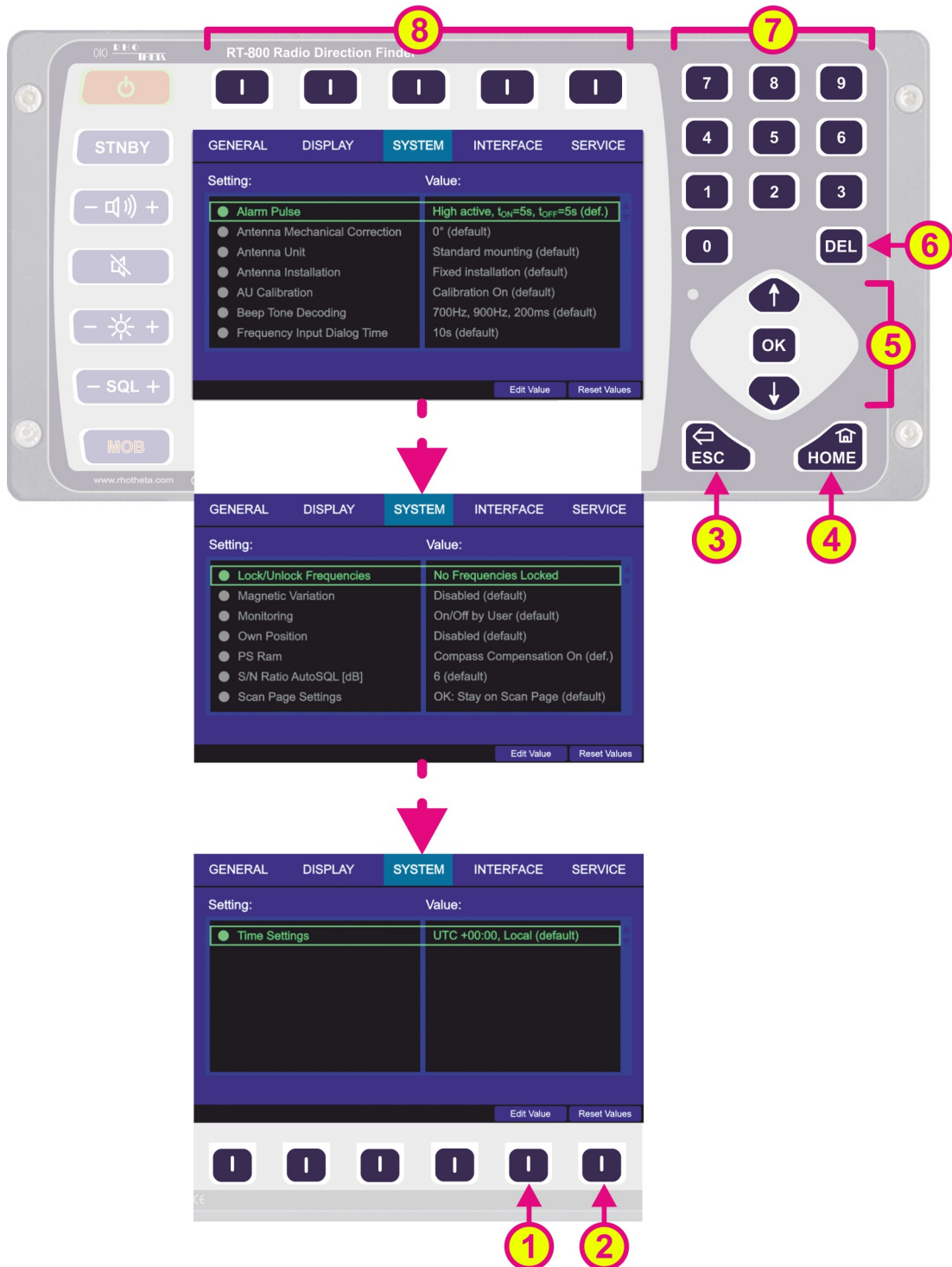

Fig. 106 Setup page. System settings

The “System” settings page contains multiple settings that are represented by textual lines. Keep pressing the “Up” or “Down” arrow buttons of the DCU keypad to switch to the next page with the next settings.





| Indication on Setup Page, Display Settings | | |
|--|---|--|
| Pos. | Element | Meaning / Description |
| 1 | “Edit Value” | Depending on currently marked line, using this hotkey will open the dialog for changing the corresponding value (s. descriptions in the subsequent chapters). |
| 2 | “Reset Values” | Resets all values to the default settings (s. 13.4). The default values themselves cannot be changed by the user (RHOTHETA specification). |
| 3 |  | When there is a dialog opened, pressing this button will close the dialog without adopting new values. When there is no dialog opened, pressing this button will go back to the last activated page. The “Bearing” page is the end point. |
| 4 |  | Pressing this button always leads to the “Bearing” page. Even an opened dialog will be closed, without adopting the changed values. |
| 5 |  | “Up” and “Down” arrows are used to move between the system settings. “Right and “left” arrows have no function inside the system settings” page. With the “OK” button confirming of values or opening the system settings dialogs is accomplished. |
| 6 |  | Inside the dialogs for the system settings, the “DEL” button is used to clear the whole input at once. On the top level of this page, this button has no function. |
| 7 |  | Numeric keys are used to enter the numerical characters inside the dialogs. On the top level of the page they have no function. |
| 8 | Top line | Navigation line of the screen, which allows switching between setup menus (“General”, “Display”, “System”, “Interface” and “Service”). |

Table 14 Setup page, system settings. List of elements

6.4.3.1 Alarm Pulse

With this setting menu, the behavior of the alarm output can be defined. The alarm output is provided by the DCU POWER+IO Connector (s. 7.1) and can be used for related alarm functions like activating a siren.

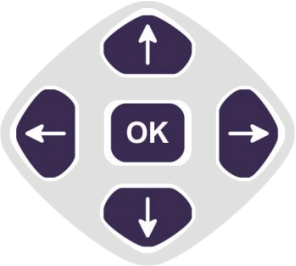
In order to facilitate the alarm function using the DCU (in combination with the alarm system that is used on the vessel), the DCU settings are changeable. By pressing the “OK button or the hotkey “Edit Value”, while the setting “Alarm Pulse” is marked by the green frame, the following dialog is opened.

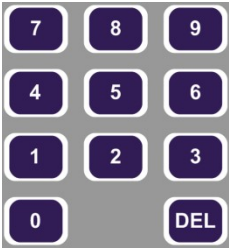
Note

In this dialog pressing “OK” will be interpreted as confirming of the whole set of settings that are currently displayed, which will lead to closing the dialog confirming changed values. To change the single settings only the hotkeys for modifying the related values are used (s. Fig. 107).

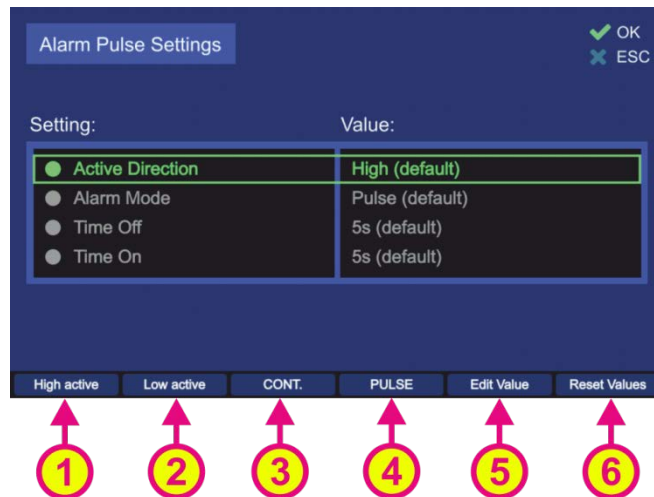

Fig. 107 Alarm pulse settings

Active direction setting defines which direction (low or high) will lead to an alarm indication. This setting is changeable using the hotkeys “High active” / “Low active” or “Edit Value” (s. Fig. 107, numbers 1, 2 and 5), whereat using the first two hotkeys will change the value without opening the separate dialog.

- By pressing the hotkey “Edit Value”, the dialog for changing the active direction of the alarm output will be opened. The handling of this dialog is shown in Fig. 108.

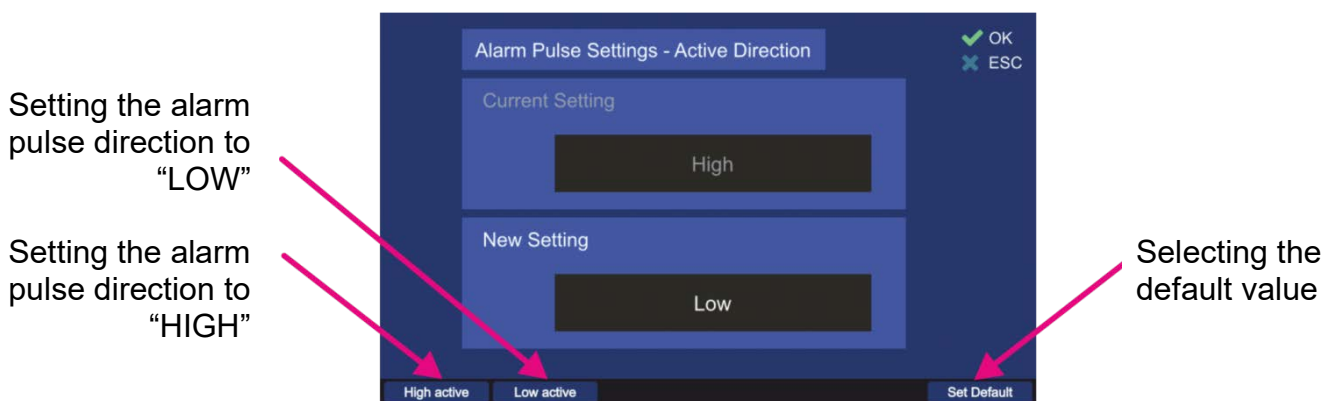

Fig. 108 Active direction dialog

- Pressing the “High active” hotkey sets the active direction of the alarm pulse to “HIGH”. That means, the default state of the alarm output is low and an alarm is indicated by the high state.

- Pressing the "High active" hotkey sets the active direction of the alarm pulse to "LOW". That means, the default state of the alarm output is high and an alarm is indicated by the low state.
- Pressing the "Set Default" hotkey sets the alarm output to the default value, which is "HIGH".

Alarm mode setting defines, how the alarm output behaves during the alarm state (alarm mode continuous or pulsed).

This setting is changeable using the hotkeys "CONT." / "PULSE" or "Edit Value" (s. Fig. 107, numbers 3, 4 and 5), whereat using the first two hotkeys will change the value without opening the separate dialog.

- By pressing the hotkey "Edit Value", the dialog for changing the alarm mode of the alarm output will be opened. The handling of this dialog is shown in Fig. 109.

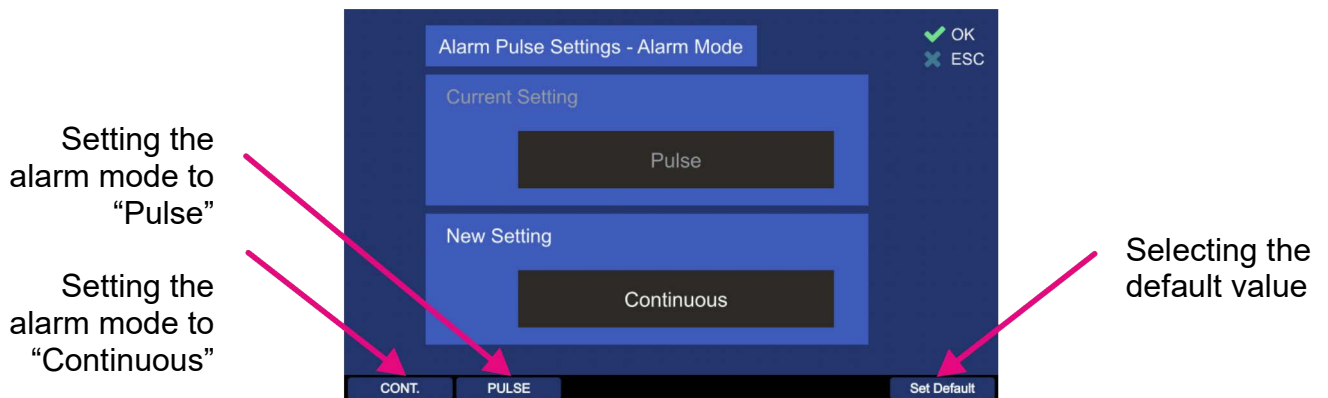

Fig. 109 Alarm mode dialog

- Pressing the "CONT." hotkey sets the alarm mode of the alarm pulse to "Continuous". That means the output is high or low as long as the alarm condition exists.
- Pressing the "PULSE" hotkey sets the alarm mode to "Pulse", which means that the output is pulsed as long as the alarm condition exists. The pulsed signal is defined by the settings "Active Direction", "Time Off" and "Time On".
- Pressing the "Set Default" hotkey sets the alarm output to the default value, which is "Pulse".

Time Off

This setting defines the time of the absence of the alarm indication (the duration of the alarm absence), e.g. using the default value of 5 seconds will stop the alarm indication for 5 seconds after period of the alarm-on time, which is adjusted in the "Time On" setting".

- To change the "Time Off"- time, press the hotkey "Edit Value" (s. Fig. 107, position 5). The related dialog will open (s. Fig. 110).

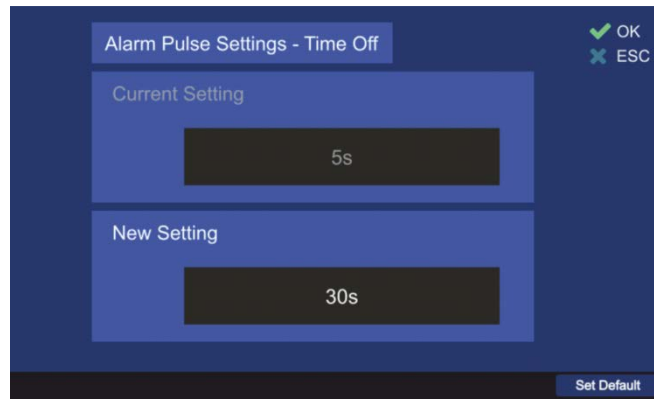

Fig. 110 Time off Dialog

- Use the number keys of the DCU keypad to enter the new value for the “Time Off” setting.
- Press the hotkey “Set Default” to use the default value of 5 s.
- Confirm the setting with “OK” or leave the dialog without adopting the new value by pressing “ESC”.

Time On

This setting defines the time of the alarm indication (the duration of the alarm pulse), e.g., using the default value of 5 seconds will lead to an alarm indication for 5 seconds after the “Time on” was triggered.

- To change the “Time On”- time, press the hotkey “Edit Value” (s. Fig. 107, position 5). The related dialog will open (s. Fig. 111).

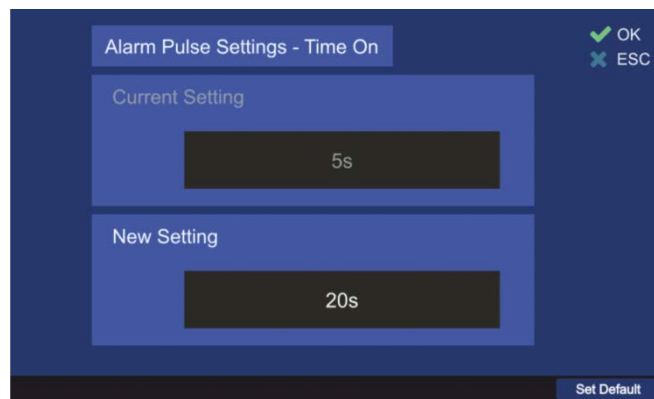

Fig. 111 Time on Dialog

- Use the number keys of the DCU keypad to enter the new value for the “Time On” setting.
- Press the hotkey “Set Default” to use the default value of 5 s.
- Confirm the setting with “OK” or leave the dialog without adopting the new value by pressing “ESC”.

6.4.3.2 Antenna Unit

The RT-800 dipole antenna unit can only be mounted in the vertical position.

For standard mounting (which is the default setting), the mounting flange points to the ground in a fixed installation (bottom of the vessel/vehicle for mobile use).

This setting must be changed to “Upside Down”, if the antenna is mounted hanging upside down (flange on the top), in order to get the correct signal processing.

- By pressing the “OK” button or the hotkey “Edit Value” (s. Fig. 106), while the setting “Antenna Unit” is marked by the green frame, the following dialog is opened.

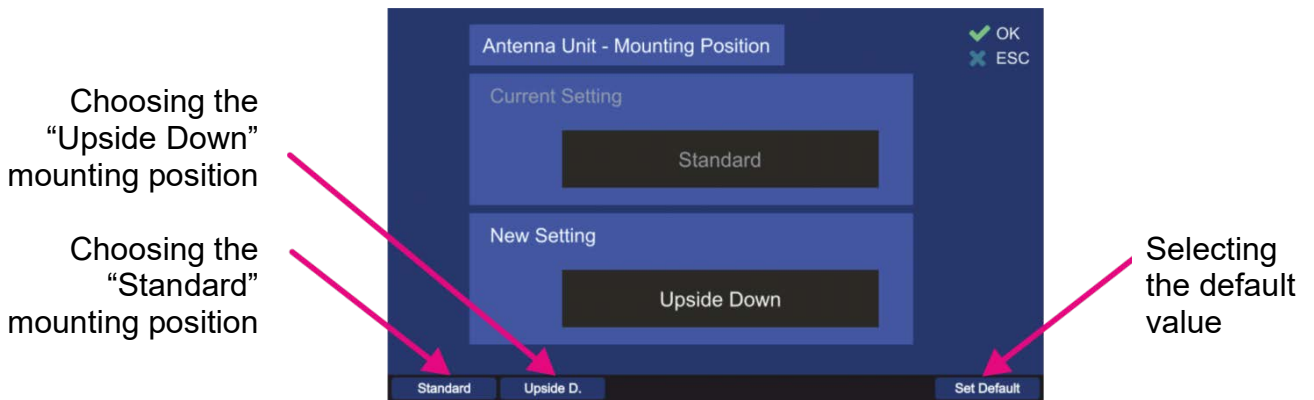

Fig. 112 Antenna unit (mounting position) dialog

- Pressing the “Standard” hotkey sets the value for the mounting position to “Standard”.
- Pressing the “Upside D.” hotkey sets the value for the mounting position to “Upside Down”.
- Pressing the “Set Default” hotkey sets the antenna unit mounting position to the default value, which is “Standard”.
- Confirm the setting with “OK” or leave the dialog without adopting the new value by pressing “ESC”.

6.4.3.3 Antenna Mechanical Correction

The antenna is to be mounted facing "North" or "0°" direction. There is a "North" respectively "0°" marker on the antenna unit, which ideally has to point to the (magnetic/geographic) North in a permanent installation (or to the vessel's bow/vehicle's front, parallel to the vessel's/vehicle's longitudinal axis, in an installation for the mobile use).

If for some reason the antenna cannot be mounted pointing exactly to the North/bow, the mechanical offset correction should be put in, using this setting, in order to calculate bearing values correctly.

The offset is adjustable from 0° to 359° (e.g. -15° = 345°).

- By pressing the “OK” button or the hotkey “Edit Value” (s. Fig. 106), while the setting “Antenna Mechanical Correction” is marked by the green frame, the following dialog is opened.

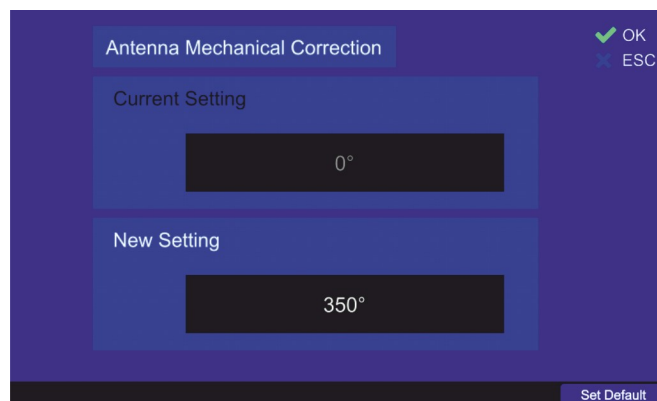

Fig. 113 Antenna mechanical correction dialog

- Use the number keys of the DCU keypad to enter the new value for the “Antenna Mechanical Correction”.
- Press the hotkey “Set Default” to use the default value of 0°.
- Confirm the setting with “OK” or leave the dialog without adopting the new value by pressing “ESC”.

6.4.3.4 Antenna Installation

This setting can be used to determine which type of installation is used for the DF system. RT-800 direction finder system can be used for fixed (permanent) as well as mobile applications.

- By pressing the “OK button or the hotkey “Edit Value” (s. Fig. 106), while the setting “Antenna Installation” is marked by the green frame, the following dialog is opened.

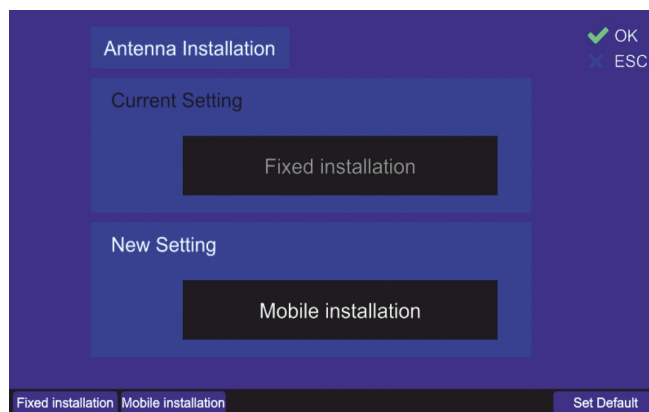

Fig. 114 Antenna installation dialog

- Pressing the hotkeys “Fixed Installation” or “Mobile Installation” sets the corresponding value for the antenna installation into “New Setting” field.
- Pressing the “Set Default” hotkey sets the antenna installation to the default value, which is “Fixed Installation”.
- Confirm the setting with “OK” or leave the dialog without adopting the new value by pressing “ESC”.

6.4.3.5 AU Calibration

This setting determines whether calibration values are used for the bearing calculation or not. In the default case, the internal calibration values of the AU are not used.

- By pressing the “OK button or hotkey “Edit Value” (s. Fig. 106), while the setting “AU Calibration” is marked by the green frame, the following dialog is opened.

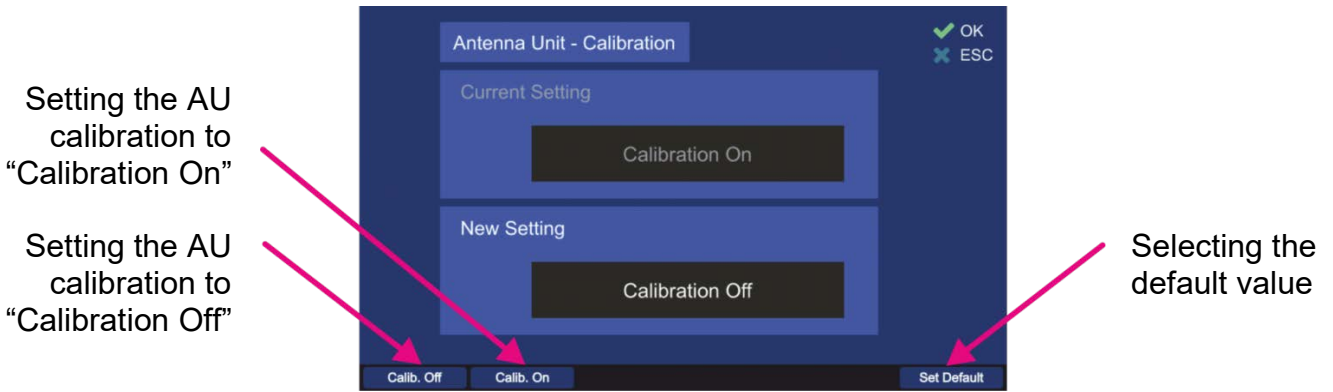

Fig. 115 AU calibration dialog

- Including the AU calibration values into the bearing calculation is done by pressing the hotkey “Calib. On”.
- To disable using the internal calibration values of the AU choose the hotkey “Calib. Off”.
- Press the hotkey “Set Default” to use the default value (“Calibration On”).
- Confirm the setting with “OK” or leave the dialog without adopting the new value by pressing “ESC”.

6.4.3.6 Beep Tone Decoding

Parameters of the menu “Beep Tone Decoding” control the behavior of the function “Fast Channel Scan”, for the case that an alarm should be triggered only if an audio signal (“BeepTone”) has been decoded.

The user can define characteristics of beep tone decoding by pressing “OK” or the hotkey “Edit Value” (s. Fig. 106), while the setting “Beep Tone Decoding” is marked by the green frame. The following dialog opens (s. Fig. 116).



Fig. 116 Beep tone decoding settings

All values can be set to the default values, using the hotkey “Reset Values” (s. Fig. 116, position 5).

Frequency High defines the upper frequency for the beep tone decoding. The default value for this setting is 900 Hz. There are two ways to change this setting: either using the “Freq.

High” or the “Edit Value” hotkey (s. Fig. 116, positions 1 and 4), both of these hotkeys will open the same dialog.

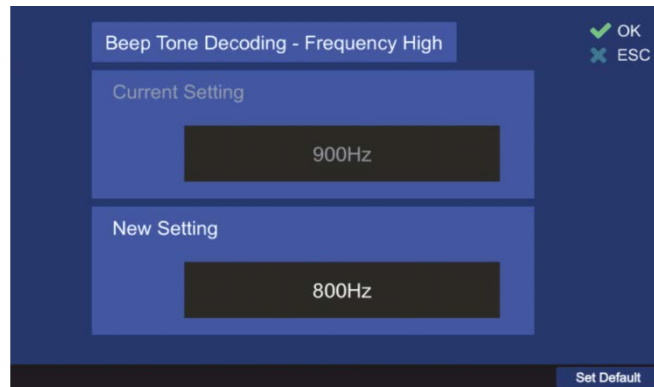

Fig. 117 Dialog for the upper frequency (Beep Tone Decoding)

- Type the new value for the upper frequency into the “New Setting” field, using the DCU number keys.
- Press the hotkey “Set Default” to use the default value (900 Hz).
- Confirm the setting with “OK” or leave the dialog without adopting the new value by pressing “ESC”.

Frequency Low defines the upper frequency for the beep tone decoding. The default value for this setting is 700 Hz. There are two ways to change this setting: either using the “Freq. Low” or the “Edit Value” hotkey (s. Fig. 116, positions 2 and 4), both of these hotkeys will open the same dialog.

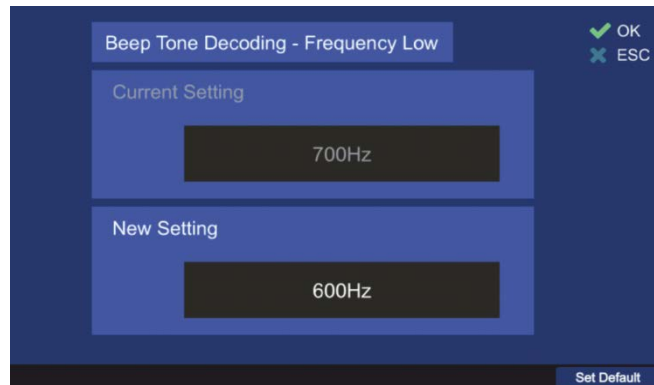

Fig. 118 Dialog for the lower frequency (Beep Tone Decoding)

- Type the new value for the lower frequency into the “New Setting” field, using the DCU number keys.
- Press the hotkey “Set Default” to use the default value (700 Hz).
- Confirm the setting with “OK” or leave the dialog without adopting the new value by pressing “ESC”.

Decoding Time defines the decoding time for the beep tone decoding (minimum required duration of the signal).

The default value for this setting is 200 ms. There are two ways to change this setting: either using the “Dec. Time” or the “Edit Value” hotkey (s. Fig. 116, positions 3 and 4), both of these hotkeys will open the same dialog.

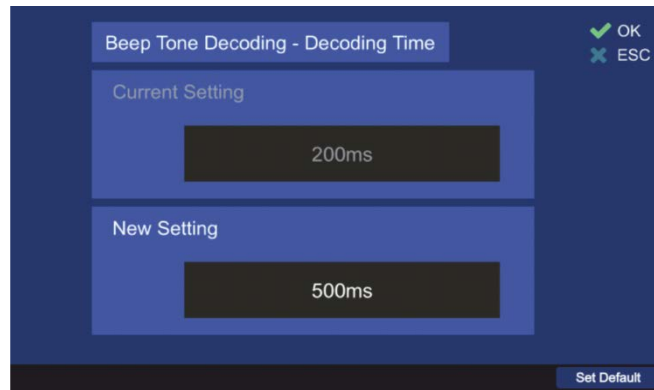

Fig. 119 Decoding time dialog

- Type the new value for the decoding time into the “New Setting” field, using the DCU number keys.
- Press the hotkey “Set Default” to use the default value (200 ms).
- Confirm the setting with “OK” or leave the dialog without adopting the new value by pressing “ESC”.

6.4.3.7 Frequency Input Dialog Time

This setting defines the duration until the dialog for frequency input (s. 6.1.2.2) closes automatically if no interaction of the user happens.

- By pressing the “OK button or hotkey “Edit Value”, while the setting “Frequency Input Dialog Time” is marked by the green frame, the following dialog is opened.

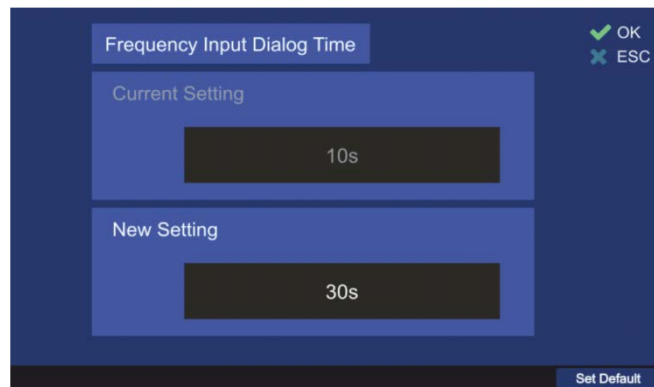

Fig. 120 Frequency input hold time dialog

- Type the new value for the frequency input hold time into the “New Setting” field, using the DCU number keys.
- Press the hotkey “Set Default” to use the default value (10 s).
- Confirm the setting with “OK” or leave the dialog without adopting the new value by pressing “ESC”.

6.4.3.8 Lock/Unlock Frequencies

It is possible to lock or unlock particular frequencies as well as entire frequency bands from the licensed frequency ranges. After a frequency has been locked, it will not be possible to set this frequency for the bearing operation on the “Bearing” page.

Locking/unlocking of frequencies is the responsibility of the administrator. The operator can only view the frequencies, which have been locked by the administrator in the dialog “Frequency Information Dialog” (s. 6.4.1.8).

- By pressing the “OK button or hotkey “Edit Value” (s. Fig. 106), while the setting “Lock/Unlock Frequencies” is marked by the green frame, the following dialog is opened (s. Fig. 121).
This view will contain only one hotkey “Add Freq.” if entered for the first time, when no frequency is locked yet.

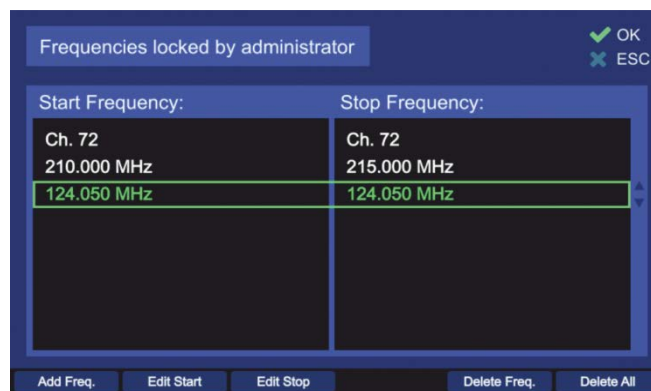

Fig. 121 Locked frequencies list. Administrator view

- The use of this dialog is described in chapter 6.4.1.8, please refer to it for more information.

6.4.3.9 Magnetic Variation

This setting allows the entering of the magnetic variation angle if it is known for the current location.

Depending on what type of compass is connected to the direction finder, the magnetic variation is used (or not) for the calculation of the true or magnetic bearing.

Note

If GPS is connected, the magnetic variation value from the GPS data is used (the manually entered value of magnetic variation is ignored).

Note

The magnetic variation angle varies depending on the position on the Earth’s surface. For larger changes in distance, the value entered here should be reviewed and corrected if necessary.

- By pressing the “OK button or “Edit Value” hotkey (s. Fig. 106), while the setting “Magnetic Variation” is marked, the following dialog is opened.

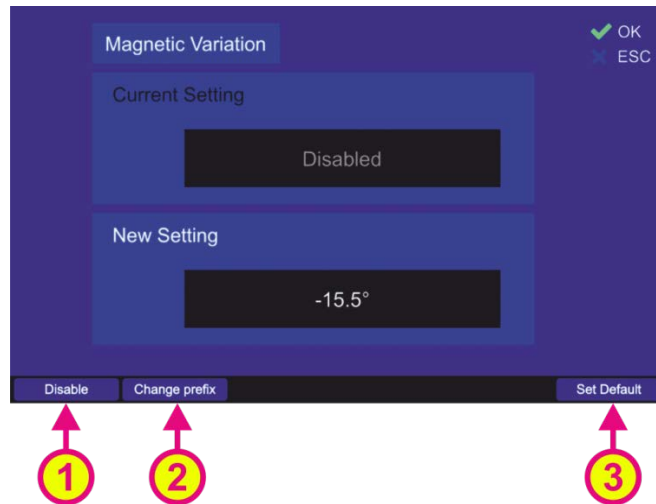

Fig. 122 Input of the magnetic variation value

- Type the new value into the “New Setting” field, using the DCU number keys. The entry format is a value with one position after decimal point. For entering e.g. “5.5°” press the key “5” twice, the decimal point and the degrees sign is set automatically.
- Pressing the “Disable” hotkey (s. Fig. 122, position 1) deactivates using of the magnetic variation and deletes its current value.
- To change the sign of the degree value, press the “Change prefix” hotkey (s. Fig. 122, position 2).
- Press the hotkey “Set Default” (s. Fig. 122, position 3) to use the default value (“Disabled”).
- Confirm the setting with “OK” or leave the dialog without adopting the new value by pressing “ESC”.

6.4.3.10 Monitoring

This setting determines how the “Monitoring” function will be handled.

There are two possible settings in this menu (s. Fig. 123).

- To open the dialog for the “Monitoring” handling, press button “OK” or hotkey “Edit Value”, while the line “Monitoring” is marked.

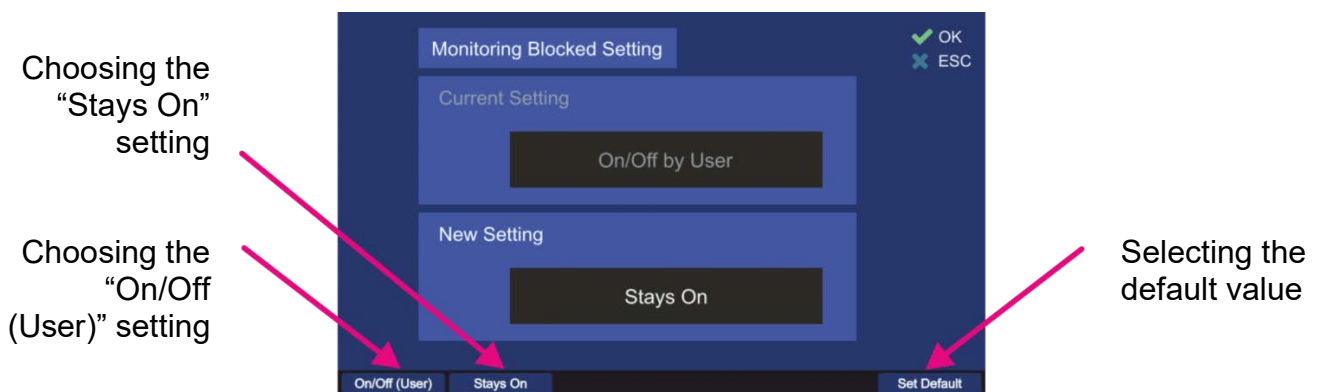

Fig. 123 Monitoring handling settings

- Choose the new setting using one of the hotkeys (s. Fig. 123), which will then appear in the “New Setting” field.
“On/Off (User)” The user can start and terminate the monitoring mode.

“Stays On” The monitoring mode starts immediately after adopting this setting and the user cannot terminate this mode. To terminate the monitoring mode or change this setting the “Administrator” access is needed.

- Press the hotkey “Set Default” to use the default value (“On/Off by User”).
- Confirm the setting with “OK” or leave the dialog without adopting the new value by pressing “ESC”.

6.4.3.11 Own Position

For the fixed (permanent) installation of the RT-800 system, it is possible to enter the GPS coordinates of the location (own position). Entry in two formats is possible (DMS and DD). This setting has no default value, respectively it is set to “Disabled”.

Note

If valid GPS data from external GPS device is available, it is used instead of the value entered here (GPS device data has priority).

- To open the own position dialog, press button “OK” or hotkey “Edit Value”, while the line “Own Position” is marked (s. Fig. 106).

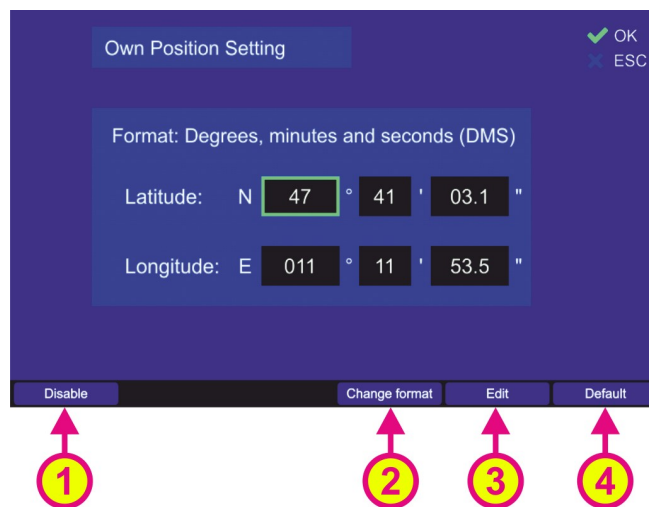

Fig. 124 Own GPS position dialog

- Choose the input format of the GPS coordinates by pressing the hotkey “Change format” (s. Fig. 124, position 2). It is possible to enter the own GPS position in DMS (degrees, minutes, and seconds) or in DD (decimal degrees) format.

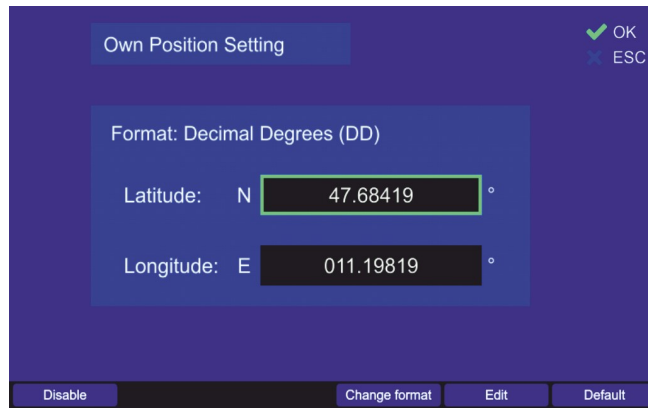

Fig. 125 Own position in DD format

- Press the hotkey “Edit” (s. Fig. 124, position 3) to start entering/changing the GPS coordinates by using the number keys and arrow buttons of the DCU. The decimal point is set automatically.
- Pressing the “Disable” hotkey (s. Fig. 124, position 1) deactivates using of the own GPS position and deletes its current value.
- Press the hotkey “Default” (s. Fig. 124, position 4) to use the default value (“Disabled” / no own position).
- It is also possible to choose between the N/S latitude and W/E longitude input by pressing the corresponding hotkeys while editing the coordinates (s. “N/S Latitude” and “W/E Longitude” in Fig. 126).

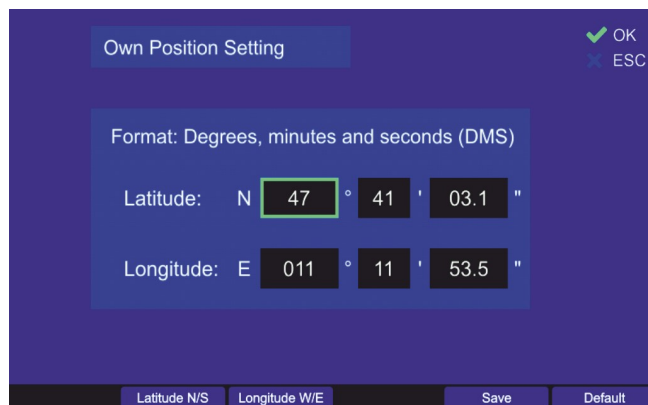

Fig. 126 Editing the own GPS coordinates

- Press the hotkey “Save” (s. Fig. 126) to save the entered values.
- Confirm the setting with “OK” or leave the dialog without adopting the new value by pressing “ESC”.

6.4.3.12 PS Ram

This setting defines whether the compass data should be used to compensate the “Contouring Error” inside the AU.

This setting is relevant for the mobile installation of RT-800 DF system (on a vessel or vehicle).

Fast changes of the vessel’s course can lead to a “Contouring Error” of the bearing indication, which manifests in quite slow changing of the direction on the bearing page compared to the vessel’s direction change. The reason is the averaging procedure of the phase summator inside the antenna unit.

If an external compass is connected, the bearing value determination can be done by a special, improved compensating procedure (the “PS Ram compensation”), which eliminates the contouring error. For a compass of minor quality (e.g., heavy and quick variations) it may be necessary, to switch off the “PS Ram compensation”.

- To open the dialog for the “PS Ram” handling, press button “OK” or hotkey “Edit Value”, while the line “PS Ram” is marked.

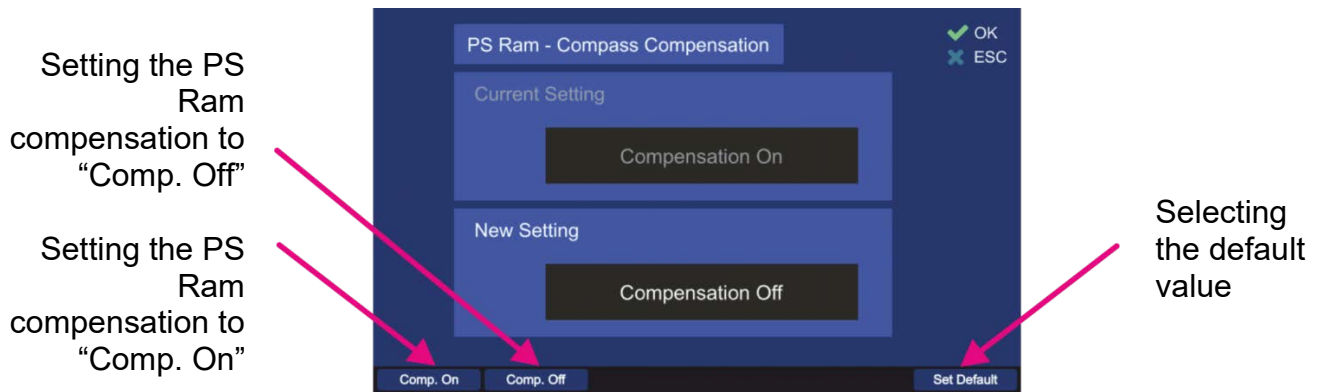

Fig. 127 PS Ram compensation dialog

- Choose the new setting using one of the hotkeys (s. Fig. 127), which will then appear in the “New Setting” field.
 - “**Comp. On**”: The AU will use compass values to compensate the contouring error.
 - “**Comp. Off**”: The AU will not use compass values to compensate the contouring error.
- Press the hotkey “Set Default” to use the default value (“Comp. On”).
- Confirm the setting with “OK” or leave the dialog without adopting the new value by pressing “ESC”.

6.4.3.13 S/N Ratio AutoSQL [dB]

This value defines the “Signal to Noise Ratio” for the automatic squelch control inside the AU. S/N Ratio determines how many level-points the squelch marker is set above the noise level. If e.g. the value is 6, the squelch marker is always adjusted 6 level-points above the noise level, when the “AutoSQL” function is used.

- By pressing the “OK” button or hotkey “Edit Value” (s. Fig. 106), while the setting “S/N Ratio AutoSQL [dB]” is marked, the following dialog is opened (s. Fig. 128).

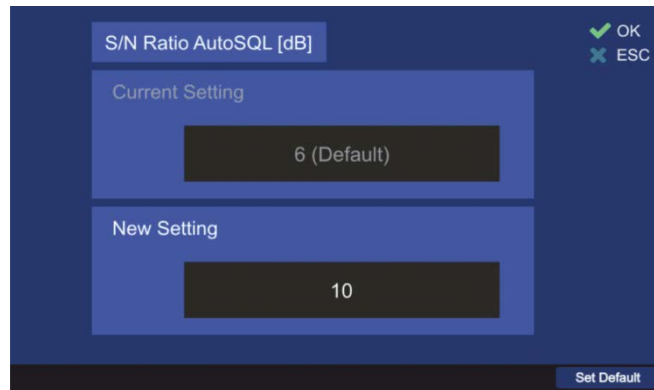

Fig. 128 S/N Ratio for auto squelch function

- Use the number keys of the DCU keypad to enter the new value for the “S/N Ratio”.
- Press the hotkey “Set Default” to use the default value of “6”.
- Confirm the setting with “OK” or leave the dialog without adopting the new value by pressing “ESC”.

6.4.3.14 Scan Page Settings

This value defines the effect of pressing “OK” on the “Scan” page.

In every case, pressing “OK” will start a scan algorithm, if it was in a deactivated state, but with one setting the “Scan” page will stay open, and in the other case the “Bearing” page will be opened.

- By pressing the “OK button or hotkey “Edit Value” (s. Fig. 106), while the setting “Scan Page Settings” is marked, the following dialog is opened (s. Fig. 129).

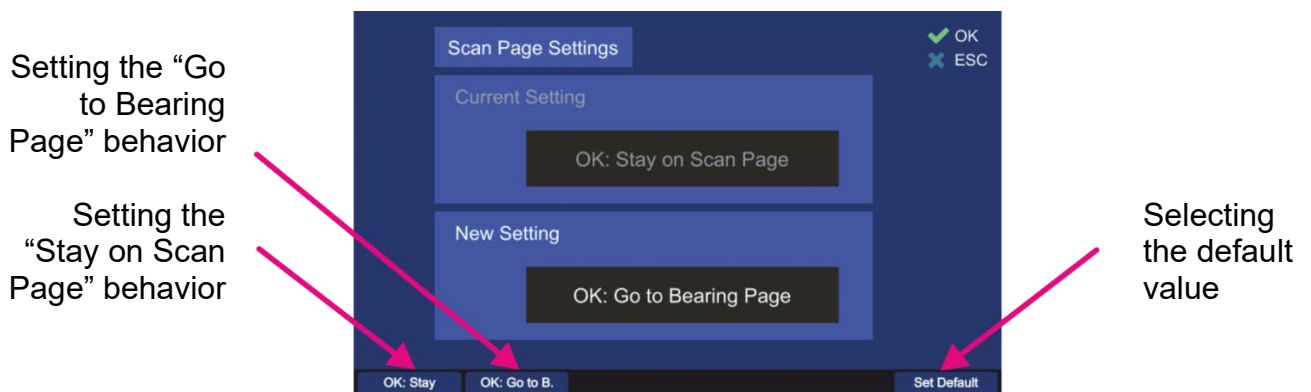

Fig. 129 Scan page settings dialog

- Choose the new setting using one of the hotkeys (s. Fig. 129), which will then appear in the “New Setting” field.
 - “**OK: Stay**” : Pressing this hotkey defines that the “Scan” page should stay opened after starting a scan algorithm by pressing “OK” (on the “Scan” page).
 - “**OK: Go to B.**” : Pressing this hotkey defines that the “Bearing” page should be opened after starting a scan algorithm by pressing “OK” (on the “Scan” page).
- Press the hotkey “Set Default” to use the default value (“OK: Stay on Scan Page”).
- Confirm the setting with “OK” or leave the dialog without adopting the new value by pressing “ESC”.

6.4.3.15 Time Settings

This setting allows to select between the local and UTC time for operating the DF-system. Any time-related indication in the DCU will be shown depending on this setting.

Note

To keep track of time when the device is turned off, a real time clock powered by battery cell (CR2032 Lithium Cell 3V (solid soldered)) is built in the DCU. Discharging of the battery will result in losing track of time. Battery replacement every 10 years is recommended. The exchange of the Lithium battery cell should be performed only by RHOTHETA Elektronik GmbH or an authorized maintenance facility.

To change this setting press the hotkey "Edit Value" while the "Time Settings" line is marked (s. Fig. 130, position 1).

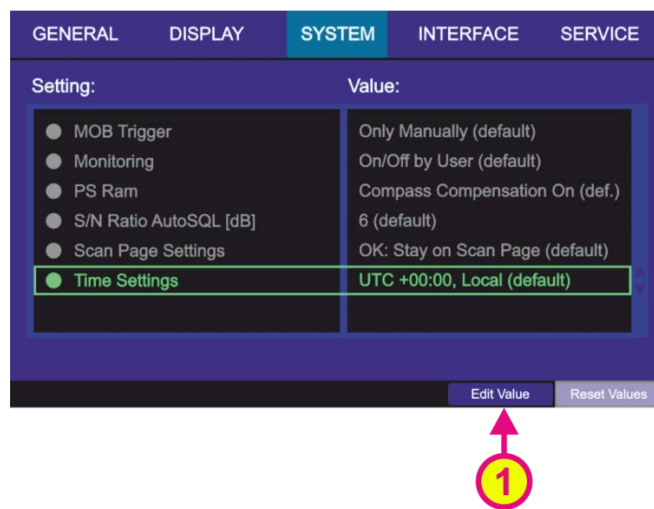

Fig. 130 Selecting the time settings

The following dialog appears (s. Fig. 131).

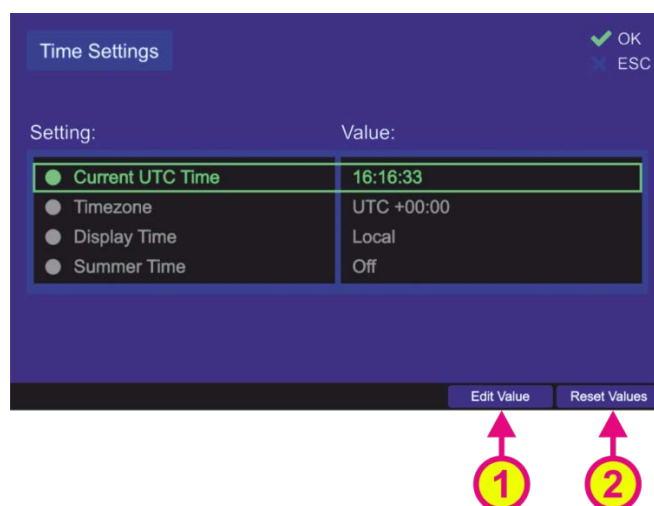

Fig. 131 Time settings dialog

Note

If you press "OK" in this view, the current settings will be interpreted as the ones to be saved, which will cause the dialog to close again, saving these values. In order to change the single settings always use the "Edit Value" hotkey.

To set the time settings to default, press the “Reset Values” hotkey (s. Fig. 131, position 2).

Current UTC Time

This setting allows to adjust the UTC time value.

To change the UTC time value, press the hotkey “Edit Value”, while “Current UTC Time” is marked (s. Fig. 131, position 1).

Following dialog appears (s. Fig. 132).

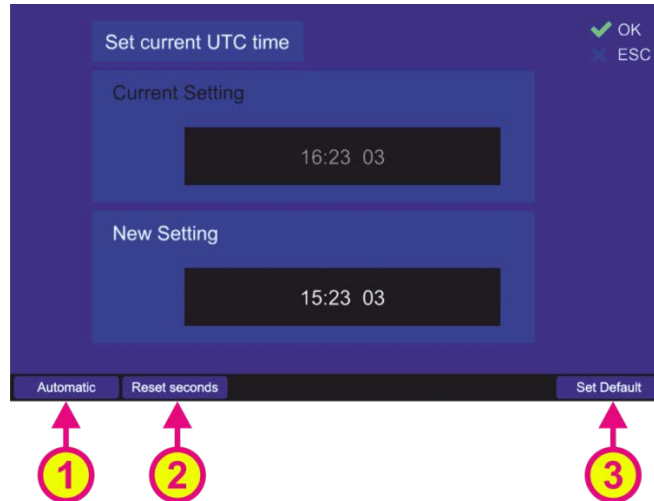

Fig. 132 Changing the UTC time

- Enter the new value for the UTC time in the “New Setting” input field, using the numeric buttons of the DCU keypad (“hh:mm”).
- Use the “Automatic” hotkey (s. Fig. 132, position 1) to adopt the GPS time value (only if GPS data is available).
- By default the current seconds value is inherited to the new setting. To reset the seconds value to “00”, press the “Reset seconds” hotkey (s. Fig. 132, position 2).
- Use the “Set Default” hotkey (s. Fig. 132, position 3) to reset the value to the default value (internal time of the DCU real time clock).

Note

The default time setting can differ from the actual UTC time.

- Confirm the changed value with “OK” or press “ESC” to leave the dialog without changing the current setting.

Timezone

With this setting the time zone of the local time can be selected.

To change the time zone value, press the hotkey “Edit Value”, while “Timezone” is marked (s. Fig. 133, position 1).

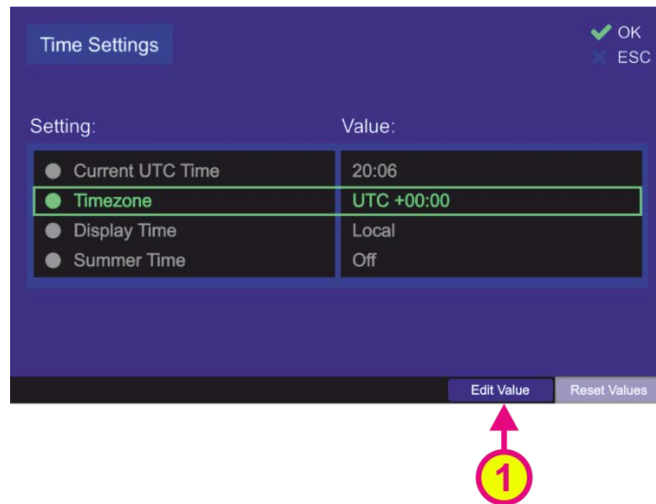

Fig. 133 Selecting time zone setting

Following dialog appears.



Fig. 134 "Select Timezone" dialog

- Choose the proper time difference (local time) to the UTC time using the drop down dialog (s. Fig. 134).
- Use the “Reset Values” hotkey to reset the value to the default value (UTC +00:00).
- Confirm the changed value with “OK” or press “ESC” to leave the dialog without changing the current setting.

Display Time

With this setting it is possible to select whether the “UTC” or “Local” time should be used to display all time related indications in the DCU.

To change the display time value, press the hotkey “Edit Value”, while “Display Time” is marked (s. Fig. 135, position 1).

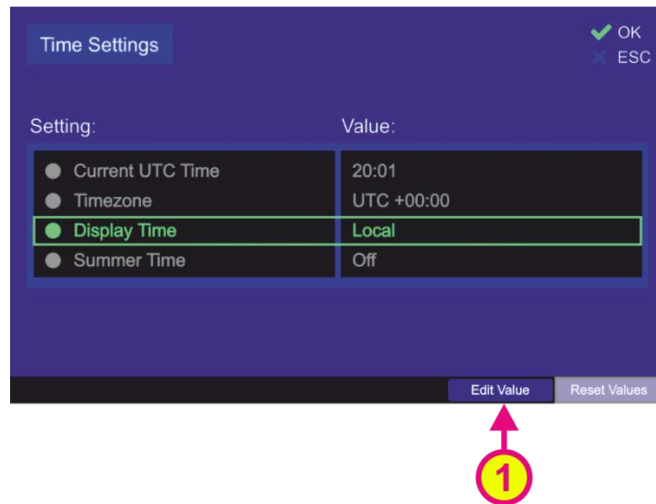

Fig. 135 Selecting the "Display Time" setting

Following dialog appears.

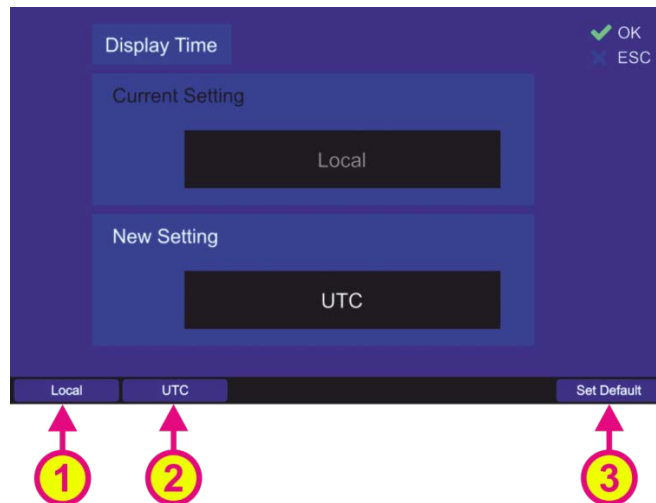

Fig. 136 Changing the "Display Time" setting

- Choose the "Local" or "UTC" hotkey to set the desired variant of the time indication (s. Fig. 136, positions 1 or 2).
- Use the "Set Default" hotkey (s. Fig. 136, position 3) to reset the value to the default value (Local).
- Confirm the changed value with "OK" or press "ESC" to leave the dialog without changing the current setting.

Summer Time

With this setting it is possible to select whether the summer time should be used to display all time related indications in the DCU.

Summer time means a time shift of +01:00 and is relevant for countries or parts of countries that are participating in daylight saving time.

To change the summer time value, press the hotkey "Edit Value", while "Summer Time" is marked (s. Fig. 137, position 1).

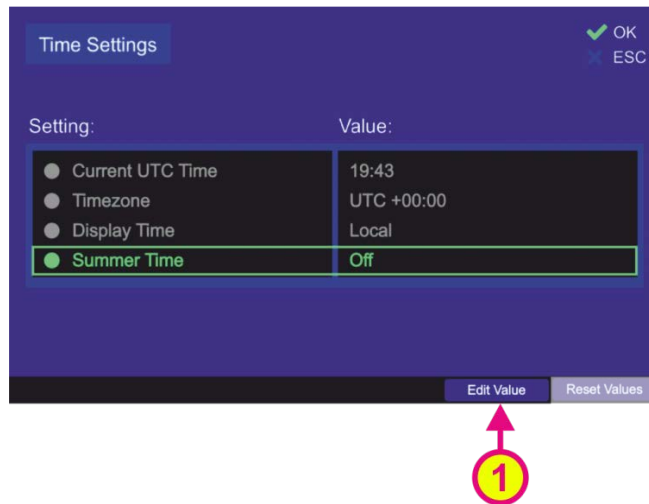

Fig. 137 Selecting summer time setting

Following dialog appears.

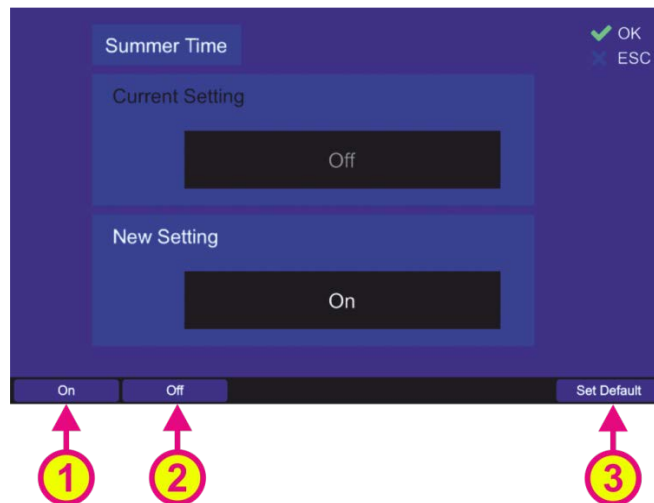

Fig. 138 Changing summer time setting

- Choose the “On” or “Off” hotkey to set the desired variant of the time indication (s. Fig. 138, positions 1 or 2).
- Use the “Set Default” hotkey (s. Fig. 138, position 3) to reset the value to the default value (Off).
- Confirm the changed value with “OK” or press “ESC” to leave the dialog without changing the current setting.

6.4.4 Interface

The setup menu “Interface” contains critical settings that influence important system parameters, therefore it is password protected and can be used by the administrator only.

This page enables the user to configure the interfaces to external devices.

It is possible to configure programmable IOs, LAN interface, interfaces to external compass and GPS. Furthermore, the user is able to configure the characteristics for remote control via NMEA commands.

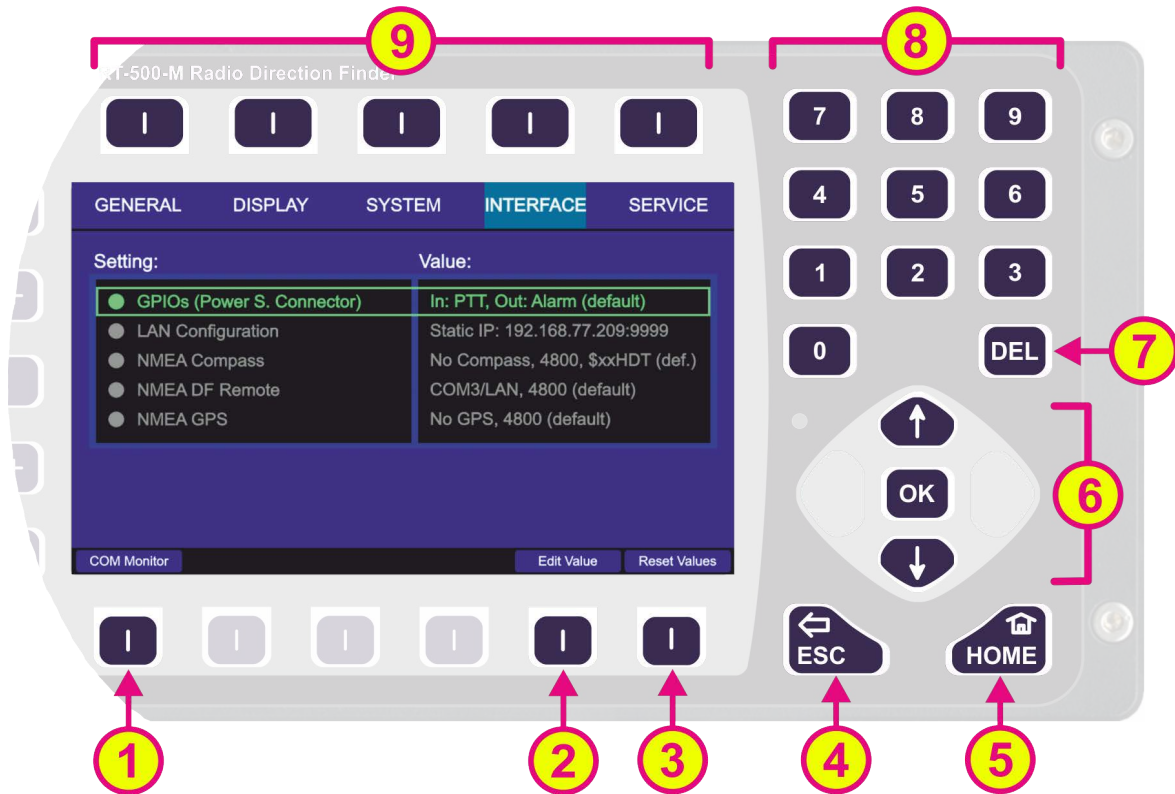

Fig. 139 Setup page. Interface settings

Indication on Setup Page, Interface Settings

| Pos. | Element | Meaning / Description |
|------|----------------|---|
| 1 | “COM Monitor” | Using this hotkey opens the dialog for monitoring the data that is currently being sent out or received via connected NMEA communication ports (s. 6.4.4.1). Only the data exchange that is currently happening is shown there, i.e., if the dialog is closed and opened again, the previously shown data is lost. |
| 2 | “Edit Value” | Depending on currently marked line, using this hotkey will open the dialog for changing the corresponding value (s. descriptions below). |
| 3 | “Reset Values” | Resets all values to the default settings (s. 13.4). The default values themselves cannot be changed by the user (RHOTHETA specification). |





| | | |
|---|--|---|
| 4 |  | When there is a dialog opened, pressing this button will close the dialog without adopting new values. When there is no dialog opened, pressing this button will go back to the last activated page. The “Bearing” page is the endpoint. |
| 5 |  | Pressing this button always leads to the Bearing Page. Even an opened dialog will be closed, without adopting the changed values. |
| 6 |  | “Up” and “Down” arrows are used to move between the display settings. “Right and “left” arrows have no function inside the interface settings” page. With the “OK” button confirming of values or opening the interface settings dialogs is accomplished. |
| 7 |  | Inside the interface settings dialogs the “DEL” button is used to clear the whole input at once. On the top level of this page this button has no function. |
| 8 |  | Numeric keys are used to enter the numerical characters inside the dialogs. On the top level of the page they have no function. |
| 9 | Top line | Navigation line of the screen, which allows switching between setup menus (“General”, ”Display”, “System”, “Interface” and “Service”). |

Table 15 Setup page, interface settings. List of elements

6.4.4.1 COM Monitor

The data exchange at the currently connected NMEA communication ports is visualized in this dialog.

Only the data exchange that is currently happening is shown (corresponding communication ports must be connected correctly), i.e., if the dialog is closed and opened again, the previously shown data is lost.

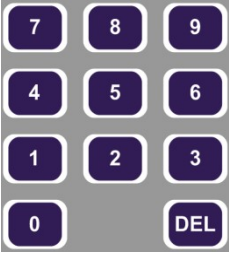
Note

No settings can be made via this dialog. It is for information only.

- To open the dialog for COM monitoring press the “COM Monitor” hotkey (Fig. 139, position 1). Following dialog opens (s. Fig. 140).

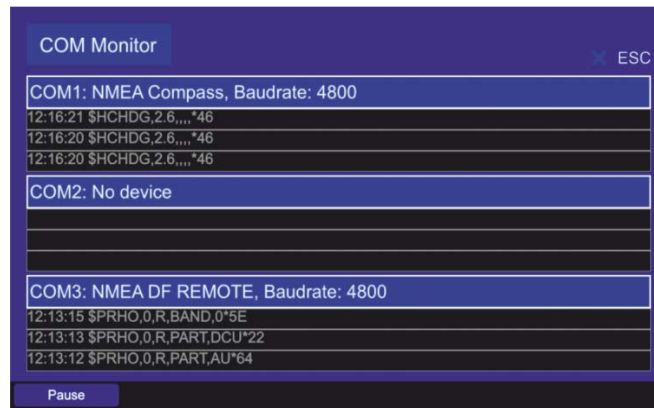

Fig. 140 COM monitoring dialog

- The data is shown in real time, i.e. it is changing if the data is constantly changing. In order to freeze the display, press the “Pause” hotkey.
- To close the dialog press the “ESC” button.

6.4.4.2 NMEA DF Remote

It is possible to operate the RT-800 direction finder remotely using the NMEA communication protocol. For this purpose, a control unit (e.g., ECDIS) can be connected to the NMEA interface of the DCU.

Additionally, by choosing the combination “COM3/ LAN”, the NMEA sentences will be also sent via the LAN connection (s. Fig. 141, position 3).

Caution

If communication ports, other than the default port (COM3), are not used, they will appear as hotkeys in the dialogs (as possible ports to use for the NMEA remote communication). Nevertheless, the communication port COM3 is internally connected to MOXA for remote control purposes.

Please do not:

- adjust other COM-ports for remote control.
- use COM3 for purposes other than remote control.
- disconnect MOXA, if MOXA is used for remote control.

Note

By default, the “Autotalk” mode is activated, which means that NMEA sentences of the direction finder are sent out cyclically with a fixed time period of 250 ms. The “Autotalk” mode can also be deactivated per corresponding NMEA command (s. NMEA-Protocol Description RT-800).

Configure the interface settings for remote control of the direction finder in this menu item.

- Press the button “OK” or hotkey “Edit Value”, while the setting “NMEA DF Remote” is marked (s. Fig. 139).
Following sub-menu will appear (s. Fig. 141).

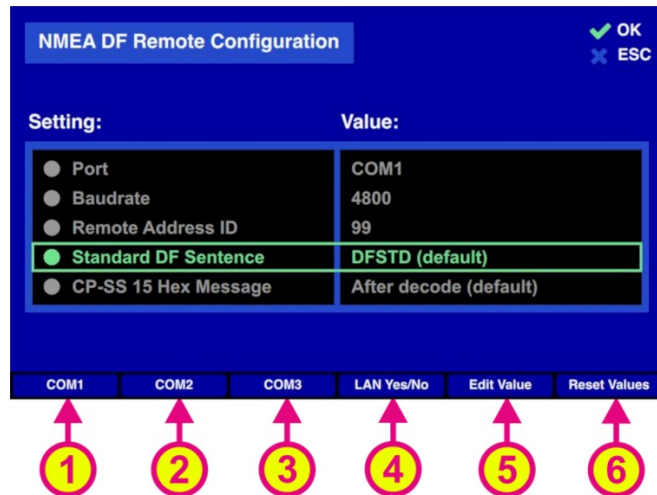

Fig. 141 NMEA DF remote control configuration

The NMEA DF remote configuration is accomplished by the following settings:

- Port
- Baudrate
- Remote Address ID
- Standard DF Sentence
- CP-SS 15 Hex Message

Pressing the hotkey “Reset Values” (s. Fig. 141, position 6) will set all menu items to default values.

To exit the dialog confirming all changes that have been made within the sub-dialogs for single settings, press “OK”.

Note

Pressing “ESC” instead of “OK” when leaving the “NMEA DF Remote Configuration” dialog will discard all entered settings.

Port

This setting defines, which communication port is connected to the remote control PC.

Caution

If communication ports other than the default port (COM3) are not used, they will appear as hotkeys in the dialogs (as possible ports to use for the NMEA remote communication). Nevertheless, the communication port COM3 is internally connected to MOXA for remote control purposes.

Please do not:

- adjust other COM-ports for remote control.
- use COM3 for purposes other than remote control.
- disconnect MOXA, if MOXA is used for remote control.

- Pressing the hotkey “LAN Yes/No” (s. Fig. 141, position 4) will turn on the additional communication over LAN (pressing this hotkey again will turn the LAN communication off, see also 6.4.4.3).

If COMx and LAN are set for remote control, the priority between both is time-based.

Example:

→ Command for squelch comes via LAN.

- Command for squelch comes via COM.
 - ← First, the squelch level gets adjusted on the LAN command. During this time the message from the COM port is buffered.
 - ← After that, the squelch level gets adjusted on the command from COM port.
- Pressing the hotkey “Edit Value” while “Port” is marked (s. Fig. 141), opens the following sub-dialog (s. Fig. 142).

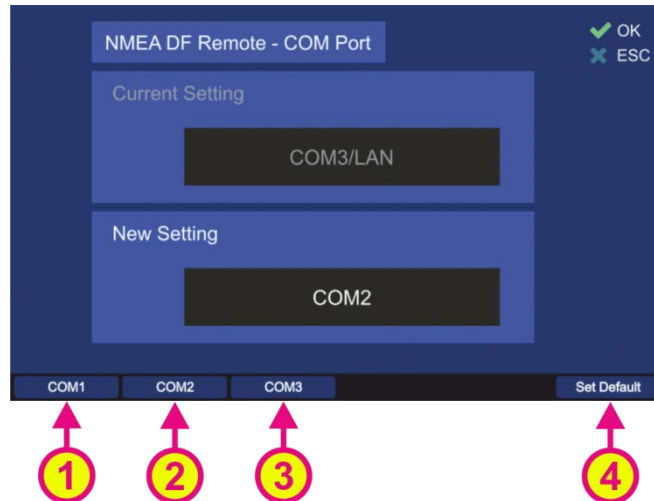

Fig. 142 Remote communication port configuration

- Selecting “COMx” (s. Fig. 142, positions 1, 2 and 3) configures the corresponding NMEA interface as the remote communication port.

Caution

If communication ports other than the default port (COM3) are not used, they will appear as hotkeys in the dialogs (as possible ports to use for the NMEA remote communication). Nevertheless, the communication port COM3 is internally connected to MOXA for remote control purposes.

Please do not:

- adjust other COM-ports for remote control.
- use COM3 for purposes other than remote control.
- disconnect MOXA, if MOXA is used for remote control.

Note

This setting will only set the communication port. Additional transmitting the NMEA sentences over LAN should be set in the top level menu (s. Fig. 141, position 4).

- Press the hotkey “Set Default” to use the default value (COM3/LAN).
- Confirm the setting with “OK” or leave the dialog without adopting the new value by pressing “ESC”.

Baudrate

Defines the speed of NMEA interface data transfer.

The default value for the baud rate of the NMEA remote control is 4800. The baud rate can be changed using this menu item.

For further information please see the document “NMEA Protocol Description RT-800”.

- To change the baud rate, press the hotkey “Edit Value” while the menu item “Baudrate” is marked (s. Fig. 141). The corresponding sub-dialog will be opened (s. Fig. 143).

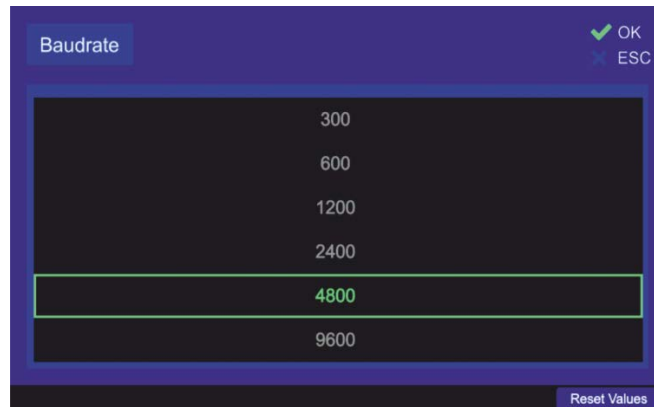

Fig. 143 Remote control baud rate configuration

- Choose the new baud rate value in the drop-down menu.
- Press the hotkey “Reset Values” to use the default value of “4800”.
- Confirm the setting with “OK” or leave the dialog without adopting the new value by pressing “ESC”.

Remote Address ID

It is a setting, which is used to give the direction finder an address ID for the NMEA communication.

The DF only reacts to the NMEA request sentences, if the address ID in the sentence is equal to the address, which is selected via this setting (or has the value 255, if the ID was not set). For further explanation please refer to the document “NMEA-Protocol Description RT-800”.

Note

When using address ID = 255, then all connected DF systems are addressed, independent of their internal IDs.

The address ID can take values between 0 and 99.

- To change this Setting, press the hotkey “Edit Value” while the menu item “Remote Address ID” is marked (s. Fig. 141). The corresponding sub-dialog will be opened (s. Fig. 143).

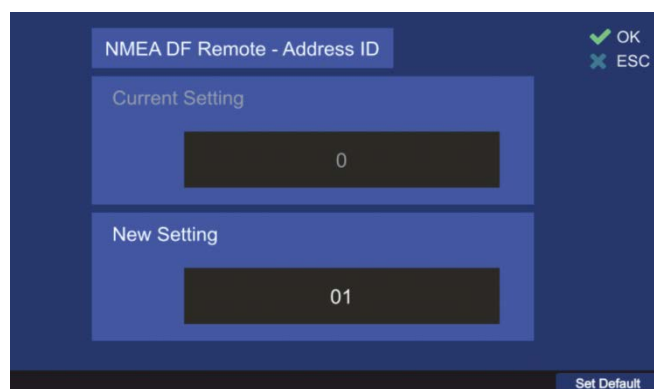

Fig. 144 Remote control address ID configuration

- Use the number keys of the DCU keypad to enter the new value for the “Address ID”.
- Press the hotkey “Set Default” to use the default value of “0”.

- Confirm the setting with “OK” or leave the dialog without adopting the new value by pressing “ESC”.

Standard DF Sentence

Defines the NMEA output sentence of the direction finder.

The default DF output sentence of the NMEA interface is DFSTD. The standard DF output sentence can be changed using this menu item to DFVTS or DFBRG.

For further information please see the document “NMEA-Protocol Description RT-800”.

CP-SS 15 Hex Message

This setting defines, when the COSPAS-SARSAT 15 hex message will be sent over the NMEA interface.

The standard setting is after decoding, which means that the CP-SS 15 hex message will be sent over the NMEA bus immediately after receiving and decoding the COSPAS-SARSAT message. The "After decoding" setting can be changed to an "On NMEA Request" setting using this menu item.

The “On NMEA Request” setting implies that the COSPAS-SARSAT message, after being received and decoded by the direction finder, must be requested with a special command through the NMEA interface.

For additional details regarding the COSPAS-SARSAT data sentence, please refer to the document titled “NMEA-Protocol Description RT-800”.

6.4.4.3 LAN Configuration

The RT-800 DCU can be connected to the Local Area Network as well as the netmask and gateway for remote control can be configured.

To perform the network configuration of the DCU use the menu item “LAN Configuration”.

- Press the button “OK” or hotkey “Edit Value”, while the setting “LAN Configuration” is marked (s. Fig. 139).
Following sub-menu will appear (s. Fig. 145).

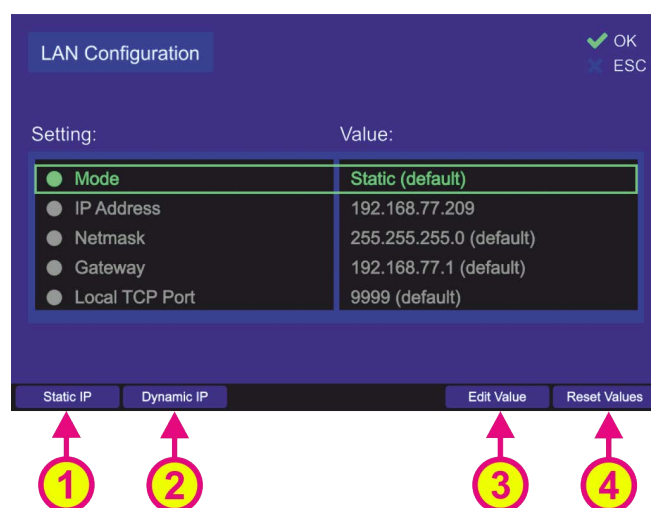

Fig. 145 LAN configuration menu

Following settings can be configured:

- Mode of the IP address assignment
- IP address
- Netmask

- Gateway
- Local TCP Port

Pressing the hotkey “Reset Values” (s. Fig. 145, position 4) will set all menu items to the default values.

The default setting after the first booting of the system is:

| | |
|------------------------------|-----------------------|
| Mode: | Static IP |
| IP Address: | 192.168.77.208 |
| TCP Port for remote control: | 9999 |
| Netmask: | 255.255.255.0 |
| Gateway: | 192.168.77.1 |

Note

A maximum of eight users can be simultaneously connected to the DCU via network.

Mode

The mode of the IP address assignment can be static or dynamic.

If the mode is changed to “**dynamic**”, then the IP address is assigned dynamically by the DHCP server, which means that the DCU gets a random IP address that is currently free. It also means that the IP address can change at any time.

The hotkey “Edit Value” disappears, if the setting “IP Address” is marked and “Mode” is currently set to dynamic.

The presently assigned IP address can be viewed via the "IP Address" setting.

If the mode is set to “**static**”, the IP address of the DCU must be set to a valid fixed value that is not occupied by any other user of the LAN. Once assigned, the static IP address does not change anymore.

- o IP address assignment can be changed directly using the hotkeys “Static IP” and “Dynamic IP” (positions 1 and 2, s. Fig. 145), so that the value of this setting is changed without opening the dialog, or it can be set over the corresponding dialog after pressing the hotkey “Edit Value” (s. Fig. 145, position 3) while this menu point is marked, the following dialog opens (s. Fig. 146).

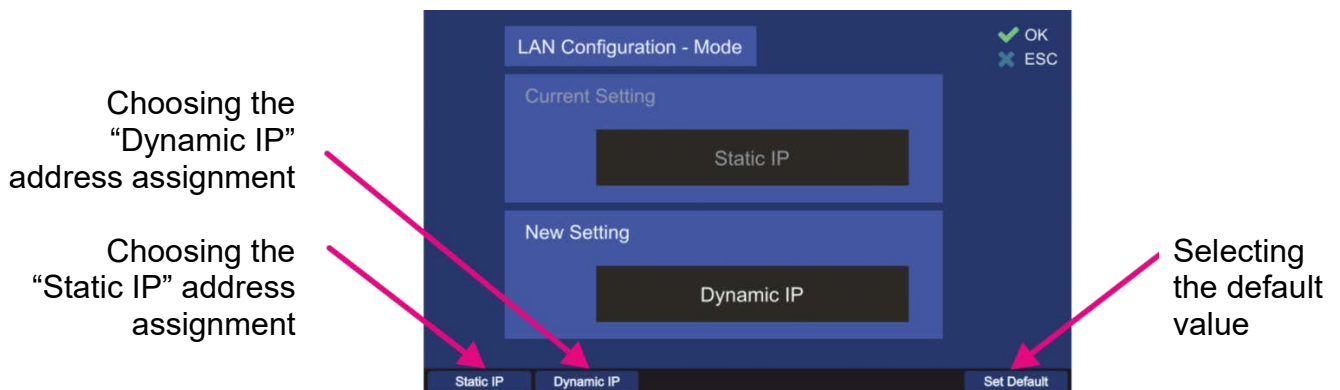

Fig. 146 Changing the mode of the IP address assignment

- Choose the new setting using one of the hotkeys (s. Fig. 146), which will then appear in the “New Setting” field.
- Press the hotkey “Set Default” to use the default value (“Static IP”).
- Confirm the setting with “OK” or leave the dialog without adopting the new value by pressing “ESC”.

IP Address

The IP address can be changed only if “Mode” is set to “Static IP” (dynamic IP address is assigned by the DHCP server).

- For changing the IP address press the hotkey “Edit Value” while this menu point is marked (s. Fig. 145, position 3).
Following dialog opens (s. Fig. 147).

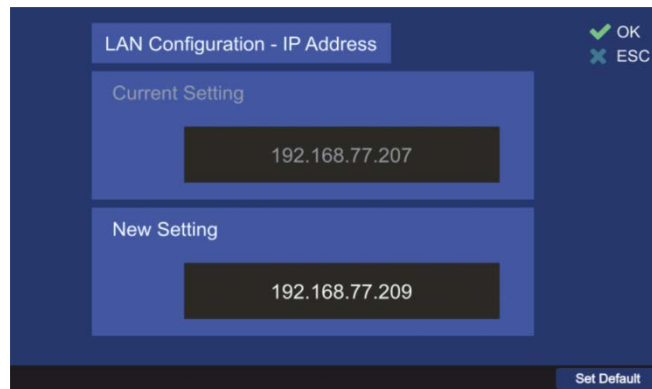

Fig. 147 Setting the new IP address

- Use the number keys of the DCU keypad to enter the new value for the “IP Address” setting.
- Press the hotkey “Set Default” to use the default value “192.168.77.208”.
- Confirm the setting with “OK” or leave the dialog without adopting the new value by pressing “ESC”.

Netmask

The default value for the netmask can be changed if necessary.

- For changing the netmask press the hotkey “Edit Value” while this menu point is marked (s. Fig. 145, position 3).
Following dialog opens (s. Fig. 148).

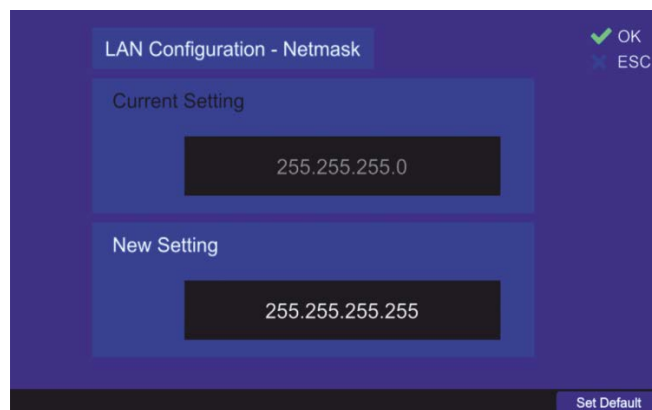

Fig. 148 Changing the netmask value

- Use the number keys of the DCU keypad to enter the new value for the “Netmask” setting.
- Press the hotkey “Set Default” to use the default value “255.255.255.0”.
- Confirm the setting with “OK” or leave the dialog without adopting the new value by pressing “ESC”.

Gateway

The default value for the gateway can be changed if necessary.

- For changing the gateway press the hotkey “Edit Value” while this menu point is marked (s. Fig. 145, position 3).
Following dialog opens (s. Fig. 149).

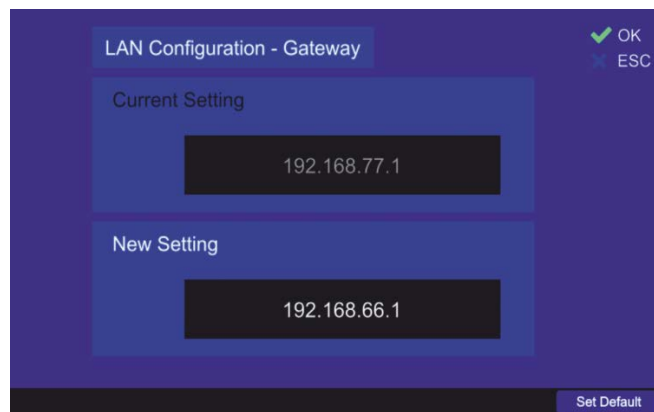

Fig. 149 Changing the gateway value

- Use the number keys of the DCU keypad to enter the new value for the “Gateway” setting.
- Press the hotkey “Set Default” to use the default value “192.168.77.1”.
- Confirm the setting with “OK” or leave the dialog without adopting the new value by pressing “ESC”.

Note

After changing any setting in the “LAN Configuration” dialog, always confirm the changed settings with “OK” on the top level (second time).

- After confirming the changed settings on the top level of the dialog, a dialog for restart the system is opened (s. Fig. 150).

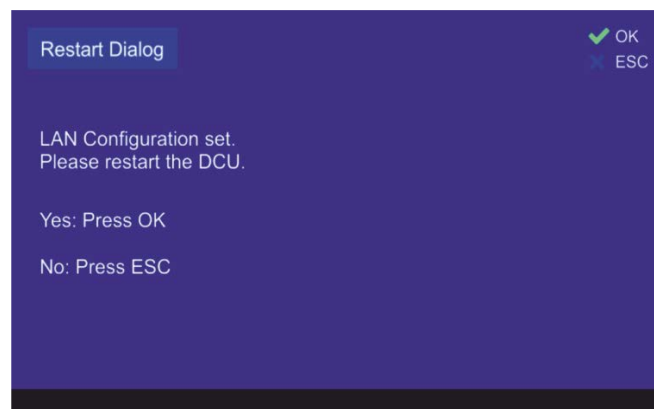

Fig. 150 Restart dialog

Caution

Always reboot the DCU after changing the mode or IP address settings!

Local TCP Port

The default value for the local TCP port can be changed if necessary.

- For changing the port press the hotkey “Edit Value” while this menu point is marked (s. Fig. 145, position 3).
Following dialog opens (s. Fig. 151).

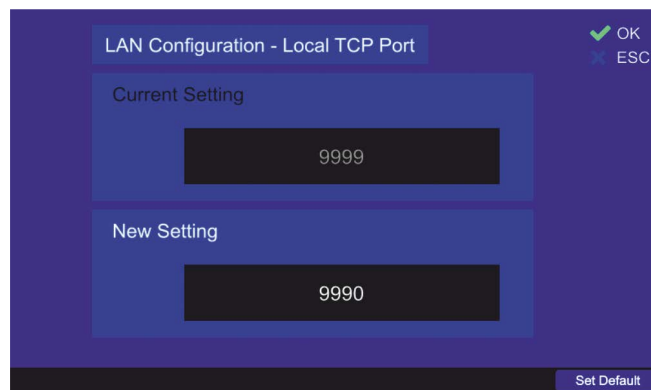

Fig. 151 Changing the TCP port

- Use the number keys of the DCU keypad to enter the new value for the “Local TCP Port” setting.
- Press the hotkey “Set Default” to use the default value “9999”.
- Confirm the setting with “OK” or leave the dialog without adopting the new value by pressing “ESC”.

Note

After changing any setting in the “LAN Configuration” dialog, always confirm the changed settings with “OK” on the top level (second time).

- After confirming the changed settings on the top level of the dialog, a dialog for restart the system is opened (s. Fig. 150).

6.4.4.4 NMEA Compass

An external compass can be connected to the NMEA interface of the DCU.

Configure the interface settings for external compass in this menu item.

- Press the button “OK” or hotkey “Edit Value”, while the setting “NMEA Compass” is marked (s. Fig. 139).
Following sub-menu will appear (s. Fig. 152).

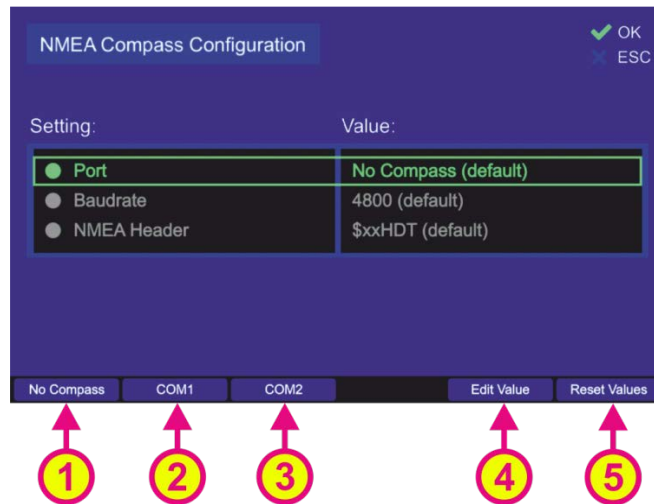

Fig. 152 Compass configuration settings

There are three settings necessary to configure the NMEA compass connection:

- Port
- Baudrate
- NMEA header

Pressing the hotkey “Reset Values” (s. Fig. 152, position 5) will set all menu items to default values.

To go out of dialog confirming all changes, which have been made within the sub-dialogs for the single settings, press “OK”.

Note

Pressing “ESC” instead of “OK” leaving the “NMEA Compass” dialog, all previously configured changes of single settings will not be adopted.

Port

This setting defines, which communication port is connected to the external compass.

- The communication port can be changed by pressing one of the visible hotkeys, e.g.: “No Compass”, “COM1” or “COM2” (s. Fig. 152, positions 1, 2 or 3), or the hotkey “Edit Value” while menu item “Port” is marked (s. Fig. 152, position 4). Using the hotkeys 1, 2 or 3 on the top level dialog “NMEA Compass Configuration” (s. Fig. 152), the value of the “Port” setting can be changed without opening the corresponding dialog.
- Pressing the hotkey “Edit Value” the following sub-dialog will be opened (s. Fig. 153).

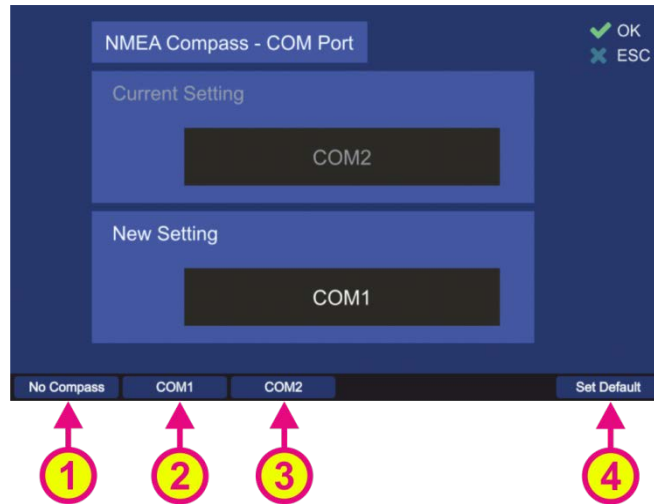

Fig. 153 Compass connector setting

- Choose the new setting using one of the hotkeys (s. Fig. 153), which will then appear in the “New Setting” field. Selecting “COM1” or “COM2” (s. Fig. 153, positions 2 and 3) configures the corresponding communication port as the input port for the external compass data. By choosing “No compass” setting (s. Fig. 153, position 1), the external compass data will be ignored. “No compass” has to be selected, if no external compass is connected, in order to avoid displaying the corresponding warning on the “Bearing” page (“No Compass” warning).
- Press the hotkey “Set Default” to use the default value (“No Compass”).
- Confirm the setting with “OK” or leave the dialog without adopting the new value by pressing “ESC”.

Baudrate

Defines the speed of NMEA interface data transmission.

The default value for baud rate of the NMEA interface is 4800, in compliance with the standard for NMEA 0183, version 3.01. The baud rate can be changed using this menu item. For further information please see the document “NMEA-Protocol Description RT-800”.

- To change the baud rate, press the hotkey “Edit Value” while the menu item “Baudrate” is marked (s. Fig. 152). The corresponding sub-dialog will be opened (s. Fig. 154).

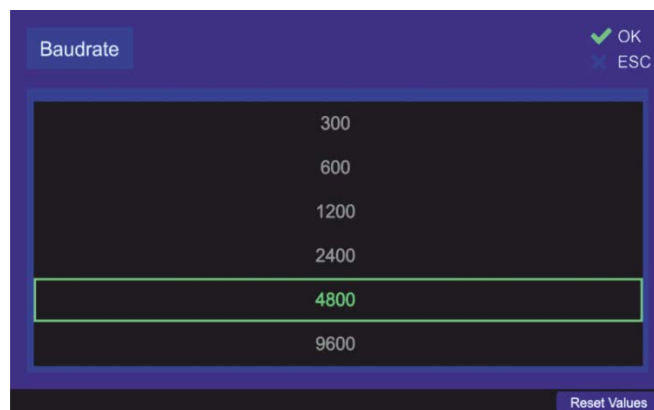

Fig. 154 Compass baud rate setting

- Choose the new baud rate value in the drop-down menu.
- Press the hotkey “Reset Values” to use the default value of “4800”.
- Confirm the setting with “OK” or leave the dialog without adopting the new value by pressing “ESC”.

NMEA Header

Defines the appropriate compass NMEA sentence provided by the compass. Please see the compass documentation.

The default setting for the NMEA header is “\$xxHDT” and can be changed within this menu item.

- In order to change the NMEA header setting, press the hotkey “Edit Value” while the menu item “NMEA Header” is marked (s. Fig. 152). The corresponding sub-dialog will be opened (s. Fig. 155).

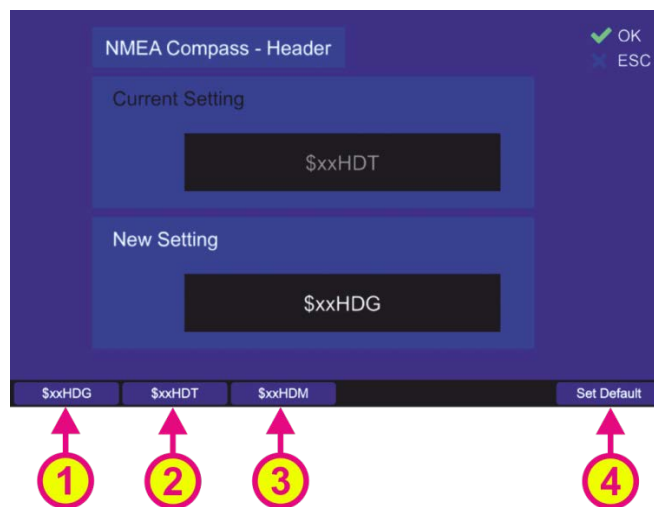

Fig. 155 Compass header setting

- Choose the new setting using one of the hotkeys (s. Fig. 155), which will then appear in the “New Setting” field:
 1. Selecting the “\$xxHDG” (heading, deviation and variation) header (position 1).
 2. Selecting the “\$xxHDT” (true heading) header (position 2).
 3. Selecting the “\$xxHDM” (magnetic heading) header (position 3).
- Press the hotkey “Set Default” (s. Fig. 155, position 4) to use the default value (“\$xxHDT”).
- Confirm the setting with “OK” or leave the dialog without adopting the new value by pressing “ESC”.

6.4.4.5 NMEA GPS

The RT-800 DCU is able to read external GPS data via a defined NMEA protocol. RT-800 supports only the following GPS input sentences:

- GNRMC
- GPRMC
- GPGGA
- GPDTM

Note

The "--RMC" sentence has priority over the "--GGA" sentence.

Connect the external GPS device to COM1 or COM2 interface of the DCU. The GPS data format can be configured in this menu.

- Press the button "OK" or hotkey "Edit Value", while the setting "NMEA GPS" is marked (s. Fig. 139).
Following sub-menu will appear (s. Fig. 156).

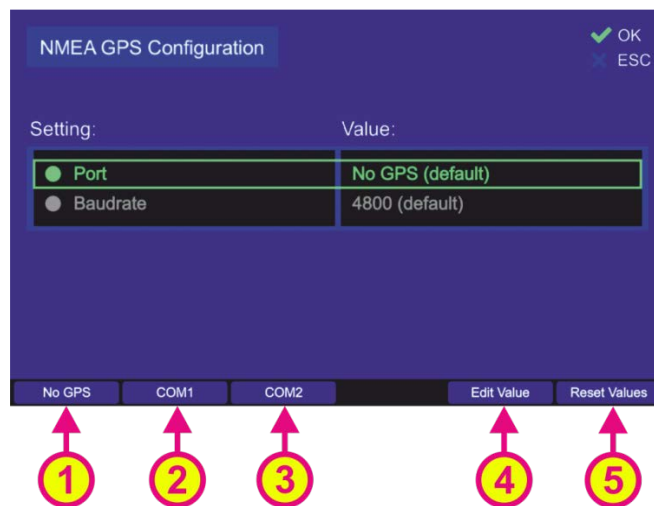

Fig. 156 NMEA GPS configuration settings

The NMEA GPS configuration is accomplished by the following settings:

- Port
- Baudrate
- Pressing the hotkey "Reset Values" (s. Fig. 156, position 5) will set all menu items to default values.
- To exit the dialog confirming all changes that have been made within the sub-dialogs for single settings, press "OK".

Note

Pressing "ESC" instead of "OK" when leaving the "NMEA GPS Configuration" dialog, all previously configured changes of single settings will be discarding.

Port

This setting defines, which communication port is connected to the external GPS device.

- In order to change this setting, press the hotkey “Edit Value” while the menu item “Port” is marked (s. Fig. 156). The corresponding sub-dialog will be opened (s. Fig. 155).



Fig. 157 NMEA GPS communication port settings

- By selecting “No GPS” (s. Fig. 157, position 1) the external GPS data will be ignored.
- Selecting “COM_x 1” (s. Fig. 157, positions 2 and 3) configures the corresponding NMEA interface as the GPS communication port. Choose the new setting using one of the hotkeys, which will then appear in the “New Setting” field.
- Press the hotkey “Set Default” (s. Fig. 157, position 4) to use the default value (No GPS).
- Confirm the setting with “OK” or leave the dialog without adopting the new value by pressing “ESC”.

Baudrate

Defines the speed of NMEA GPS interface data transfer.

The default value for the baud rate of the NMEA GPS communication is 4800. The baud rate can be changed using this menu item.

For further information please see the document “NMEA-Protocol Description RT-800”.

- To change the baud rate, press the hotkey “Edit Value” while the menu item “Baudrate” is marked (s. Fig. 156). The corresponding sub-dialog will be opened (s. Fig. 158).

¹ “x” stands for the number of the interface



Fig. 158 Changing the NMEA GPS baud rate setting

- Choose the new baud rate value in the drop-down menu.
- Press the hotkey “Reset Values” to use the default value of “4800”.
- Confirm the setting with “OK” or leave the dialog without adopting the new value by pressing “ESC”.

6.4.4.6 GPIOs (Power S. Connector)

With this setting, the behavior of the two programmable GPIOs can be defined. The power supply connector (POWER + IO, s. 7.1) provides the “programmable IN” and the “programmable OUT” lines, where different signals can be provided.

- In order to define, which signals are to be allocated to the IOs, select the setting “GPIOs (Power S. Connector)” (s. Fig. 139) and press “OK” or the hotkey “Edit Value”. The following dialog appears (s. Fig. 159).

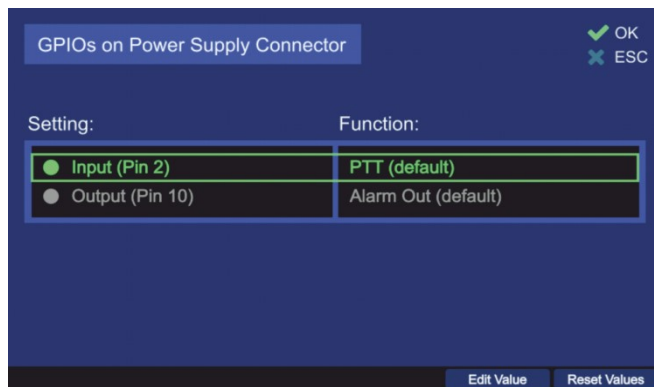

Fig. 159 Dialog for setting the GPIOs

Input (Pin 2)

A signal can be allocated to the “programmable IN” pin (s. 7.1, POWER + IO). There are two setting possibilities for this pin:

1. **PTT**: This setting defines “Pin 2” as a source for the PTT signal. The software will look for PTT signal at this pin as well as at the actual PTT input pin (s. 7.1, POWER + IO). Both sources are valid as PTT source.
2. **No Function**: This setting means that the pin will not be related to any function.

- To configure the programmable input pin, press the hotkey “Edit Value”, while the setting “Input (Pin 2)” is marked.



Fig. 160 Assigning a function to the input pin

- Choose the new setting using one of the hotkeys (s. Fig. 160), which will then appear in the “New Setting” field.
- Press the hotkey “Set Default” to use the default value (“PTT”).
- Confirm the setting with “OK” or leave the dialog without adopting the new value by pressing “ESC”.

Output (Pin 10)

A signal can be allocated to the “programmable pin OUT” (s. 7.1, POWER + IO). There are four setting possibilities for this pin:

1. **Alarm Out**: Choosing this setting connects the programmable output pin with the pin for the alarm relay (s. Fig. 161, position 2).
 2. **Squelch Out**: Choosing this setting (s. Fig. 161, position 3) connects the programmable output pin with the “Squelch Out” pin of the “POWER + IO” connector (s. 7.1).
 3. **Status Out**: Choosing this setting connects the programmable output pin with the internal error status output of the device (s. Fig. 161, position 4). That means, if there are no errors, the output will be active (open collector). If there is an error, the output will be not active.
 4. **No Function**: Choosing this setting allocates the state “No Function” to the programmable pin, which means that the pin is not related to any function (s. Fig. 161, position 1).
- To configure the programmable output pin, press the hotkey “Edit Value”, while the setting “Input (Pin 2)” is marked (s. Fig. 159).



Fig. 161 Assigning a function to the output pin

- Choose the new setting using one of the hotkeys (s. Fig. 161), which will then appear in the “New Setting” field.
- Press the hotkey “Set Default” (s. Fig. 161, position 5) to use the default value (“Alarm Out”).
- Confirm the setting with “OK” or leave the dialog without adopting the new value by pressing “ESC”.

6.4.5 Service

The “Service” menu allows the performing of the service-related functions, like e. g. updating of the DCU software, inputting the new license code if new options have been purchased, etc.

Note

The setup menu “Service” contains critical settings that influence important system parameters therefore it is password protected and can be used only with the administrator access level.

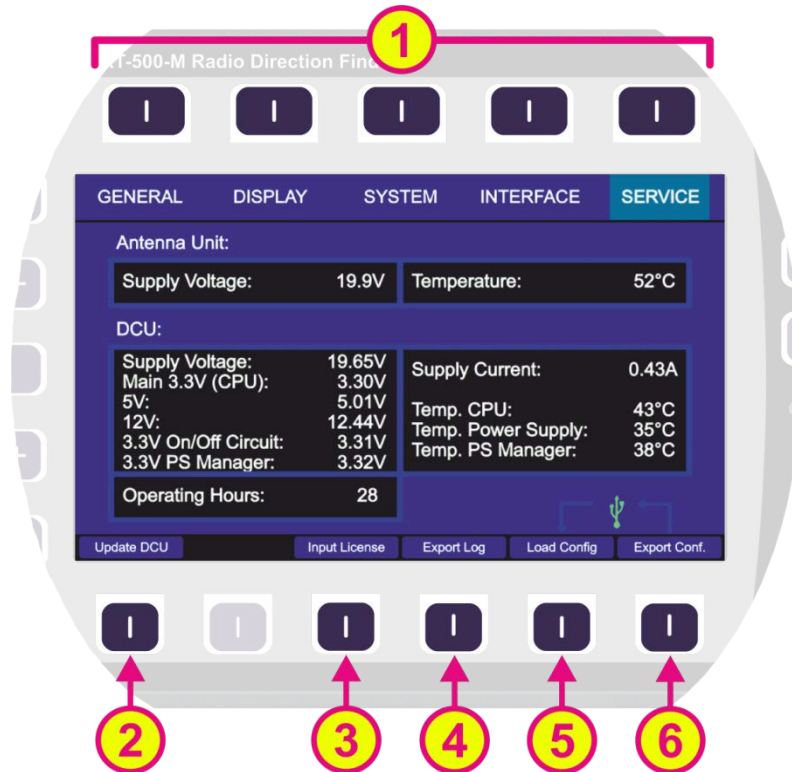

Fig. 162 Setup page. Service menu

| Indication on Setup Page, Service Menu | | |
|--|-----------------|--|
| Pos. | Element | Meaning / Description |
| 1 | Top line | Navigation line of the screen, which allows switching between setup menus (“General”, “Display”, “System”, “Interface” and “Service”). |
| 2 | “Update DCU” | Opens a dialog to start a software update (only for RHOTHETA internal use). |
| 3 | “Input License” | Opens a dialog to input a new license code (s. 6.4.5.1). |
| 4 | “Export Log” | Opens a dialog to export log files to USB (only for RHOTHETA internal use). |
| 5 | “Load Config” | Opens a dialog to import configuration files from USB (only for RHOTHETA internal use). |
| 6 | “Export Conf.” | Opens a dialog to export configuration files to USB (only for RHOTHETA internal use). |

Table 16 Service menu. List of elements

After opening the “Service” menu by pressing the corresponding hotkey, while on the “Setup” page, an information view of the current system parameters opens. Those are the most important working parameters of the AU and DCU, such as temperature or voltage of different functional blocks.

Note

Depending on the connection set-up (cable length, etc.), the supply voltage/current values can slightly differ from the values that e.g., are adjusted on the power supply devices.

6.4.5.1 Input License

If a new license code has been provided to you by RHOTHETA, you can input it using this dialog.

The “Input License” dialog is opened by pressing the corresponding hotkey when the service menu is opened (s. Fig. 162, position 3).

- You can input the new license either manually or load it from the USB flash drive.
- Use arrow buttons of the keypad to navigate between letters of the virtual keyboard in the license input dialog (s. also description of using the virtual keyboard in 6.1.2.6 under “Edit Name Sub-Dialog”).
- Use the number keys of the DCU keyboard for input of the numbers.

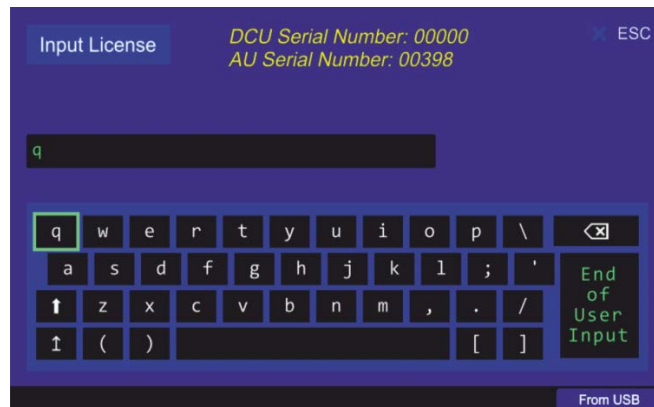

Fig. 163 Input license dialog

- The “From USB” option is only for RHOTHETA internal use.
- After a valid license code was inputted, the device will show the message “Valid License!” and ask for confirming the action of adopting the new license (s. Fig. 164).

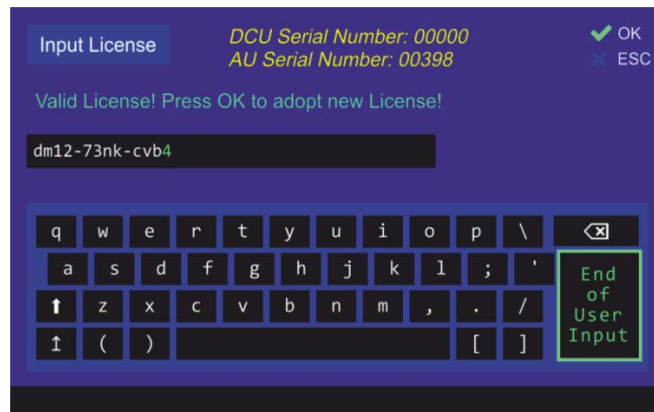

Fig. 164 Input of a new license

- After confirming the new valid license with “OK”, a dialog opens, which requests the restart of the system. (s. Fig. 165).

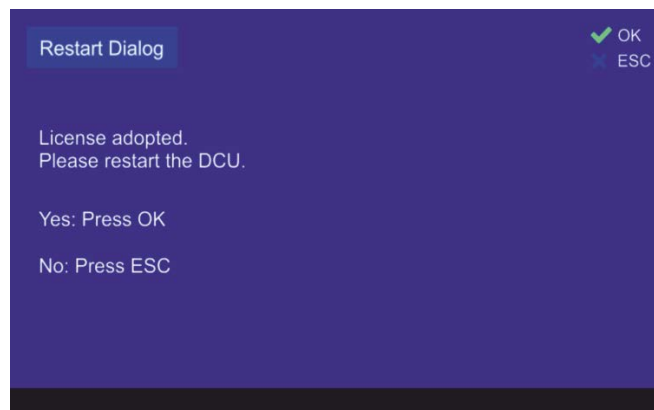



Fig. 165 New license adopted

6.5 Other Operational Functions

6.5.1 Standby Mode

The RT-800 provides a “Standby” mode.

By pressing the button  (s. Fig. 2, position 2), the standby mode is activated, and the button is highlighted in orange. The colored illumination intensity of this button (as well as the “Power” and “Mute” buttons (labeled “Keys”, s. 6.5.4)) can be adjusted in the “Adjust Brightness” dialog (s. 6.5.4).

While in standby, the brightness of the display is driven down to a defined value (configurable in the “Setup” page, s. 6.4.2.9), but the system continues monitoring the corresponding (emergency) frequency, and the keypad stays active.

After the activation of the standby mode the brightness of the legends and “Keys” stays at the previously adjusted value (to turn off the illumination of the legends refer to 6.5.4, to completely turn off the illumination of the “Keys” refer to 6.4.2.9, “STNBY Deactivation”).

Return from Standby:

- Pressing any button as well as the “STNBY” button itself returns the system from standby mode to normal operating mode (the function of the button pressed is not performed at the first press).
- The display is turned on again (by default) when an event occurs, e.g. signal level rises above squelch level, alarm occurs, scan algorithm finds an active frequency or any button (except the “Power” button) is pressed. This behavior can be changed to “Dark Mode” in “Standby Mode Settings” (s. 6.4.2.9).

Note

If the “Dark Mode” is activated while either the main bearing frequency is an emergency frequency or a scan with any emergency frequency is active, the occurrence of the corresponding signal will be indicated by the acoustic alarm even in the “Dark Mode”.

To switch off the alarm, the device must first be returned from the standby mode.

Note

Returning the device from standby mode by pressing the “Power” button does not work!

Especially in the “Dark Mode” the attention must be paid that if this button is pressed continuously for over 2 seconds, the device will be powered off. After turning on again, the device will work in the normal operation mode (not standby mode).

6.5.2 Adjusting the Volume

The volume adjustment button  (s. Fig. 2, position 3) contains two keys: “+” and “-” (twin function key).

Pressing any of the two keys opens the dialog for adjustment of internal and external speaker.

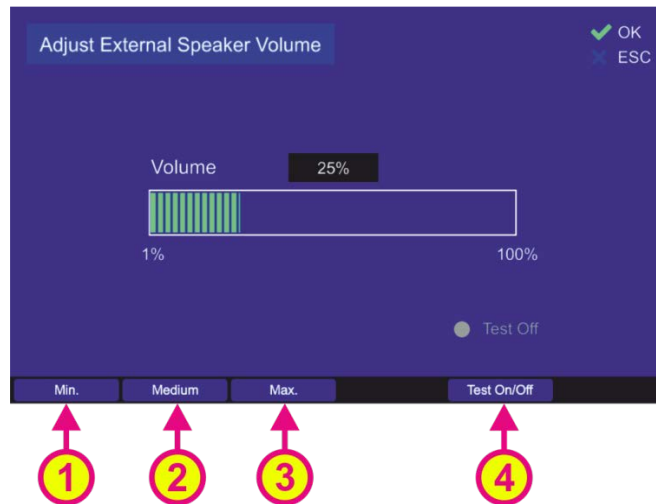



Fig. 166 "Adjust External Speaker Volume" dialog

- Use hotkey "Min." (s. Fig. 166, position 1), "Medium" (Fig. 166, position 2) and "Max." (Fig. 166, position 3) in order to set an appropriate volume.
- Use hotkey "Test On/Off" (Fig. 166, position 4) in order to test volume.

To switch the volume on/off quickly, use the mute-button  (s. Fig. 2, position 4).

6.5.3 Adjusting of the Squelch

The correct adjustment of the squelch is crucial for attaining the optimal sensitivity of the signal reception. The more sensitively the system works, the greater signal range (operating distance) can be achieved. Especially weak signals are often located on the edge to the noise level or even inside the noise level.

Therefore, it is very important to continuously check the squelch level setting and adjust it to the given signal strength and environmental situation in order to use the direction finder system to the full capacity of performance.

- Pushing the button  "+" or "-" (twin function key, s. Fig. 2, position 6): opens the following dialog:

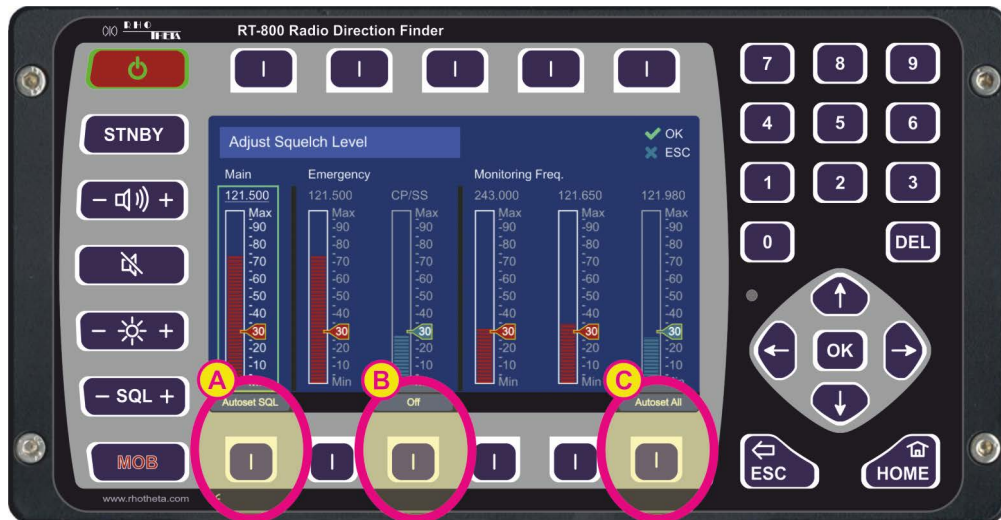





Fig. 167 Squelch dialog

- Pushing the arrow keys   allows switching between the frequencies (green frame indicates the currently chosen frequency).
With the arrow keys   the squelch can be adjusted manually to the desired level in one-percent-steps.

It is also possible to set the squelch level for the main frequency automatically, according to the received signal level. To use this function, push the hotkey “Autoset SQL” (s. field “A”). The squelch can also be turned to the zero level, e.g. for the purpose of receiving very weak signals, which are “hidden” in the noise. The turning off of the squelch is accomplished by pressing the “Off”-hotkey (s. field “B”).

To apply the function of the automatic squelch adjusting to all the stored frequencies press the hotkey “Autoset All” (s. field “C”).



Note

While operating on the noise edge or inside the noise (e.g., in order to find weak signals), the warnings “22” or “23” (s. 13.2) can occur, if the received signal has a positive or negative offset of the currently set bearing frequency. This might be caused by the irregular noise power spectrum distribution.

6.5.4 Dimming and Day/Night Mode

The brightness of the display and key illumination can be adapted to surrounding lighting conditions.

The button  (twin function key, s. Fig. 2, position 5) has two keys (“-”, “+”) to adjust the brightness of:

- “Display”: backlight of the display
- “Keys”: colored illumination of the three buttons:   , which is turned on, when the corresponding function is active.
- “Legends”: backlight of the keypad legends

Pressing one of these keys (“-“ or “+”) will open a dialog with a brightness indication and already decrease or increase the brightness of the marked item.

The brightness can be adjusted in the manual mode as well as in the automatic dimming mode, which is coupled with the light sensor. Further, the dialog shows the current level of the light sensor.

The RT-800 DCU has a “Night” mode available, which facilitates a quick change to the darker color scheme of the display at the push of a button, or automatically, depending on the chosen settings (for night mode settings please see the chapter 6.4.2.10).

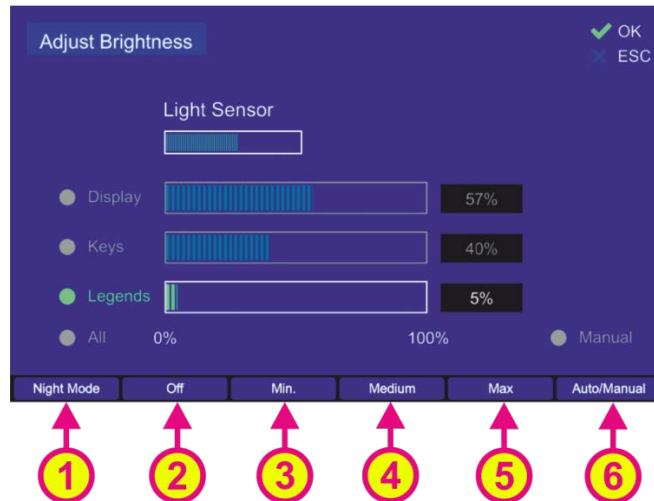

Fig. 168 "Adjust Brightness" dialog

- Use the hotkey “Night Mode” (s. Fig. 168, position 1) to switch over to the night mode manually.

After pressing the hotkey “Night Mode” the display changes to the following color scheme (s. Fig. 169).

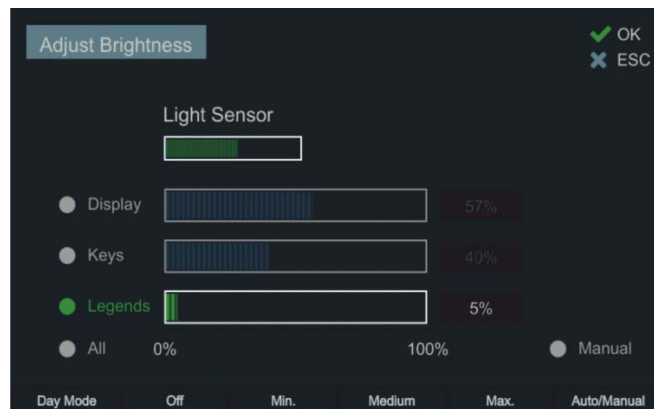

Fig. 169 "Adjust Brightness" dialog in night color scheme

- Use the “Up” and “Down” arrow buttons on the DCU keypad to select between the items to adjust:
 - Display
 - Keys
 - Legends
 - All

- The hotkey “Off” (s. Fig. 168, position 2) is only available if “Legends” is selected. Pressing this hotkey deactivates the illumination of the legends.
- Use the hotkey “Min.” (s. Fig. 168, position 3), “Medium” (s. Fig. 168, position 4) and “Max.” (s. Fig. 168, position 5) in order to set the appropriate luminosity quickly.
- Use “Left” and “Right” arrow buttons of the DCU keypad to increase or decrease brightness of the selected items in one-percent steps.
- Use the hotkey “Auto/Manual” (s. Fig. 168, position 6) in order to set the automatic or manual brightness adjustment mode. The currently selected adjustment mode is indicated above this hotkey.
In the “Auto” mode the luminosity of items will be adjusted automatically based on the light-sensor value.

Note

It is possible to change the brightness settings also in the “Auto” mode. Please, pay attention that this will not simply change the current brightness!

If you change the brightness settings in the “Auto” mode, the new values will be coupled to the light-sensor’s middle position and taken as the starting point for automatic brightness adjustment. Since the brightness is regulated from light-sensor’s zero-point (“Middle”) and has maximum 50 percent-points in both directions, the regulation will not behave equably, when the zero-point was displaced from the “Middle” position.

This means that if e.g., the “Display” brightness was set to “+70%” in the “Auto” mode, it will never reach the “0%” at the “Minimum” point of the light sensor (because the “Middle” of the light sensor is now coupled to the 70% brightness value). The darkest value will then be “20%” (and the brightest will still be 100% as the level 120% does not exist).

- Confirm the changed value with “OK” or press “ESC” to leave the dialog without saving the changes.

Note

Always finish the dimming (day/night mode) adjustment with pressing the “OK” button. Otherwise, the changes will not be saved.

7 Interfaces and Installation

7.1 Power & I/O

S. Fig. 3, position 10.

**Contact
/ Pin**

Signal

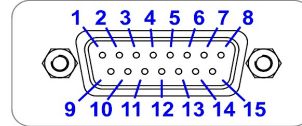

| | | |
|----|--|--|
| 15 | +12 V to +30 VDC | Input power supply DC Caution |
| 8 | GND (Ground) | No connection required (internally connected)! |
| 7 | Permanent Operation | Optional input: external power on Caution No connection required (internally connected)! |
| 14 | PTT / SBS | Optional input in order to suppress self-bearing. When connecting input PTT/SBS (Self Bearing Suppression) to Ground, self-bearing is suppressed. |
| 6 | GND | |
| 12 | Squelch Out | When receiving a signal this pin is connected to ground (active) by the means of an open collector output. Max. current 200 mA. |
| 4 | Alarm Relay | Optional alarm contact (mechanical relay as NOC (Normal Opening Contact)). Max. 1 A at 30 VDC resp. max. 0.3 A at 30 VAC RMS (42.4 V peak) Pin 1 = COM; Pin 4 = NC; Pin 9 = NO |
| 1 | | |
| 9 | | |
| 3 | Speaker + | Optional connection of external speaker. Impedance of speaker: 4...600 Ω, U_{Max} : 8 V _{SS} , Power: 1.5 W _{Max} |
| 11 | Speaker - | Caution No connection required (internally connected)! |
| 13 | Audio Line Out | Symmetric audio exit Adjustable under Setup/General, from 200 mV _{SS} at 10% to max. 2 V _{SS} at 99%, 600 Ohm. |
| 5 | Audio Line Out | Caution No connection required (internally connected)! |
| 2 | Programmable IN (<i>Electrical identical to PTT</i>) | Optional programmable input: - PTT - No function To activate connect to GND. |

| | | |
|----|---|---|
| 10 | Programmable OUT <i>(Electrical identical to Squelch Out)</i> | Optional programmable output (open collector): <ul style="list-style-type: none"> - Alarm - Status - Squelch - No function Max. current 200 mA. |
|----|---|---|

Table 17 Power & I/O Connector

7.2 Antenna Unit (Connecting Cable DCU ↔ AU)

7.2.1 Pinning Antenna Unit Connector

S. Fig. 3, position 5.

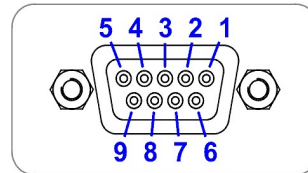

Contact / Pin

Signal

| | | |
|---|------------------------|---|
| 3 | +12 to +30 V DC | Power connection of Antenna Unit |
| 8 | | |
| 5 | GND | Note Power supply includes a shortcut protection |
| 9 | | |
| 1 | RS485 A | Serial data connection DCU ↔ AU (9600 Baud / semi-duplex / receive and transmit) |
| 6 | RS485 B | |
| 2 | NF | Input audio signal resp. analog Test/Service (symmetric OPTIONAL) |
| 7 | GND | Input audio symmetric (OPTIONAL) |

Table 18 Pinning of the AU Connector

7.2.2 Connecting Cable DCU ↔ AU

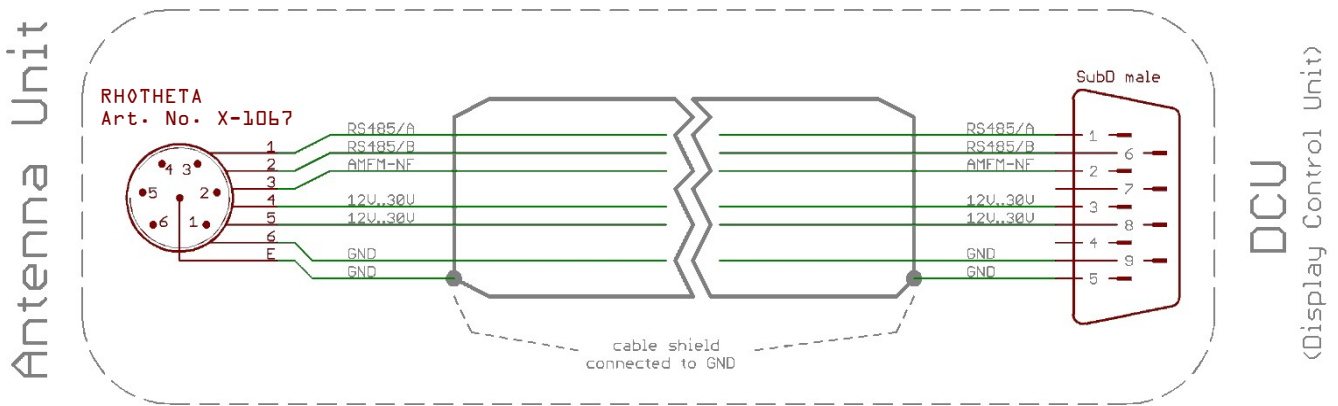

Connection
Antenna Unit

connecting cable 6-poled with shield

Connection
Display Control Unit

Connector type:
RHOTHETA
Article Number X-1067

length 1 to 100 m: cross-section of conductor min.
6 x 0.50 mm²

Connector type:
SubD 9-poled male

7.3 NMEA COM-Interfaces

All 3 COM-Interfaces COM1, COM2, and COM3 (s. Fig. 3, positions 6, 8, 9) have the same pinning.

These interfaces should be used for connection of

- COMPASS of the vessel
- GPS Receiver
- ECDIS (Remote Control)

Note

When connecting to input use either RS232 Rx or RS422 Rx (not both)!

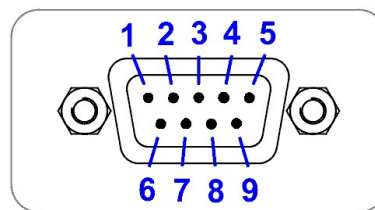

Contact
/ Pin

Signal

| | | |
|---|---------------------|--|
| 2 | RS232 Tx | Output of serial data with RS232 level |
| 3 | RS232 Rx | Input of serial data with RS232 level |
| 5 | GND | GND connection |
| 6 | RS422 Tx / B | Output of serial data with RS422 level |
| 1 | RS422 Tx / A | NMEA 0183 TX |
| 7 | RS422 Rx / A | Input of serial data with RS422 level (isolated) |

| | | |
|---|---------------------|---|
| 8 | RS422 Rx / B | NMEA 0183 RX |
| 4 | NC | Not connected |
| 9 | Power | Power supply for GPS / compass (12V) Note Fuse F3 (T315mA) covers the power supply for all COM interfaces. |

Table 19 Pinning of NMEA Connectors

Note

COM3 is internally connected to MOXA for remote control purposes.

Please do not use this port for other purposes or disconnect MOXA, if MOXA is used for remote control.

7.4 LAN Interface

The LAN interface (s. Fig. 3, position 7) can be used for connection of ECDIS or other Remote and Control Devices (for configuration s. 6.4.4.3).

1 2 3 4 5 6 7 8

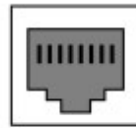
RJ-45
Female

| Contact / Pin | Signal | |
|---------------|---------------|------------------------------|
| 1 | TX+_D1 | Transmit Data+ (10/100BaseT) |
| 2 | TX-_D1 | Transmit Data- (10/100BaseT) |
| 3 | RX+_D2 | Receive Data+ (10/100BaseT) |
| 4 | BI+_D3 | Bi-directional+ (not used) |
| 5 | BI-_D3 | Bi-directional- (not used) |
| 6 | RX-_D2 | Receive Data- (10/100BaseT) |
| 7 | BI+_D4 | Bi-directional+ (not used) |
| 8 | BI-_D4 | Bi-directional- (not used) |

Table 20 Pinning LAN Connector

7.5 Remote Control and IP-Audio Encoder Ports

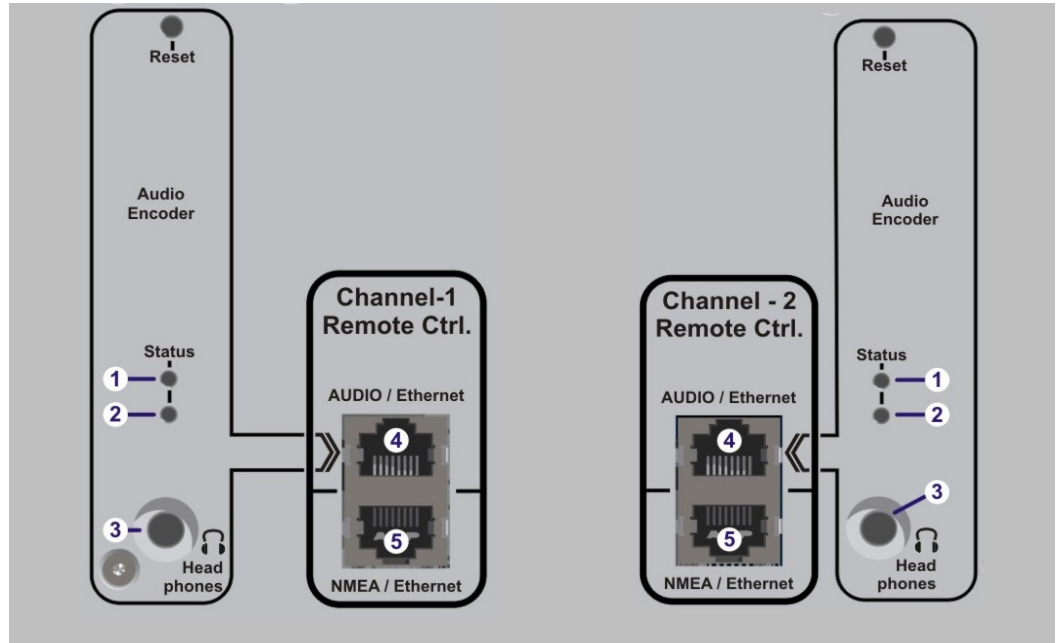

Item Marking

| | | |
|---|-------------------------|---|
| 1 | Status LED (red) | Blinks during the boot process of the IP Audio Encoder |
| 2 | Status LED (green) | Blinking: IP Audio Encoder is sending On: IP Audio Encoder is not sending |
| 3 | Head phones | After switching on the DCU, the current IP-address of the IP Audio Encoder is output to connected headphones. (This is only used during configuration process). |
| 4 | Audio / Ethernet | Ethernet connection of IP Audio Encoder must be connected to LAN (s. chapter 8) |
| 5 | NMEA / Ethernet | Ethernet connection of NMEA remote control must be connected to LAN (s. chapter 8) |

Table 21 IP-Audio Encoder and remote control channels

If the option “2nd Remote Control Channel” is used, it has the same connectors as the Channel-1.

7.6 Power Supply

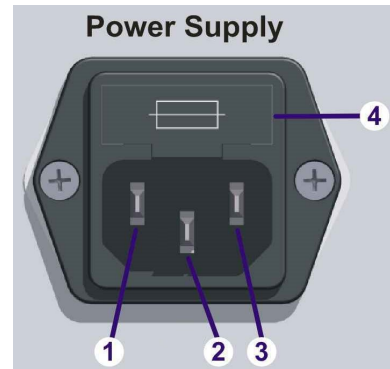

| Item / Pin | Marking | |
|------------|---------------------------------|---|
| 1 | N (Neutral) | IEC 60320 / C14 inlet for use of power cords with IEC 60320 / C13 plugs. 115 – 230 Volts / 1.0 – 0.5 Ampere / 50 – 60 Hz |
| 2 | PE (protective earth) | |
| 3 | L (Line) | |
| 4 | Built-In Fuse (replaceable) | Embedded replaceable Fuse of type IEC 60127 / T5A / 250V / 5x20mm / slow |

Table 22 Power supply connector



Warning

This stationary, plug-in type A equipment has a permanently connected protective grounding conductor. The connection of the protective earth must be carried out by an authorized person.

8 Installation and Configuration

8.1 General Information

For static bearing applications like e.g., VTS (vessel traffic service), a high bearing accuracy is demanded. For this purpose, the antenna unit has to be calibrated in order to compensate minor unbalances in rotation (the RT-800 antenna unit is already calibrated before delivery), but especially the antenna position at the installation site has to be chosen properly.

In case of perturbing site conditions resp. restrictions caused by the building or the environment, the bearing accuracy might be disturbed. This physical effect generally is valid for all bearing systems.

8.2 Installation Recommendation

The quality of the bearing results depends largely on the position of the antenna. A position has to be found, where the transmitter's wavefield can reach the bearing antenna as undisturbed as possible.

If high bearing accuracy is demanded, no metallic resp. RF-conducting obstacles may be located around the antenna unit in an angle of $\pm 45^\circ$ towards the horizontal (s. Fig. 170). The only exception is a correctly installed Lightning Protection Rod, optional available by RHOTHETA.

Objects in the "restricted area" will disturb the arriving wave field. Reflections will arise which might disturb bearing and so decrease the bearing accuracy. This physical effect generally is valid for all bearing systems. In practice, often a compromise has to be found between direction finding and other interests.

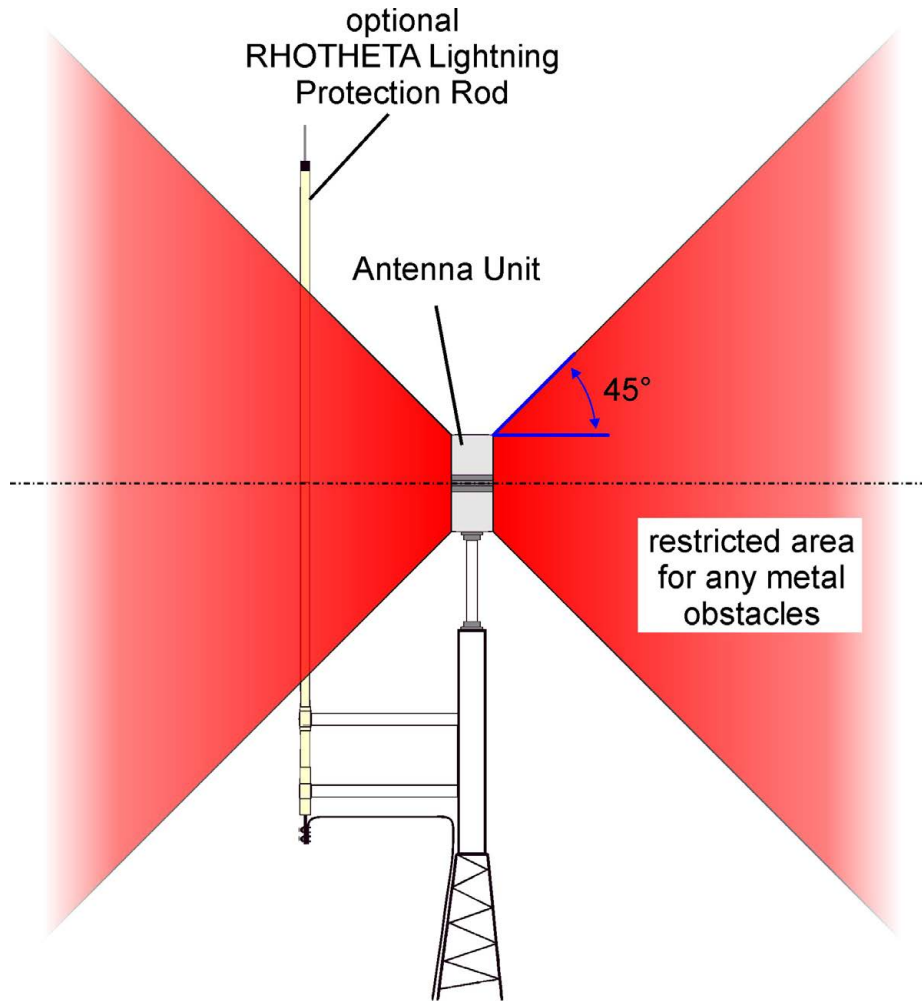

Fig. 170 Example of optimal antenna position

8.3 Line of Sight and Fresnel Zone

There must be a direct line of sight between the transmitter (ship) and the antenna unit. Furthermore, the fresnel zone must be free of any obstacles.

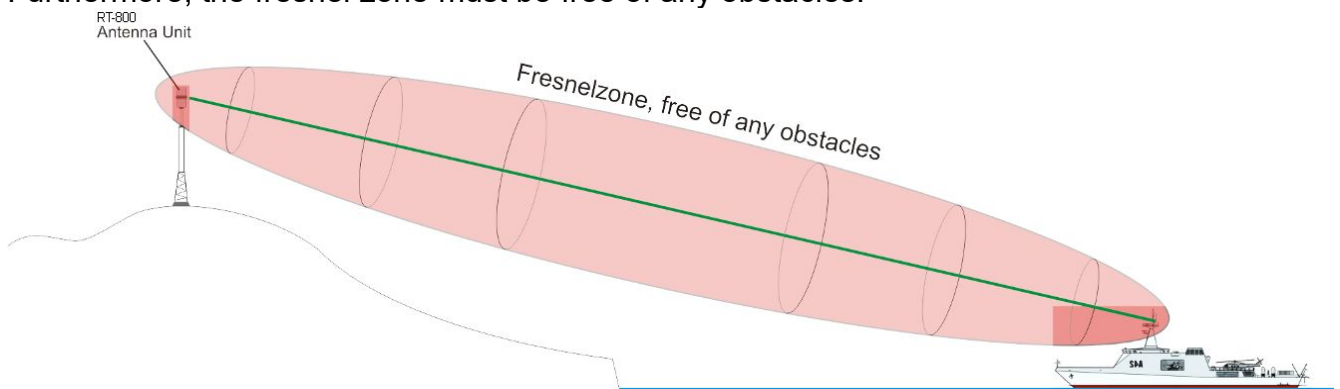

Fig. 171 Line of Sight and Fresnel Zone

In case of obstacles within the fresnel zone, the direct RF-signal is weakened, and possible reflections will be noticeable.

8.4 Reduced Bearing Accuracy Caused by Reflections

Big natural reflectors in the antenna unit's surrounding are especially critical (e. g. mountains in the back-side of the antenna, sharp rocky coasts or forests).

Especially if the directly arriving wave field is very weak due to a remote transmitter, high mountains can cause reflections by receiving the signal better (due to their height) and therefore also causing stronger reflections.

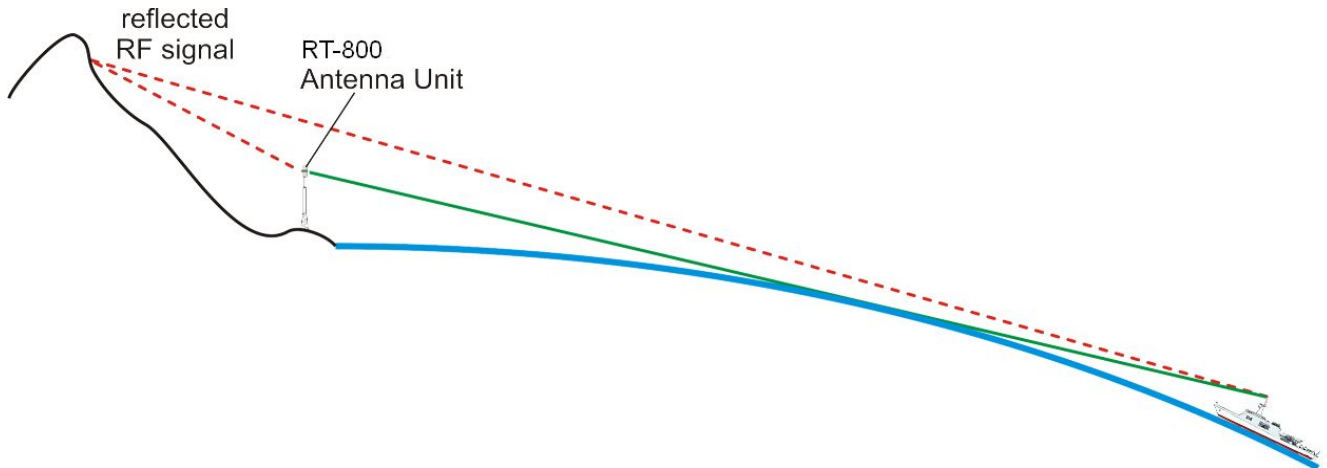

Fig. 172 Reflections at fixed locations

8.5 Overview of favorable and unfavorable Installation Locations

The drawings below show a summarization of effects to be considered while selecting installation sites.

The first one focuses on effects in mountaneous areas, while the second one mainly applies for obstacles within the main lobe of the antenna (refer to chapter 8.2).

For obstacles and disturbance sources within the main lobe of the antenna (refer to chapter 8.2), the same principal recommendations apply for VTS installations as for ATC installations as shown in the second drawing.

Any deviation might lead to an increase in bearing errors beyond the bearing accuracy achieved in reflection-free environments.

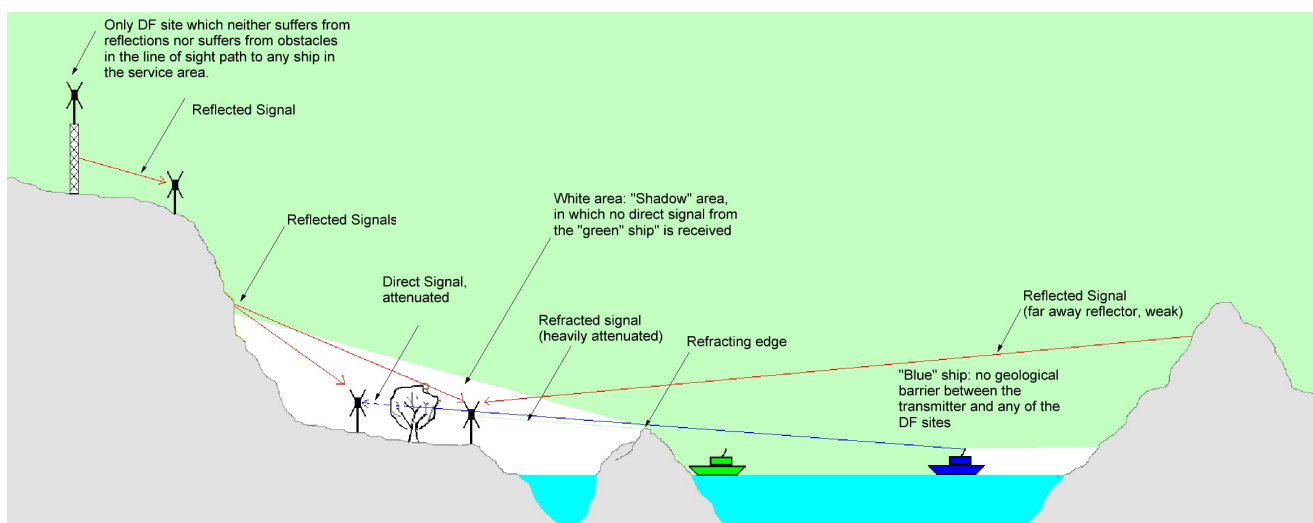

Fig. 173 Illustration of adverse topographical effects

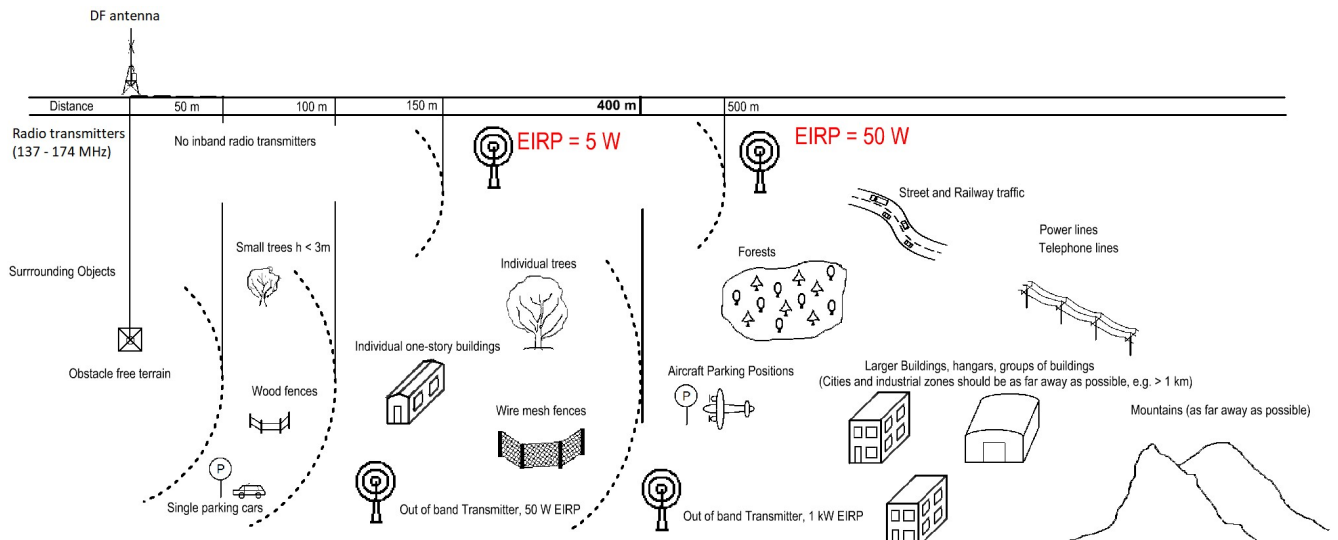

Fig. 174 Illustration of adverse effects in the landscape

8.6 Lightning Protection

When installing the RT-800 (AU) at fixed coastal locations, precautions must be taken regarding lightning protection.

For this reason, RHOTHETA Elektronik GmbH offers an optional Lightning Protection Rod (LPR) for precision direction finders.

The Lightning Protection Rod is designed to protect the direction finder system from the effects of direct lightning strokes.

Conventional lightning protection rods are simple metallic structures that have a great influence on the direction finding accuracy due to reflected radio waves (like any other metallic structure in proximity of the direction finder).

The RHOTHETA Lightning Protection Rod uses special technologies to reduce the reflections. This decreases the effects of the protection rod on the bearing accuracy to an acceptable level, but it does not completely eliminate any influence.

For detailed advice on mounting the Lightning Protection Rod please refer to the Installation Manual of Lightning Protection Rod.

8.7 Antenna Alignment

Bearing values of RT-800 are always displayed and output **relatively to the “North / 0°”** marking of the antenna unit (s. Fig. 175).

This implies that the north marking must be aligned to North in order to display absolute, north related values.



Fig. 175 North / 0° marking of Antenna Unit

8.8 Antenna Connection

For details about the connection between the RT-800 DCU and AU please refer to chapter 7.2.

8.9 DCU Configuration

8.9.1 Interface Configuration

For details about the DF configuration for remote control please refer to chapter 6.4.4.2.

Internally the control panel of the RT-800 (display with buttons) is connected to a serial-to-ethernet converter by a serial line.

This implies that the **same** serial configurations must be used in both, the DCU and the serial-to-ethernet converter. Configuration of serial-to-ethernet converter is described in chapter 8.10.

Standard configuration is:

4800 Baud / 8 databits / 1 stopbit / no parity / no flow control

It is strictly not recommended to change these values.

8.9.2 Audio Line Output Configuration

RT-800 CDU audio output consists of two parts:

1. The first audio output is connected directly to the internal speaker and its volume can be controlled by the “Volume” dialog of the DCU (s. 6.5.2).
2. The second audio output is connected to the input of the IP Audio converter. With the “Audio Line Output” setting (s. 6.4.1.3) the level of this audio signal can be adjusted from 0% to 100% (200 mV_{SS} to max. 2 V_{SS}).

8.9.3 Antenna Unit Configuration

If the antenna unit is not possible to mount in the standard position, the upside-down correction can be adjusted by a correct setting of “Antenna Unit” (s. 6.4.3.2).

If a bearing offset is present after mechanical installation of the RT-800 AU (antenna unit is not exactly aligned to North), this offset can be compensated using the “Antenna Mechanical Correction” setting (s. 6.4.3.3).

For two different purposes of use (fixed or mobile installation) the setting “Antenna Installation” can be set (s. 6.4.3.4).

8.10 Configuration of Remote Control over IP

See also 8.13 Example of complete Network Scenario.

8.10.1 General

The RT-800 display control unit is already prepared to be connected via the NMEA/Ethernet connector to an IP-based Ethernet LAN, making it possible to access the direction finder located anywhere on a local LAN, or the Internet.

For this, the RT-800 DCU contains an industrial device server (MOXA NPort 5150) which is internally connected to serial line signals.

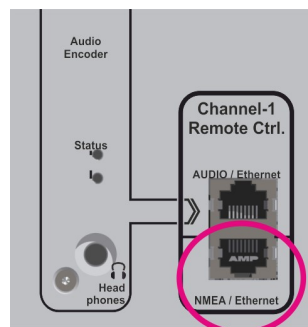

Fig. 176 Remote Control LAN connector

The MOXA NPort 5150 device supports several operation modes (TCP, UDP, Pair connection etc.) and some configurations must be done in any case by the user, for proper operation at customer specific IT environment conditions.

For additional detailed information, see also www.moxa.com > support > NPort 5150.

The next chapters describe the exact configuration for best performance of this MOXA device using a standard web console.

8.10.2 IP Network Settings & Web Console Connection using MOXA

To access the direction finder from remote, it is common to use static IP & Port addresses. The MOXA device itself can be configured to a static IP address or (which is usually the better solution) the router can be configured with a DHCP reservation in the local network, to allocate the direction finder (identified by its MAC address) to a fixed/static IP address.

- RT-800 is preconfigured after delivery to **DHCP mode**
- If NO DHCP server is available, the initial RT-800 IP address **192.168.127.254**

A standard Web Browser/Console is the most user-friendly method available to configure the MOXA NPort 5150 and thus the RT-800 network connectivity. You can use as example Google Chrome or the Microsoft Internet Explorer.

- Connect the RT-800 NMEA/Ethernet port to your local LAN network.
- If a DHCP server is available in your network, the RT-800 will get an initial IP address depending on your DHCP router settings. You can use an IP scanner or just look at your router configuration console or as example windows DHCP server at the new clients table to see the actual RT-800/MOXA IP address.
 - Name of the RT-800/MOXA device = "np5150_ ..."
 - Manufacturer ID = "MOXA ..."
- If NO DHCP server is available, the RT-800 will use the factory default IP address 192.168.127.254. In this case you have to configure the computer you use for this configuration temporarily also to a static IP address of the same subnet 192.168.127.xxx

Network configuration:

- Start a standard web browser console and input the actual detected IP address of the RT-800 / MOXA device. Default password is: **moxa**.

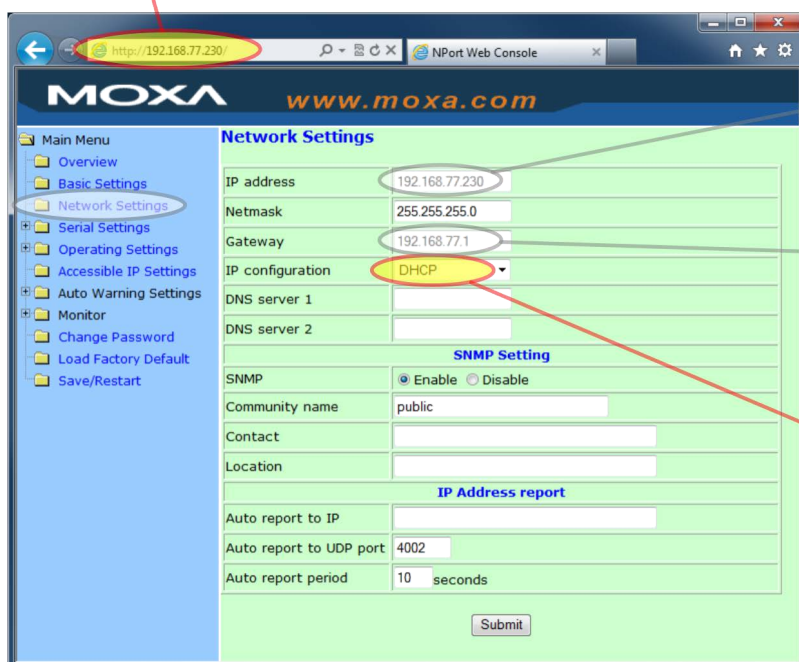

Actual IP address.
Changed/configured only when not working with DHCP.

Gateway information of local network is always necessary if the remote control is done from another network. When DHCP mode is active and available, the gateway values are normally automatically filled.

Setting for DHCP or static mode possible. Depends on your network configuration.

MAC address info:

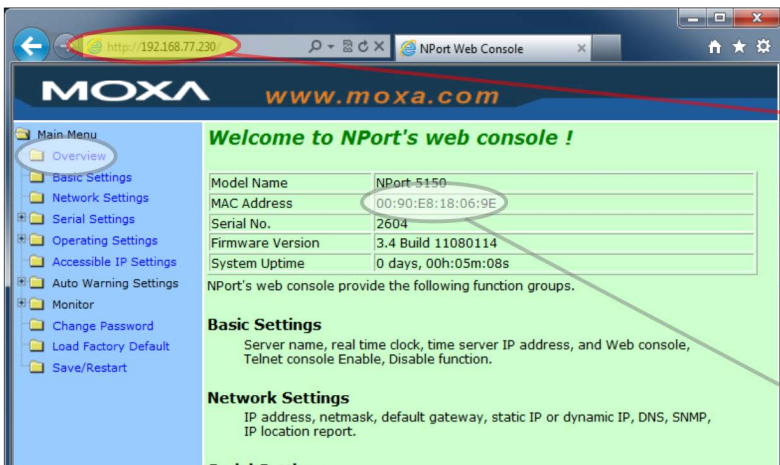

Fixed MAC address of the RT-800 / MOXA device.

Used for DHCP router reservation table.

Basic Infos:



Name of RT-800 / MOXA device.

Internal serial Settings

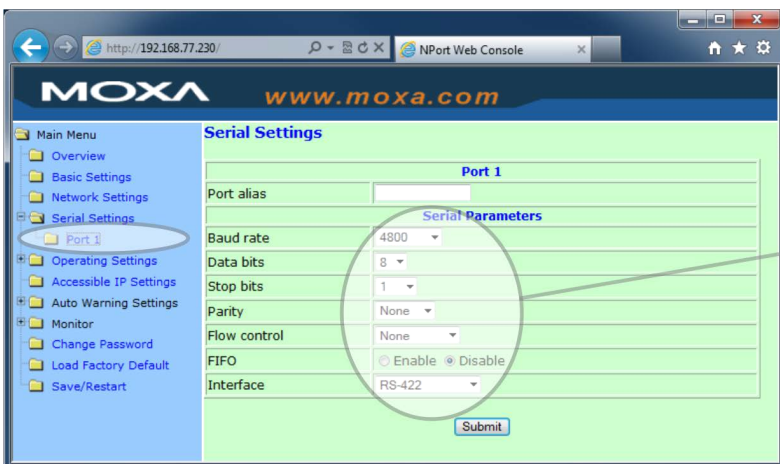

Attention:
Any change of this values will result in no more proper operation of the RT-800.

➤ Do not change

Operating (TCPIP) settings:

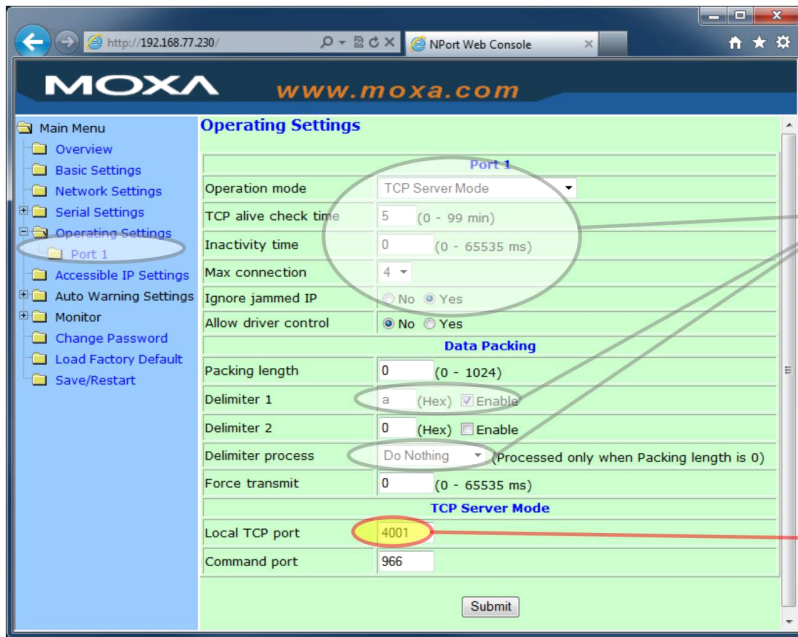

Strictly recommended configuration for a TCPIP connection. With this settings, each RT-800 NMEA output sentence will be packed in one Ethernet package. Up to 4 independent simultaneous active TCPIP connections are possible.

TCP Port for RT-800 NMEA protocol data

8.11 Configuration of Audio over IP (streaming into LAN)

See also 8.13 Example of complete Network Scenario.

8.11.1 General

The RT-800 display control unit is already prepared to be connected via the AUDIO/Ethernet connector, for streaming the audio signal to the Ethernet LAN (voice over IP).

The RT-800 DCU contains an industrial audio streaming device / live IP audio encoder (BARIX Instreamer) for this purpose.

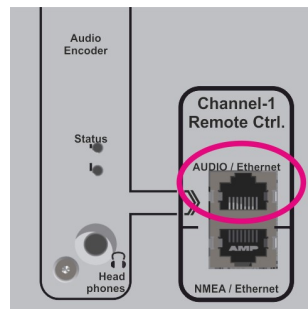

Fig. 177 Audio streaming to LAN connector

The BARIX Intreamer device supports a lot of streaming modes also for custom specific conditions. The device is already pre-configured for two simultaneous streaming modes.

- **B RTP:** Barix extended protocol. The use of this mode is strictly recommended. It offers very fast reaction time even for short voice communication audio signals on VTS/ATC applications. This protocol can only be used, if at the remote control site a BARIX Exstreamer is used. This optional additional small device is described at the next chapter.
- **HTTP as Internet Radio.** This stream can be decoded as example directly from the remote application with a VLC player. Because it uses larger streaming buffers, the

delay times can increase up to a few seconds, which is mostly unwanted for short signals.

For additional detailed informations, see also www.barix.com (Instreamer, Exstreamer)

8.11.2 IP Network settings & Web Console Connection

To access the direction finder audio from remote, it is common to use static IP & Port addresses. For this the Barix device itself can be configured to a static IP address or, which is normally the better solution, to configure the router in the local network with a DHCP reservation to allocate the direction finder audio identified by its MAC address to a fixed/static IP address.

- The RT-800 Audio/Barix device is preconfigured after delivery to **DHCP mode**.
- If **NO DHCP** server is available and no static IP mode is configured, it can take up to 4 minutes before the IP address will be announced over the speaker.

The actual RT-800 audio IP address will be announced after Power On of the RT-800 over the headphone connector near the Audio/LAN connector on the back side.

A standard Web Browser/Console is the most user-friendly method available to configure the Barix Instreamer audio device.

- Connect the RT-800 NMEA/Ethernet port to your local LAN network.

Network configuration:

- Start a standard web browser console and input the actual detected/static IP address of the RT-800 Audio Barix device.
At the example shown here, the IP address is assigned by a DHCP server to 192.168.77.232

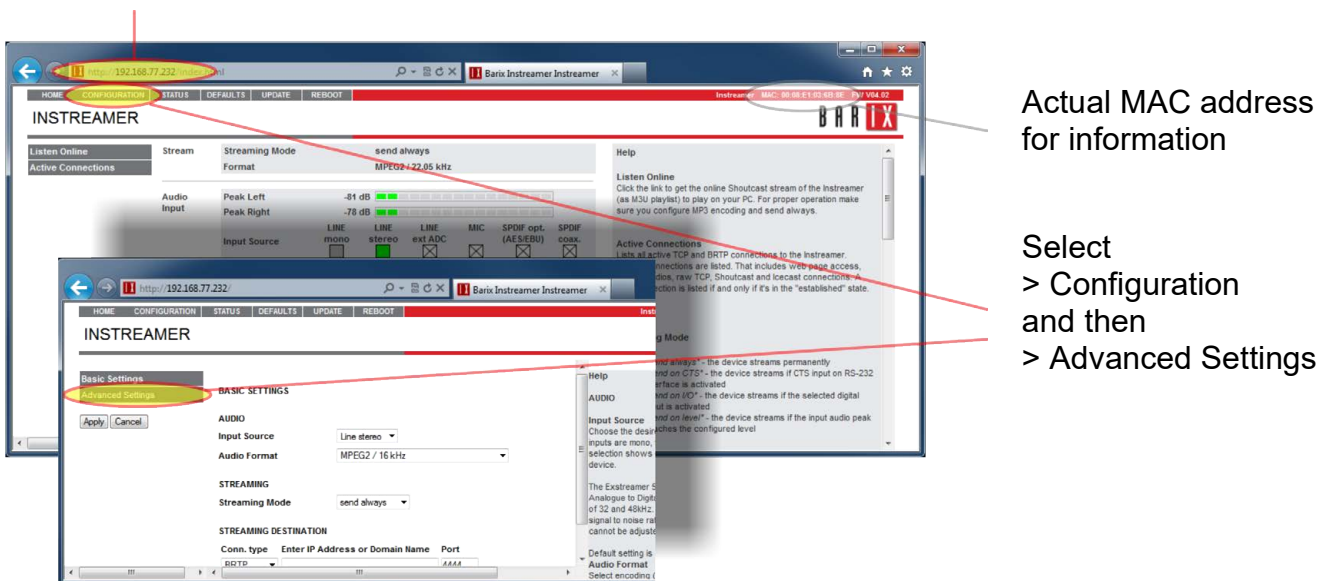

Actual MAC address for information

Select > Configuration and then > Advanced Settings

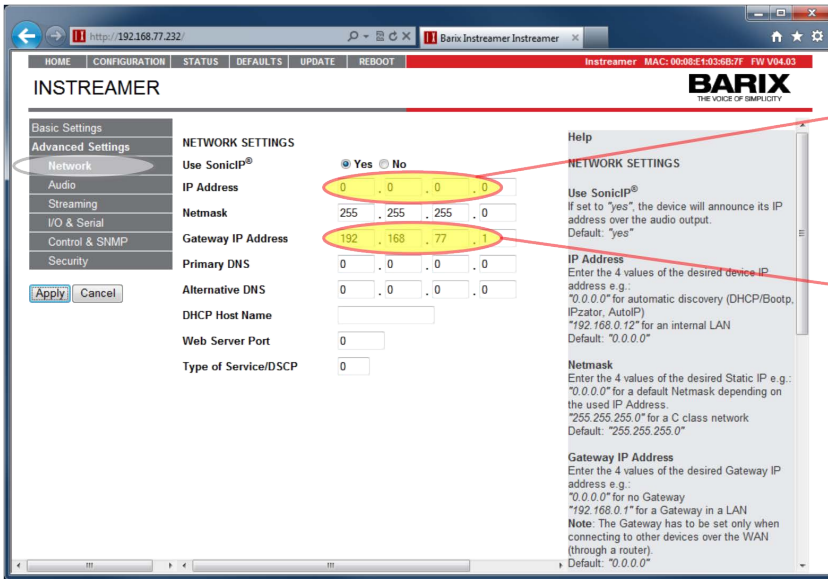

"0.0.0.0" for automatic DHCP mode

or any valid static IP address

Valid Gateway address if routing/streaming to other devices outside the local network.

Audio configuration:

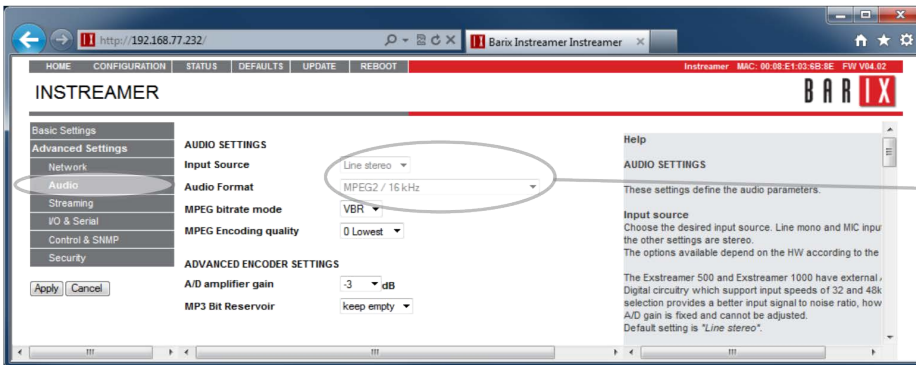

recommended audio settings

Streaming configuration:

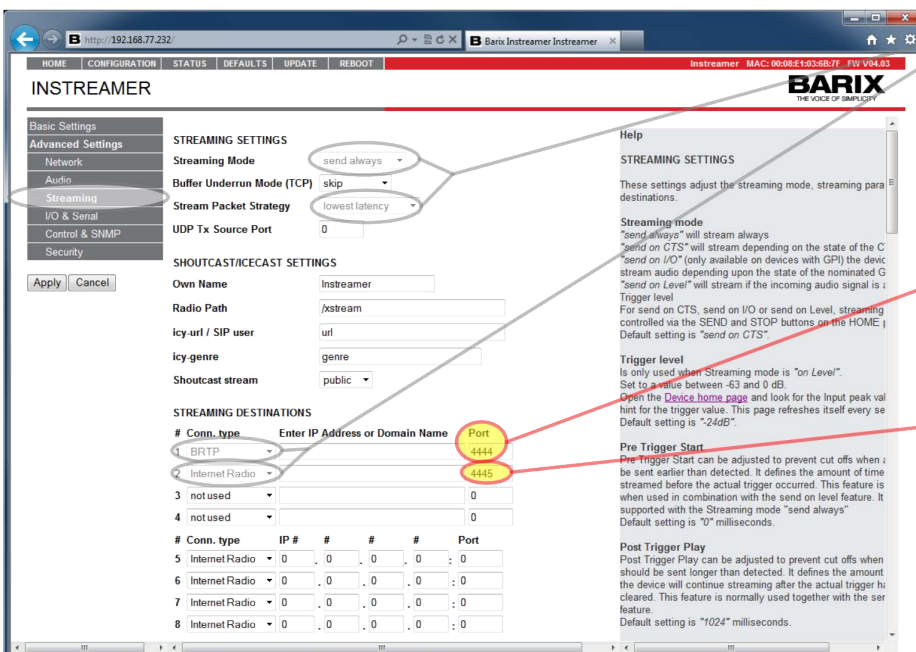

recommended settings

Individual port value for BTRP protocol

Individual port value for second optional Internet radio (VLC) protocol

8.12 Configuration of Audio Exstreamer (streaming from LAN)

See also 8.13 Example of complete Network Scenario.

For the remote control site audio generation, this optional additional small stand alone device is the recommended solution and provided by RHOTHETA. This device (Exstreamer) decodes audio streams and play out the received audio signals to amplifiers or speakers. Supporting a large number of protocols, encoding methods and application specific firmware, the products can be used for Broadcast, Internet Radio, as well as VoIP applications.



Front side:
Headphone connector

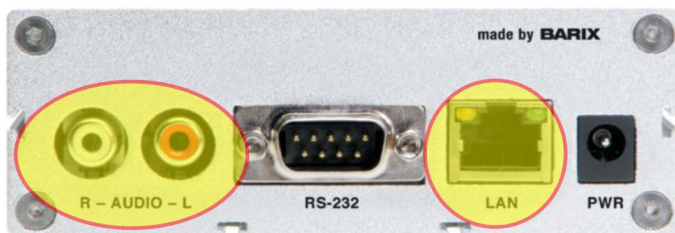

Back side:
Line out for connection
to an amplifier or active
speakers.
LAN connector

8.12.1 Configuration of Extreamer at Remote Site

The BARIX Exstreamer device is also configured with any standard web browser/console.

The IP address will be announced after Power On over the headphone connector. This can take up to 4 minutes if no DHCP server is available at the connected LAN network.

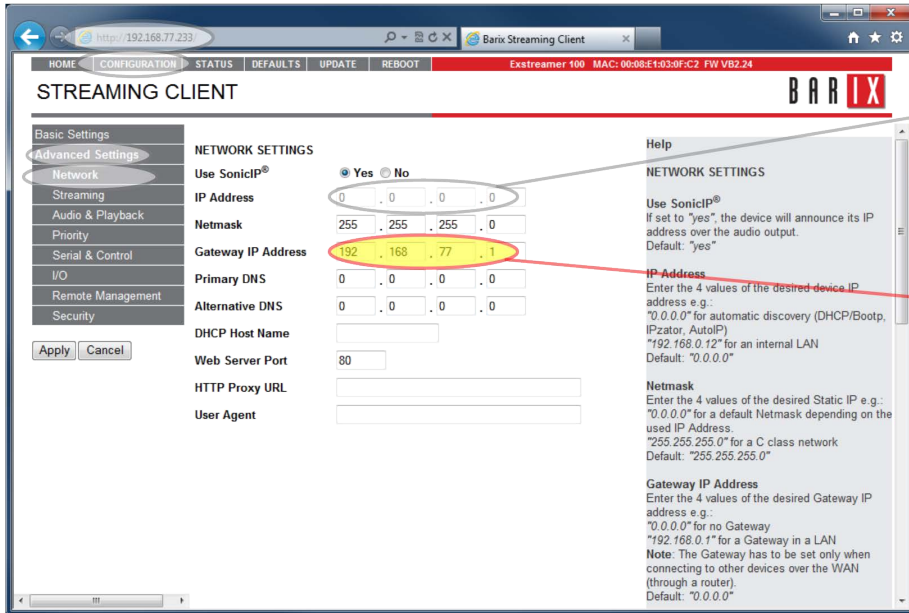

The IP address for this Exstreamer is preconfigured to DHCP

Please input here the Gateway address if the RT-800 is not in this LAN

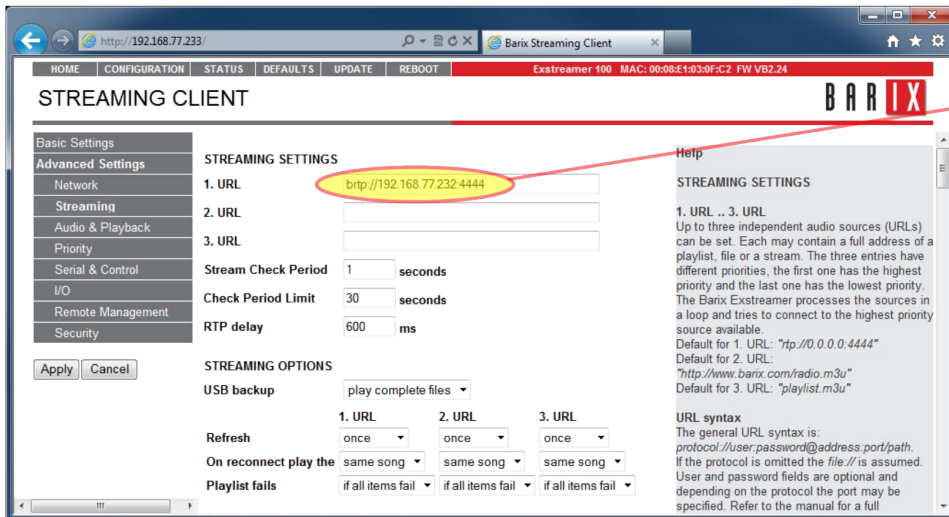

Please input here the accurate Source IP address of the RT-800 and the used Port.

8.13 Example of complete Network Scenario

In this example a complete network scenario is shown. A public Internet connection with port forwarding is used.

For professional uses, with e.g. VPN connection, no port forwarding is necessary because then all devices are working (virtually) in the same network without the use of gateway addresses

All IP addresses and port values are just example values and can be configured.

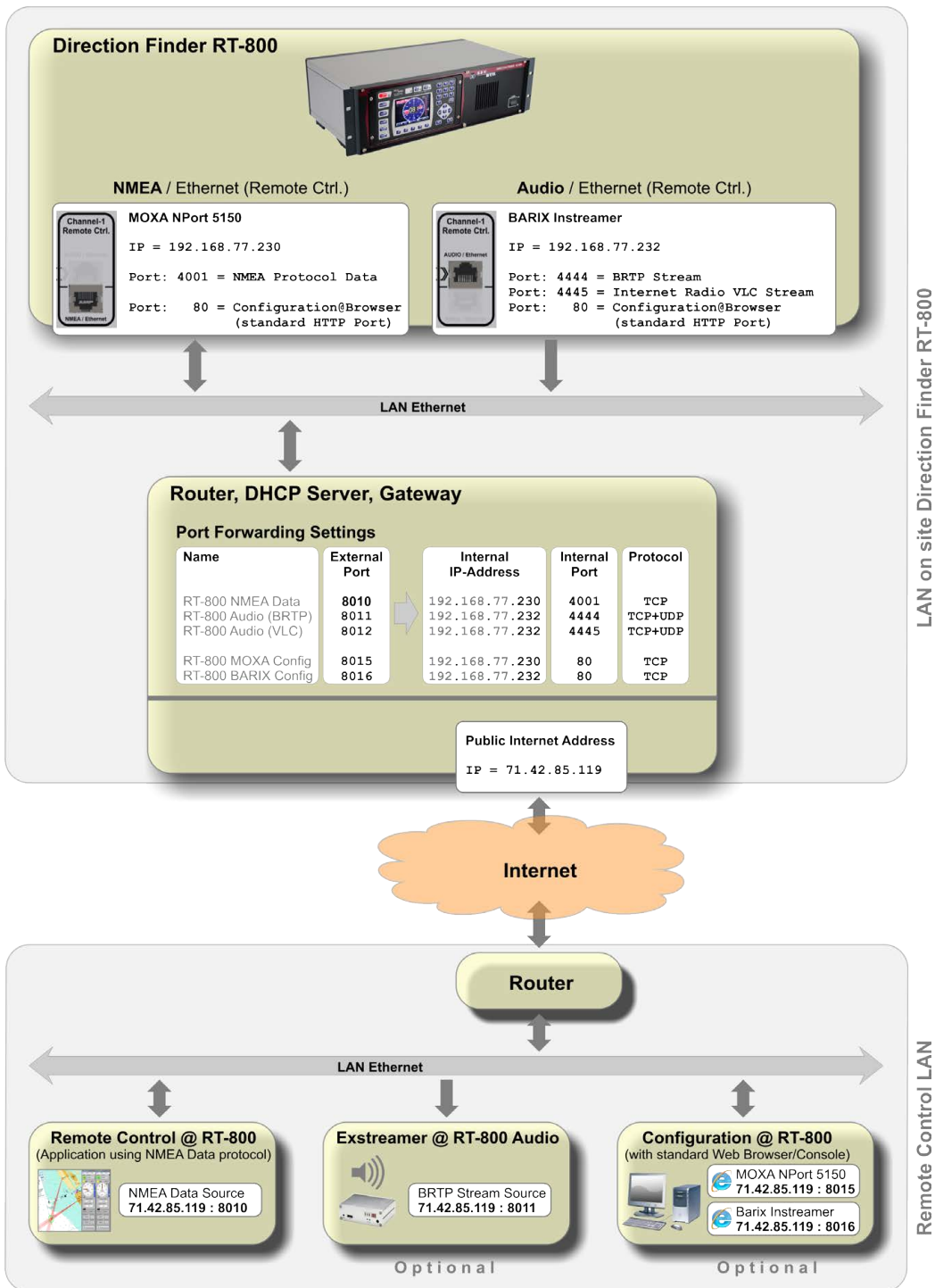

Fig. 178 Example of complete Network scenario

9 Technical Data

9.1 Electrical Characteristics

| System Characteristics | | |
|---|------------------------------------|--|
| Parameter | Condition | Data |
| Method of Bearing | | Doppler (3 kHz rotation frequency) |
| Bearing Accuracy | | $\leq 2^\circ$ RMS ¹ |
| Display Resolution | | 1° |
| Minimum Signal Duration | | ≤ 100 ms |
| Frequency Range | VHF Air Band | 118.000 – 124.000 MHz 118.000 – 136.992 MHz (Option F1) |
| | VHF Marine Band | 154.000 – 163.000 MHz 137.000 – 224.995 MHz (Option F2) |
| | UHF Air Band | 240.000 – 246.000 MHz 225.000 – 399.975 MHz (Option F3) |
| | COSPAS-SARSAT | 400.000 – 406.092 MHz |
| | UHF FM-Band | 406.100 – 410.000 MHz 406.100 – 470.000 MHz (Option F4) |
| Receive Frequency Tuning Steps | VHF Air Band | 8.33 kHz |
| | Marine Band | 5 kHz |
| | UHF Air Band | 25 kHz |
| | COSPAS-SARSAT | 8.33 kHz |
| | UHF FM-Band | 5 kHz |
| Bearing Sensitivity Continuous Signal ($\pm 5^\circ$ bearing fluctuation) | VHF Air Band | $\leq 4 \mu\text{V/m}$ / $2.5 \mu\text{V/m}$ typical |
| | Marine Band | $\leq 3 \mu\text{V/m}$ / $2 \mu\text{V/m}$ typical |
| | Extended Marine Band above 174 MHz | $\leq 5 \mu\text{V/m}$ / $3 \mu\text{V/m}$ typical |
| | UHF Air Band | $\leq 6 \mu\text{V/m}$ / $4 \mu\text{V/m}$ typical |
| | COSPAS-SARSAT | $\leq 6 \mu\text{V/m}$ / $4 \mu\text{V/m}$ typical |
| | UHF FM-Band | $\leq 6 \mu\text{V/m}$ / $4 \mu\text{V/m}$ typical |

| System Characteristics | | |
|------------------------------|------------------|--|
| Parameter | Condition | Data |
| Bearable Types of Modulation | | A3E, F3E, A3X (distress signal modulation) |
| Polarization | | Vertical |
| Scanning | | Multiple scanning and monitoring functions available |
| COSPAS-SARSAT Functionality | | <ul style="list-style-type: none"> ○ Scanning of all 19 COSPAS-SARSAT channels ○ Decoding of COSPAS-SARSAT Message: shows beacon ID, GPS position and whole message string (short and long) ○ Displays direction and distance to beacon². |
| TFT Graphic Display | | <ul style="list-style-type: none"> ○ 5" (127 mm), 24 bit RGB 800 x480 x 3 dots ○ Max. brightness: > 500 cd/ m² (typical 800 cd/m²) ○ Dimming: manual and automatic |
| Audio | Internal Speaker | 1 W, 8 Ohm |
| | External Speaker | 1 W, 8 Ohm |
| | Line out | Adjustable from 200 mV _{pp} to 2 V _{pp} |
| Operating Voltage | | 110 – 230 VAC / 50 – 60 Hz |
| Power Consumption | | Nominal 30W @ 230V |
| Current Consumption | | Max 1A typical 0,1A @ 230VAC typical 0,2A @ 110VAC |
| Interfaces | | <ul style="list-style-type: none"> ○ 3x NMEA 0183 (RS422) 3x RS232 ○ Ethernet LAN (NMEA over LAN) ○ Alarm Relay Output (1 A, 30 V DC / 0,3 A, 30 VAC RMS) ○ PTT input for self-bearing suppression ○ Squelch output for external audio controlling ○ 2 x programmable I/O ○ Ethernet Interface for IP Audio output (e.g., Internet Radio, RTP RawUDP, RawTCP, SIP, Icecast, Shoutcast) ○ Headphone (only used for setup of IP Audio) |
| Real Time Clock Battery | | <ul style="list-style-type: none"> ○ Battery Type: CR2032 Lithium Cell 3V (solid soldered) |

Table 23 Electrical characteristics

¹ Measured with un-modulated, undisturbed wave field at field strength ≥ 20 dB above sensitivity level by changing the angle of incidence with the antenna rotating on a revolving table in order to eliminate environmental influences on the results.

² If GPS data is available at NMEA interface.

9.2 Mechanical Characteristics

9.2.1 DCU Dimensions (built-in version)

Measuring units: [mm] millimeters

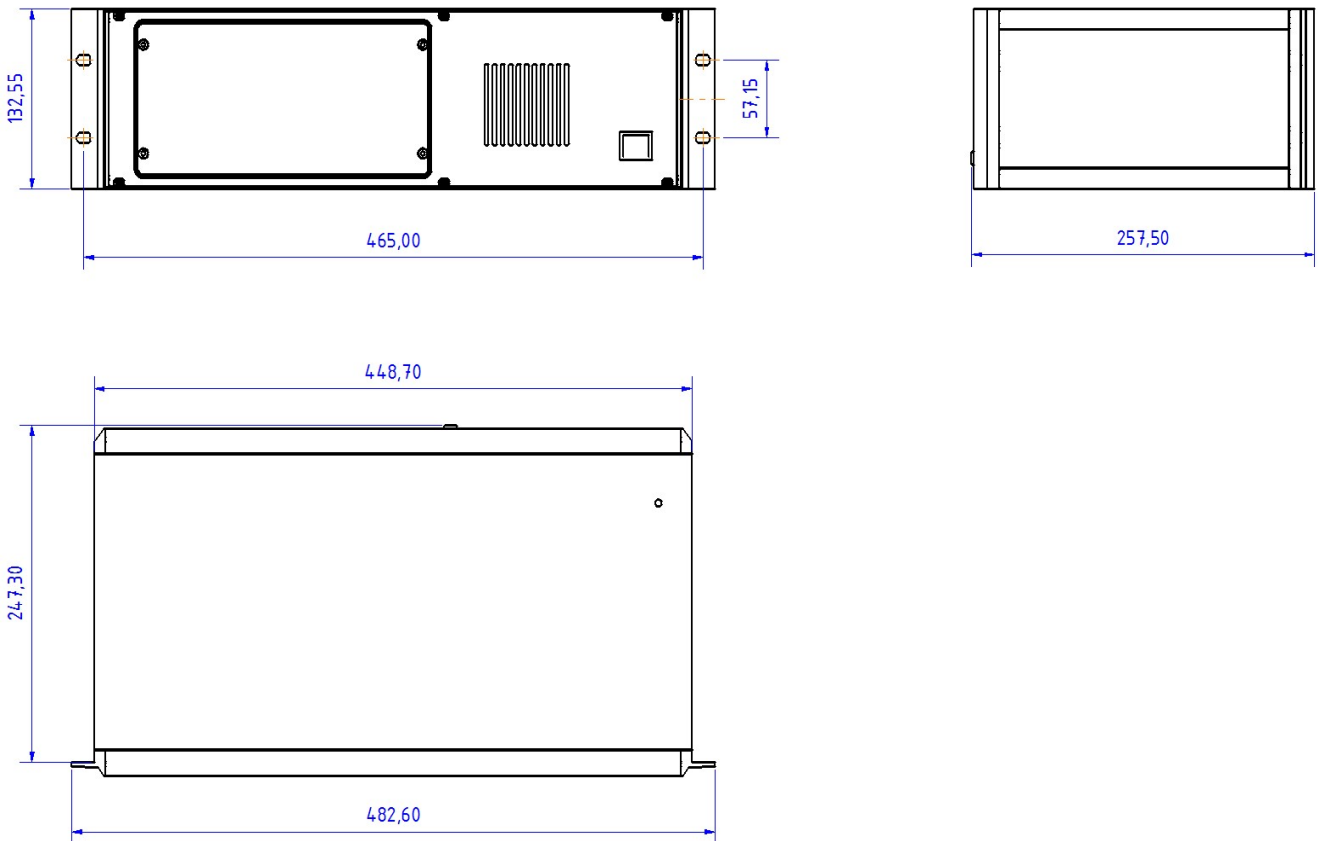

Fig. 179 RT-800, mechanical dimensions (built-in version)

9.2.2 DCU Dimensions (tabletop version)

Measuring units: [mm] millimeters

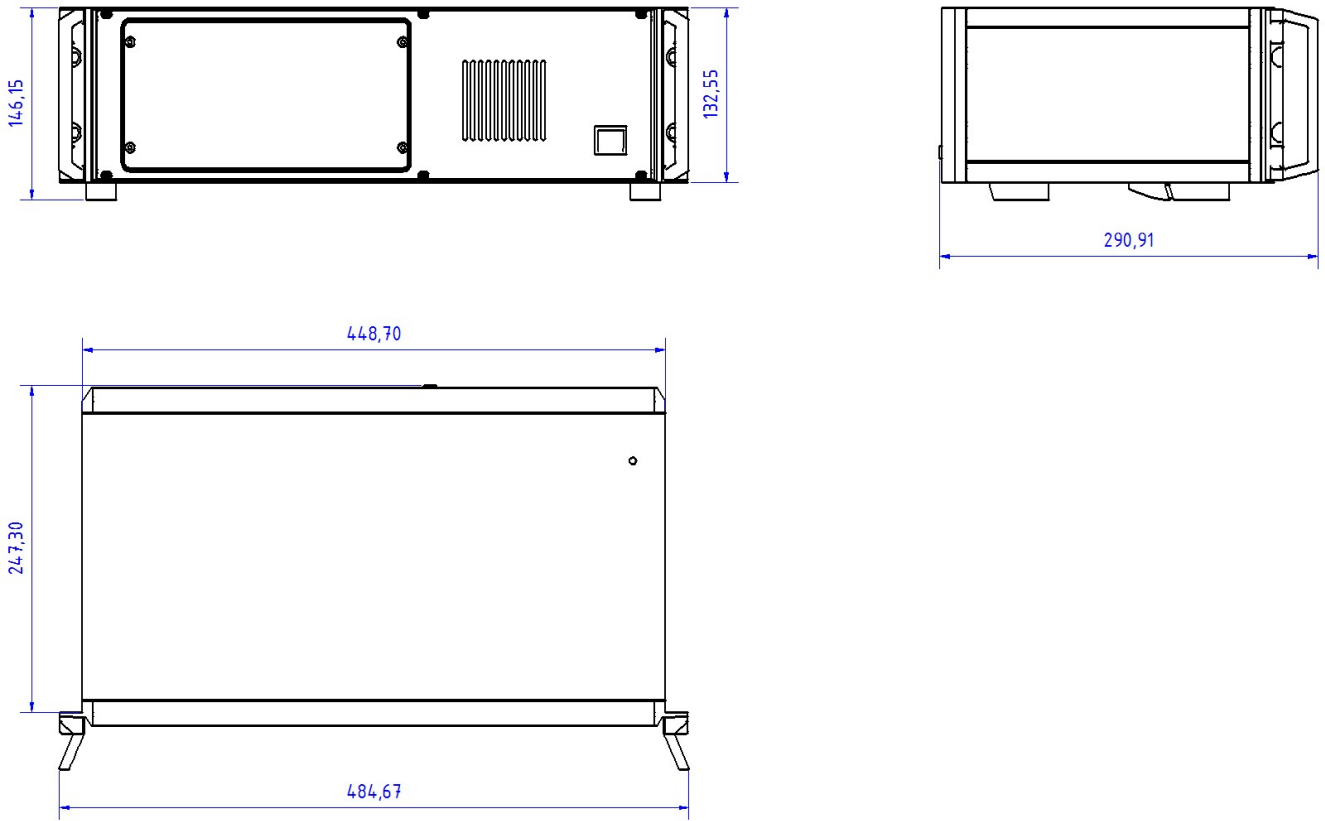

Fig. 180 RT-800, mechanical dimensions (tabletop version)

9.2.3 DCU Mechanical Characteristics

| | |
|---------------------------------|------------------|
| Weight | Approx. 5900 g |
| Permitted operating temperature | -20 °C to +60 °C |
| Permitted storage temperature | -30 °C to +80 °C |

9.2.4 Antenna Unit Dimensions

Measuring units: [mm] millimeters

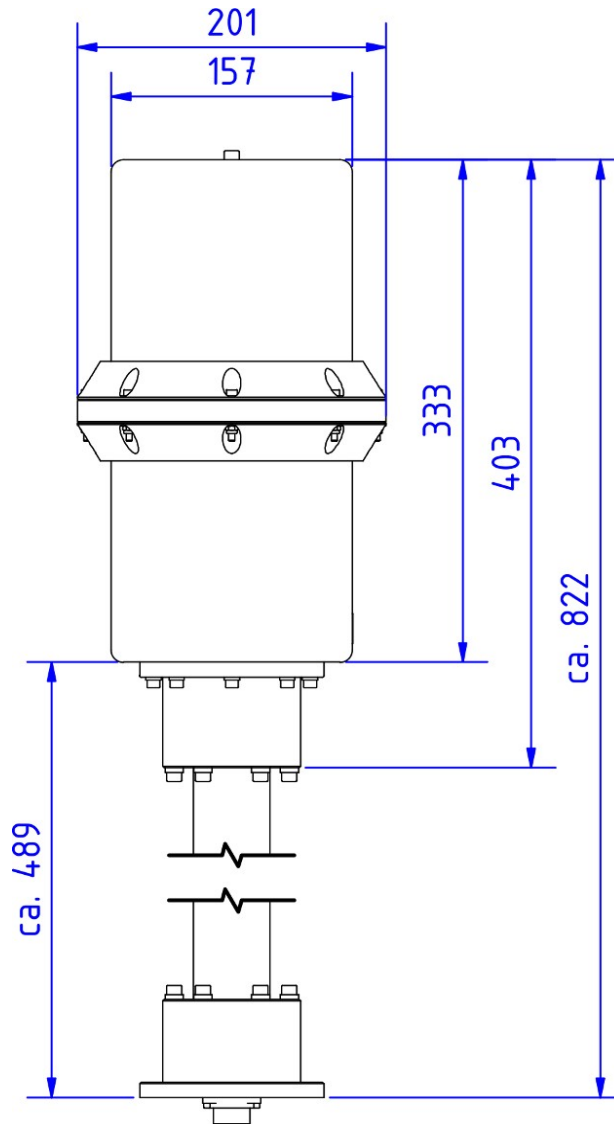

Fig. 181 Antenna Unit, mechanical dimensions

9.2.5 Antenna Unit Mast Flange

Measuring units: [mm] millimeters

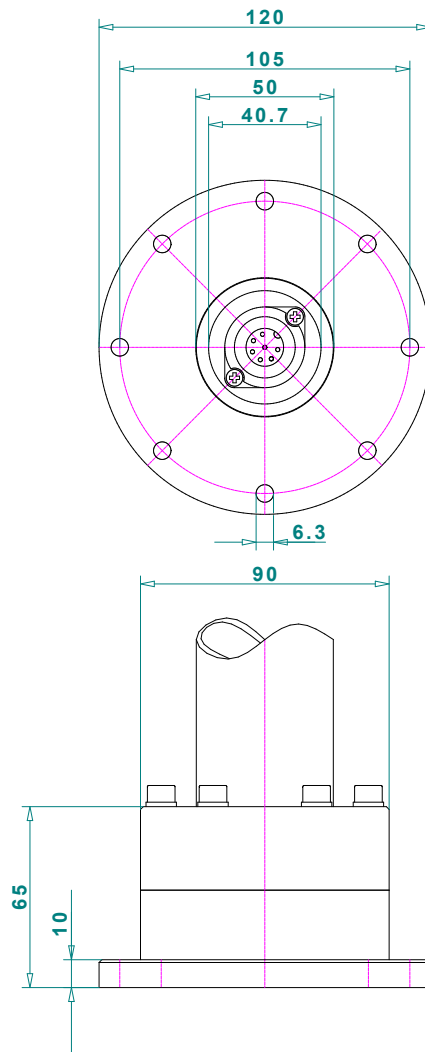

Fig. 182 Antenna Unit, mast flange (mechanical dimensions)

9.2.6 Antenna Unit Mechanical Characteristics

| | |
|---------------------------------|-------------------------------|
| Weight | Approx. 5200 g |
| Permitted operating temperature | -40 °C ¹ to +60 °C |
| Permitted storing temperature | -55 °C to +80 °C |
| Ingress protection | IP 67 |
| Max. wind speed | 270 km/h |

¹ Temperatures below -10°C resp. 14°F may require a warming up time of up to 15 minutes!

10 Disposal within the European Union

Product Recycling



Product labeling in accordance with EN 50419

At the end of the life of the product, this product may not be disposed of with normal household waste. Even disposal via the municipal collection points for electrical and electronic equipment is not allowed.

The correct disposal of this product will help to conserve resources and prevent potential negative effects on the environment and human health which may occur due to improper handling of the product.

- Therefore, carry out the inoperative device, an electronics recycling.
or
- The RHOTHETA Elektronik GmbH takes back all its products, subject to redemption, in accordance with the requirements of the WEEE Directive (2012/19/EU) of the European Union to deliver it to a professional disposal.

11 Disposal outside the European Union

For proper disposal of used electronic equipment in accordance with the respective national regulations in countries outside the European Union please check it with your dealer or the local authorities.

12 Maintenance and Cleaning

12.1 Maintenance

To keep track of time when the device is turned off, a real time clock powered by battery cell is built in the DCU. Discharging of the battery will result in losing track of time. The Real time clock battery replacement every 10 years is recommended.

The exchange of the Lithium battery cell should be done by RHOTHETA Elektronik GmbH or an authorized maintenance facility otherwise, this will void the warranty.

12.2 Cleaning

RHOTHETA Elektronik recommends cleaning the RT-800 with warm water and a cotton or microfiber cloth. Persistent stains can be washed with a dishwashing detergent. Do not use any abrasives or cleaning agents containing alcohol.

13 Appendix

13.1 Error Messages

| Error message | Error location | Cause |
|---|---------------------------------|--|
| Error 01 AU No Receiver | Antenna Unit: Receiver | Defective receiver circuit board in AU |
| Error 04 AU Rec. No PLL | Antenna Unit | Error in receiver synthesizer oscillator in AU |
| Error 05 DCU>AU No Data | Connection Display → Antenna | No serial data from DCU to AU |
| Error 06 DCU>AU BadData | Connection Display → Antenna | Incompatible respective bad data connection between DCU and AU |
| Error 07 AU Low Voltage | Main voltage supply | Voltage supply below 10 V |
| Error 08 AU>DCU BadData | Connection Antenna → Display | Incompatible respective bad data connection between AU and DCU |
| Error 09 No AntennaUnit | Connection Antenna → Display | No serial data (RS485) from AU Missing or damaged cable connection between AU and DCU respective defective AU |
| Error 10 AU Unsupported | Antenna Unit | Antenna Unit is incompatible |
| Error 11 AU Short Circuit! Please connect AU properly and press Clr | Antenna Unit | Incorrect connection of AU (supply short circuit) or very low supply voltage |

13.2 Warnings

| Warning message | Error location | Cause |
|--|---|--|
| Warning 02 NoCompassFound | External device | Compass data not available |
| Warning 10 NMEA DataRange | External device | Incorrect NMEA data: Value out of allowed range |
| Warning 11 NMEA Bad Data | External device | Defective data recognized on NMEA interface |
| Warning 12 NMEA CheckSum | External device | Defective data recognized on NMEA interface: Check Sum |
| Warning 13 NMEA Bad Frame | External device | Defective data recognized on NMEA interface: Bad Frame |
| Warning 20 AU DataRange | Connection Display → Antenna | Bad data of DCU, mismatch of telegram length |
| Warning 21 AU Decode Err | Radio distance transmitter ↔ direction finder | Data error in Cospas-Sarsat data block, data could not be decoded. |
| Warning 22 AU Offset Dev -8 kHz | Received transmitter | Frequency of transmitter too low |
| Warning 23 AU Offset Dev +8 kHz | Received transmitter | Frequency of transmitter too high |
| Warning 31 Temperature is too high! | Display Control Unit | Temperature of the DCU too high |

13.3 Setup Tree View (Settings)

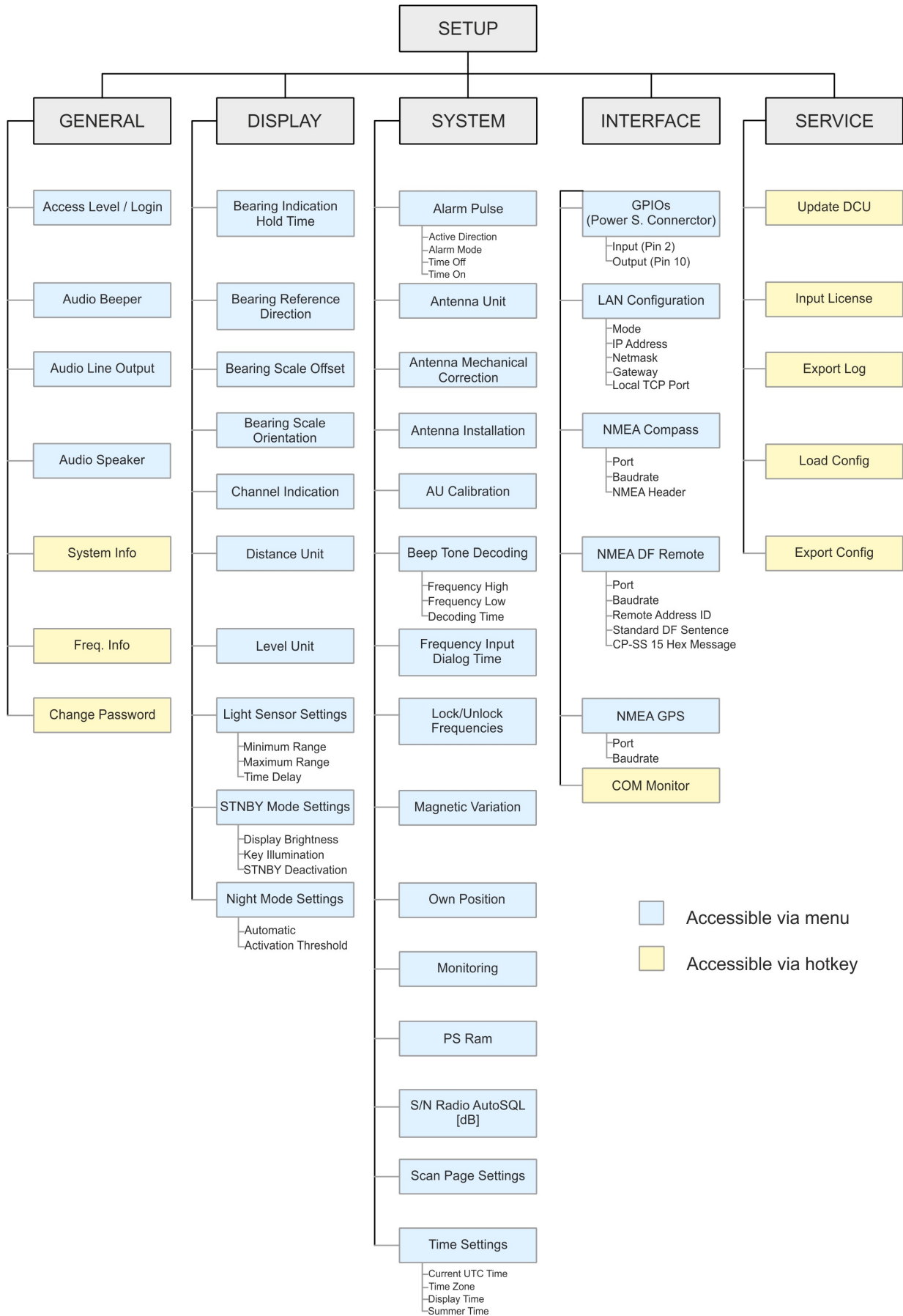

13.4 Default / User System Configuration Table

| System Configuration | | |
|-------------------------------|--|------------|
| Setting / Parameter | Default Value | User Value |
| SETUP -> GENERAL | | |
| Access Level / Login | Administrator | |
| Audio Beeper | Beeper Key Pressing On | |
| Audio Line Output | 75% | |
| Audio Speaker | External | |
| SETUP -> DISPLAY | | |
| Bearing Indication Hold Time | 2 sec | |
| Bearing Reference Direction | True | |
| Bearing Scale Offset | 0° | |
| Bearing Scale Orientation | Compass | |
| Channel Indication | Channel | |
| Distance Unit | km | |
| Level Unit | % | |
| Light Sensor Settings | Minimum Range: 0 Maximum Range: 100 Time Delay: 20 sec | |
| STNBY Mode Settings | Display Brightness: Off Key Illumination: On STNBY Deactivation: Automatic | |
| Night Mode Settings | Automatic: Off Activation Threshold: 15% | |
| SETUP -> SYSTEM | | |
| Alarm Pulse | Active Direction: High Alarm Mode: Pulse Time Off: 5 sec Time On: 5 sec | |
| Antenna Unit | Standard Mounting | |
| Antenna Mechanical Correction | 0° | |
| Antenna Installation | Fixed Installation | |
| AU Calibration | Calibration On | |

| System Configuration | | |
|---|---|-------------------|
| Setting / Parameter | Default Value | User Value |
| Beep Tone Decoding | Frequency High: 900 Hz Frequency Low: 700 Hz Decoding Time: 200 ms | |
| Frequency Input Dialog Time | 10 sec | |
| Lock / Unlock Frequencies | No Frequencies Locked | |
| Magnetic Variation | Disabled | |
| MOB Trigger | Only Manually | |
| Monitoring | On / Off by User | |
| Own Position | Disabled | |
| PS Ram | Compass Compensation On | |
| S/N Ratio AutoSQL [dB] | 6 | |
| Scan Page Settings | OK: Stay on Scan Page | |
| Time Settings | Current UTC Time: hh:mm:ss Timezone: UTC +00:00 Display Time: Local Summer Time: Off | |
| SETUP -> INTERFACE | | |
| GPIOs (Power S. Connector) | Input (Pin 2): PTT Output (Pin 10): Alarm Out | |
| LAN Configuration (DCU connector s. Fig. 3, position 7) | Mode: Static IP Address: 192.168.77.208 Netmask: 255.255.255.0 Gateway: 192.168.77.1 Local TCP Port: 9999 | |
| NMEA Compass | Port: No Compass Baudrate: 4800 NMEA Header: \$xxHDT | |
| NMEA DF Remote | Port: COM3/LAN Baudrate: 4800 Remote Address ID: 0 | |
| NMEA GPS | Port: no GPS Baudrate: 4800 | |

13.5 Scan Page Tree View (Settings)

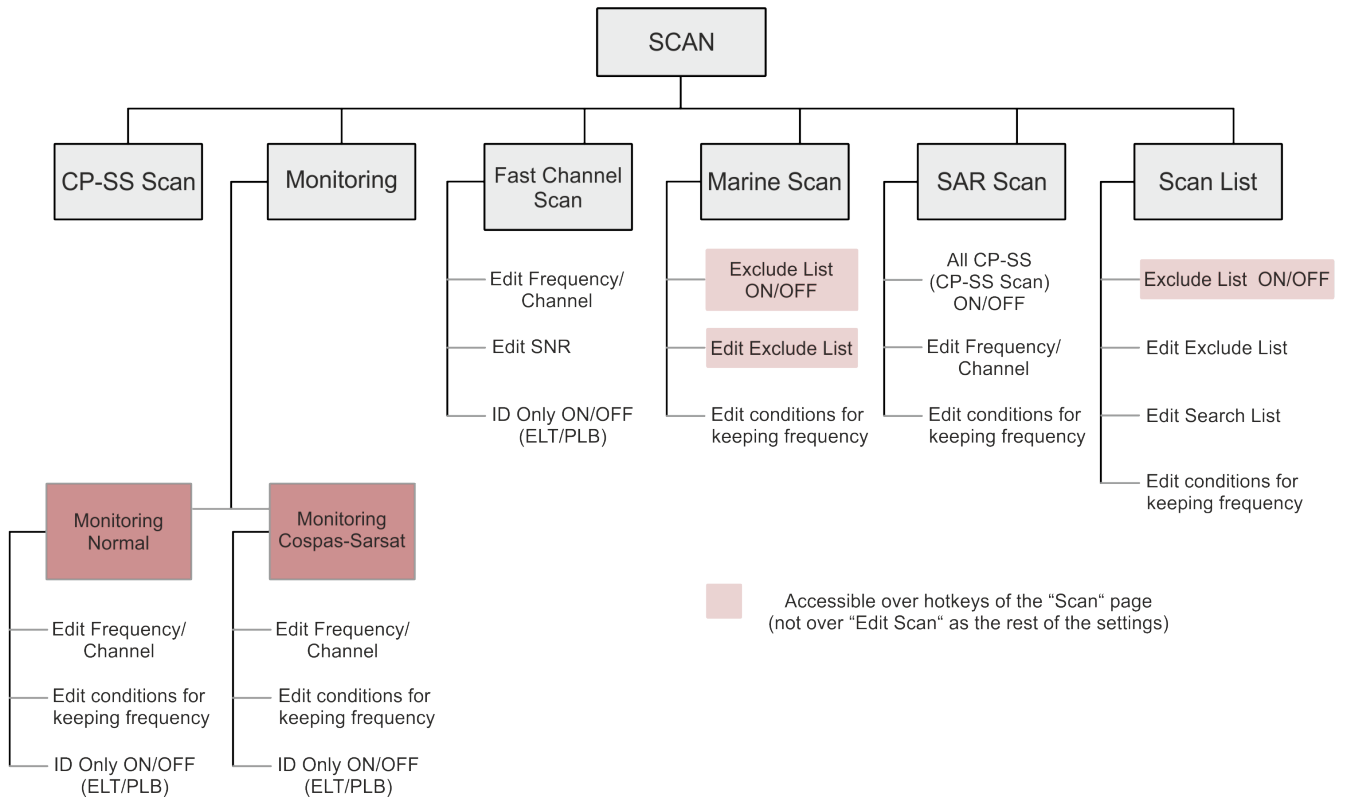

13.6 Frequencies of channels on maritime band

| Channel No. | frequency (ship - station) | Frequency (coast - station) |
|-------------|----------------------------|-----------------------------|
| 0 | 156,000 MHz | 160,600 MHz |
| 1 | 156,050 MHz | 160,650 MHz |
| 2 | 156,100 MHz | 160,700 MHz |
| 3 | 156,150 MHz | 160,750 MHz |
| 4 | 156,200 MHz | 160,800 MHz |
| 5 | 156,250 MHz | 160,850 MHz |
| 6 | 156,300 MHz | 160,900 MHz |
| 7 | 156,350 MHz | 160,950 MHz |
| 8 | | 156,400 MHz |
| 9 | | 156,450 MHz |
| 10 | | 156,500 MHz |
| 11 | | 156,550 MHz |
| 12 | | 156,600 MHz |
| 13 | | 156,650 MHz |
| 14 | | 156,700 MHz |
| 15 | | 156,750 MHz |
| 16 | | 156,800 MHz |
| 17 | | 156,850 MHz |
| 18 | 156,900 MHz | 161,500 MHz |
| 19 | 156,950 MHz | 161,550 MHz |
| 20 | 157,000 MHz | 161,600 MHz |
| 21 | 157,050 MHz | 161,650 MHz |
| 22 | 157,100 MHz | 161,700 MHz |
| 23 | 157,150 MHz | 161,750 MHz |
| 24 | 157,200 MHz | 161,800 MHz |
| 25 | 157,250 MHz | 161,850 MHz |
| 26 | 157,300 MHz | 161,900 MHz |
| 27 | 157,350 MHz | 161,950 MHz |
| 28 | 157,400 MHz | 162,000 MHz |
| 60 | 156,025 MHz | 160,625 MHz |
| 61 | 156,075 MHz | 160,675 MHz |
| 62 | 156,125 MHz | 160,725 MHz |
| 63 | 156,175 MHz | 160,775 MHz |
| 64 | 156,225 MHz | 160,825 MHz |
| 65 | 156,275 MHz | 160,875 MHz |
| 66 | 156,325 MHz | 160,925 MHz |
| 67 | | 156,375 MHz |
| 68 | | 156,425 MHz |
| 69 | | 156,475 MHz |
| 70 | | 156,525 MHz |
| 71 | | 156,575 MHz |
| 72 | | 156,625 MHz |
| 73 | | 156,675 MHz |
| 74 | | 156,725 MHz |
| 75 | | 156,775 MHz |
| 76 | | 156,825 MHz |
| 77 | | 156,875 MHz |
| 78 | 156,925 MHz | 161,525 MHz |
| 79 | 156,975 MHz | 161,575 MHz |
| 80 | 157,025 MHz | 161,625 MHz |
| 81 | 157,075 MHz | 161,675 MHz |
| 82 | 157,125 MHz | 161,725 MHz |
| 83 | 157,175 MHz | 161,775 MHz |
| 84 | 157,225 MHz | 161,825 MHz |
| 85 | 157,275 MHz | 161,875 MHz |
| 86 | 157,325 MHz | 161,925 MHz |
| 87 | 157,375 MHz | 161,975 MHz |
| 88 | 157,425 MHz | 162,025 MHz |

13.7 Channel Spacing UHF / VHF Air Band

The frequency input has to be performed according to ICAO Annex 10 Volume V clause 4.1.2.4 table 4.1. Please note that it is possible to work on channel spacing: 8.33 as well as 25 kHz. This is necessary because channel spacing 8.33 kHz and 25 kHz exist at the same time. Inside the receiver, the signal filtering is switched in accordance to the selected channel spacing.

The input scheme according to ICAO Annex 10 Volume V clause 4.1.2.4 table 4.1 is illustrated by the following example:

| Frequency Setting / -Display [MHz] | Channel Spacing | Bandwidth | Receiving Frequency [MHz] |
|---------------------------------------|-----------------|-----------|---------------------------------|
| 118,000 | 25 kHz | wide | 118,0000 |
| 118,005 | 8,33 kHz | narrow | 118,0000 |
| 118,010 | 8,33 kHz | narrow | 118,0083 |
| 118,015 | 8,33 kHz | narrow | 118,0167 |
| 118,020 | Not valid | | |
| 118,025 | 25 kHz | wide | 118,0250 |
| 118,030 | 8,33 kHz | narrow | 118,0250 |
| 118,035 | 8,33 kHz | narrow | 118,0333 |
| 118,040 | 8,33 kHz | narrow | 118,0417 |
| 118,045 | Not valid | | |
| 118,050 | 25 kHz | wide | 118,0500 |
| 118,055 | 8,33 kHz | narrow | 118,0500 |
| 118,060 | 8,33 kHz | narrow | 118,0583 |
| 118,065 | 8,33 kHz | narrow | 118,0667 |
| 118,070 | Not valid | | |
| 118,075 | 25 kHz | wide | 118,0750 |
| 118,080 | 8,33 kHz | narrow | 118,0750 |
| 118,085 | 8,33 kHz | narrow | 118,0833 |
| 118,090 | 8,33 kHz | narrow | 118,0917 |
| 118,095 | Not valid | | |
| 118,100 | 25 kHz | wide | 118,1000 |
| 118,105 | 8,33 kHz | narrow | 118,1000 |
| • | • | • | • |
| • | • | • | • |
| • | • | • | • |
| xxx,x00 | 25 kHz | wide | xxx,x000 |
| xxx,x05 | 8,33 kHz | narrow | xxx,x000 |
| xxx,x10 | 8,33 kHz | narrow | xxx,x833 |
| xxx,x15 | 8,33 kHz | narrow | xxx,x167 |
| xxx,x20 | Not valid | | |
| xxx,x25 | 25 kHz | wide | xxx,x250 |
| xxx,x30 | 8,33 kHz | narrow | xxx,x250 |
| xxx,x35 | 8,33 kHz | narrow | xxx,x333 |
| xxx,x40 | 8,3 3kHz | narrow | xxx,x417 |
| xxx,x45 | Not valid | | |

| Frequency Setting / -Display [MHz] | Channel Spacing | Bandwidth | Receiving Frequency [MHz] |
|---------------------------------------|-----------------|-----------|---------------------------------|
| xxx,x50 | 25 kHz | wide | xxx,x500 |
| xxx,x55 | 8,33 kHz | narrow | xxx,x500 |
| xxx,x60 | 8,33 kHz | narrow | xxx,x583 |
| xxx,x65 | 8,33 kHz | narrow | xxx,x667 |
| xxx,x70 | Not valid | | |
| xxx,x75 | 25 kHz | wide | xxx,x750 |
| xxx,x80 | 8,33 kHz | narrow | xxx,x750 |
| xxx,x85 | 8,33 kHz | narrow | xxx,x833 |
| xxx,x90 | 8,33 kHz | narrow | xxx,x917 |
| xxx,x95 | Not valid | | |

13.8 Abbreviations

| Abbreviation | Meaning | Remarks |
|--------------|---|---------------------------------------|
| AU | Antenna Unit | |
| CP-SS | Cospas-Sarsat | |
| DCU | Display & Control Unit | |
| DF | Direction finder | |
| Deg | Degree (° = 60') | |
| ELT | Emergency Locator Transmitter | |
| GND | Ground | |
| GPS | Global Positioning System | |
| ID | Identification | |
| IP | Ingress Protection rating | IP67 |
| LAN | Local Area Network | |
| LCD | Liquid Crystal Display | |
| LED | Light-Emitting Diode | |
| MOB | Man-Over-Board | |
| MMSI | Maritime Mobile Service Identity | Ship's Ident. No. |
| NF | Audio Frequency | |
| NMEA (0183) | National Marine Electronics Association | Interface- and data telegram standard |
| PLB | Personal Locator Beacon | |
| PS RAM | Averaging Random Access Memory | |
| PTT/SBS | Push-To-Talk/ Self Bearing Suppression | |
| RAM | Random Access Memory | |
| Rx | Receiver | |
| S/N | Signal to Noise | |
| SAR | Search And Rescue | |
| SNR | Signal to Noise-Ratio | |
| SQL | Squelch | |
| TFT | Thin Film Transistor (see also LCD) | |
| Tx | Transmitter | |
| VDC | Volts of Direct Current | |
| VTS | Vessel Traffic Service | |